

Kupfertafeln

zum

Handbuch der Wasserbaukunst

von

G. Hagen.

Dritter Theil.

Seeufer- und Hafen-Bau.

Vierter Band.

Berlin 1865.

Verlag von Ernst & Korn.

(Gropius'sche Buch- und Kunsthandlung.)

Fig. 182. b.

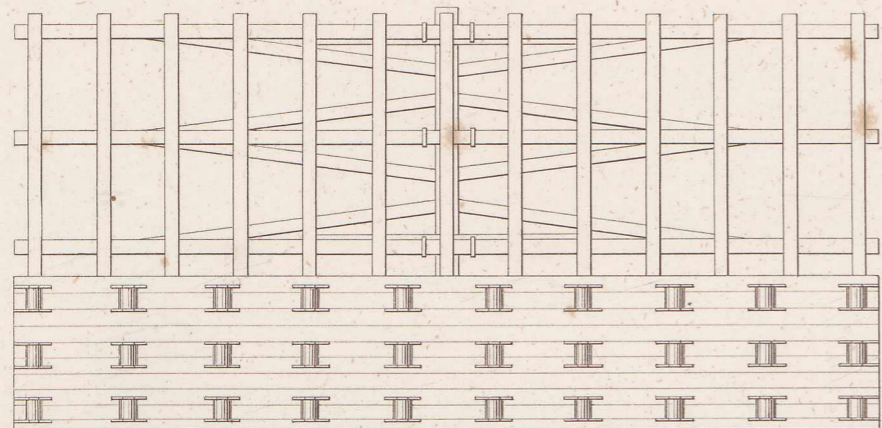

Fig. 182. a.

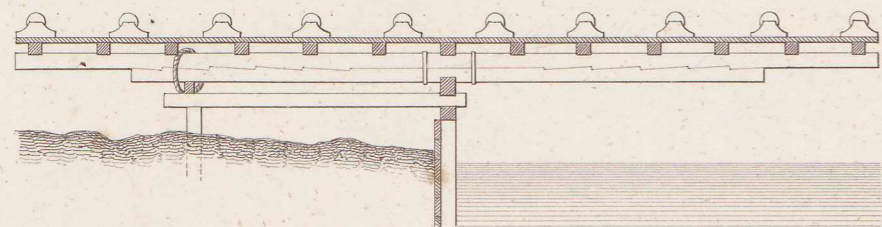

Fig. 184. b.

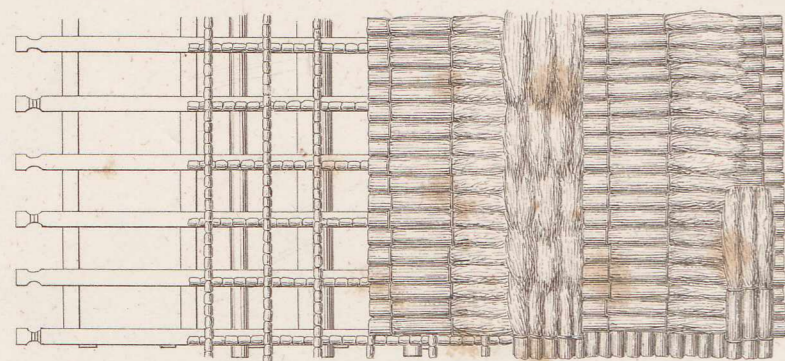
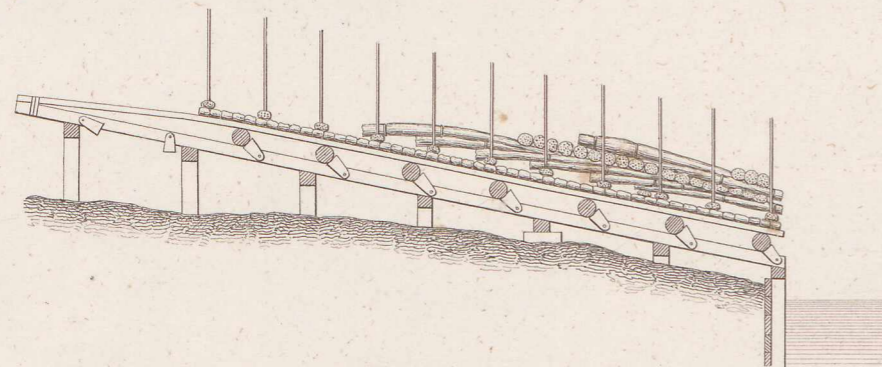

Fig. 184. a.



zu Fig. 182 u. 184.

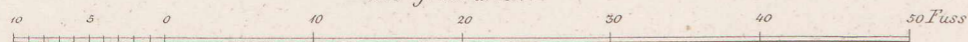

Fig. 185. a.

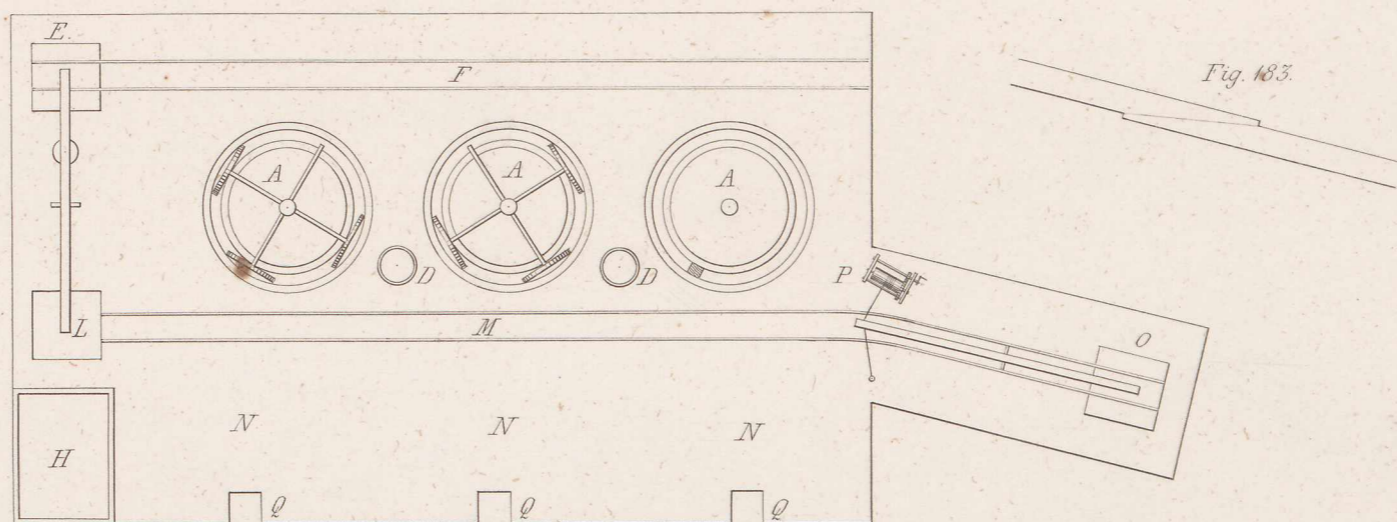

Fig. 183.

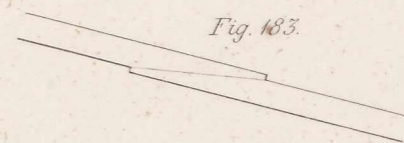

Fig. 185. b.

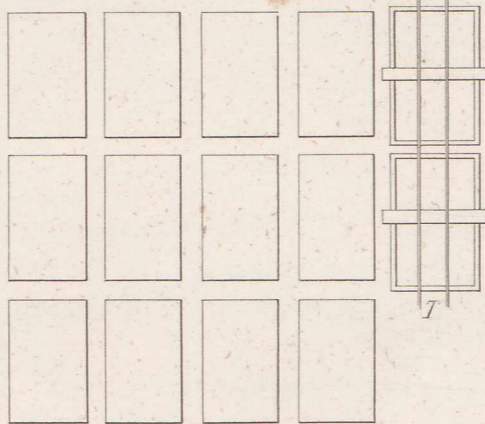
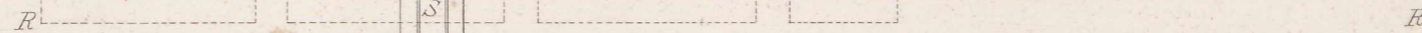
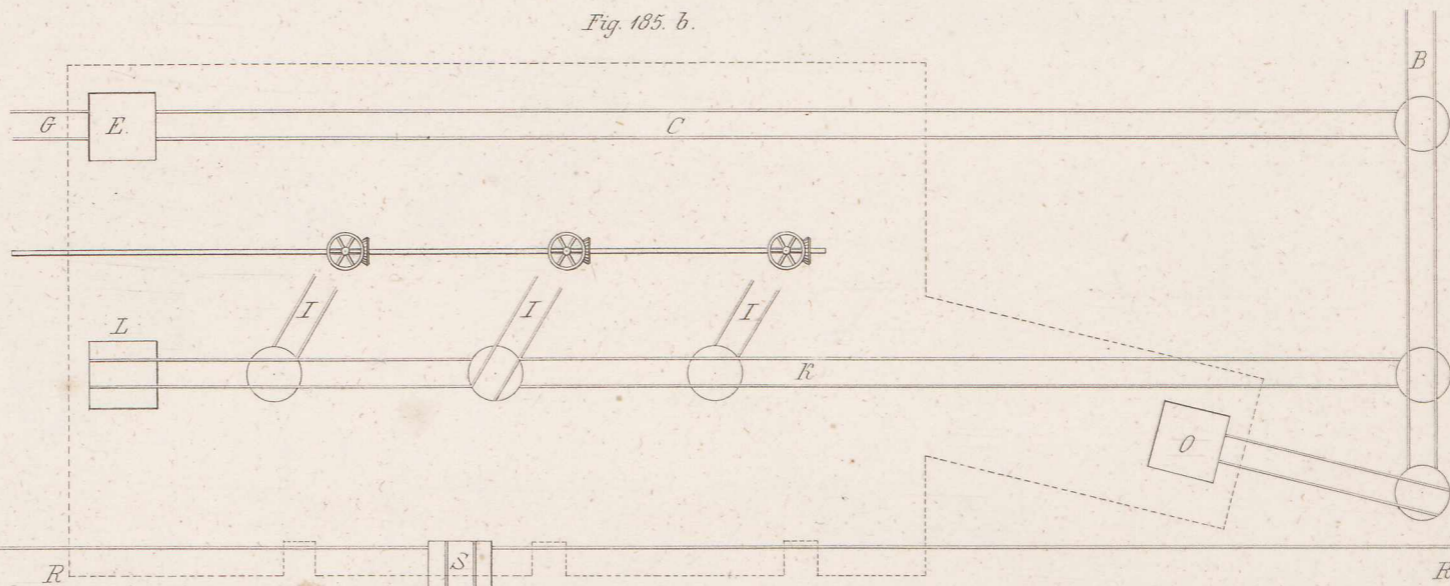

Fig. 187.



Fig. 181.

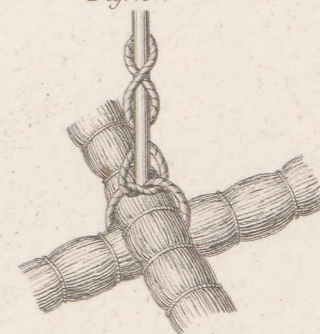
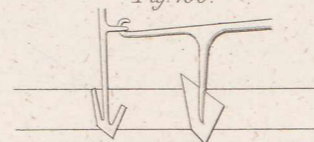

Fig. 186.



zu Fig. 185.

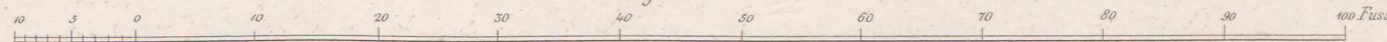
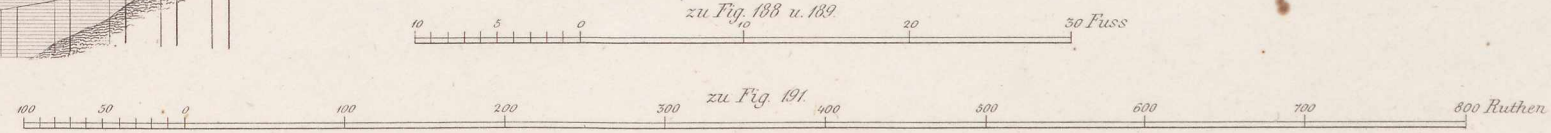
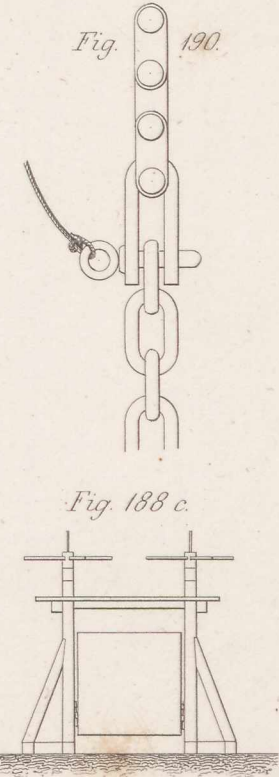
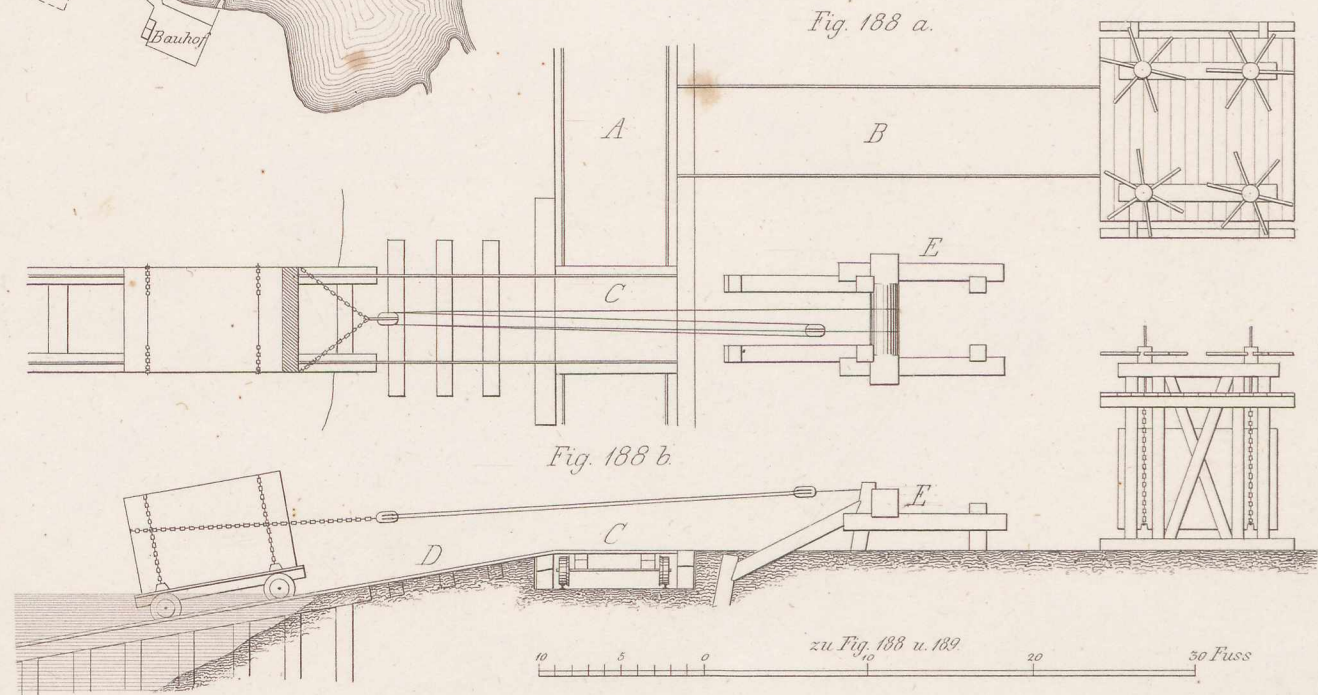
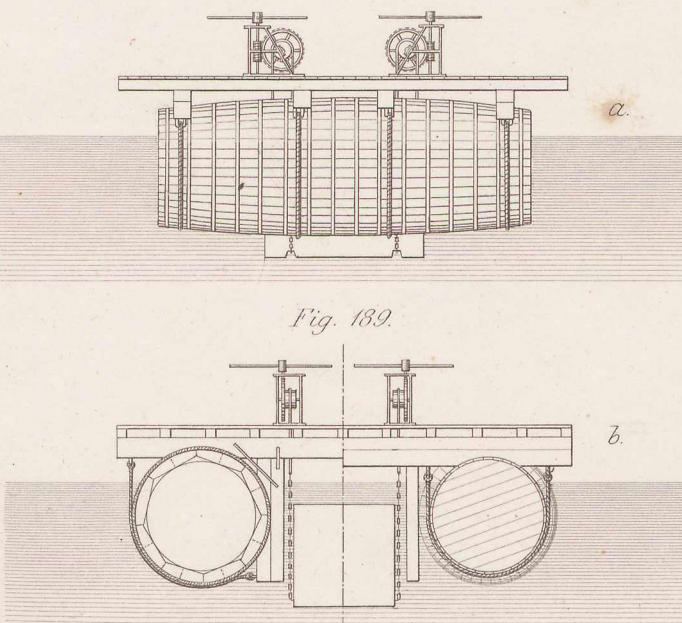
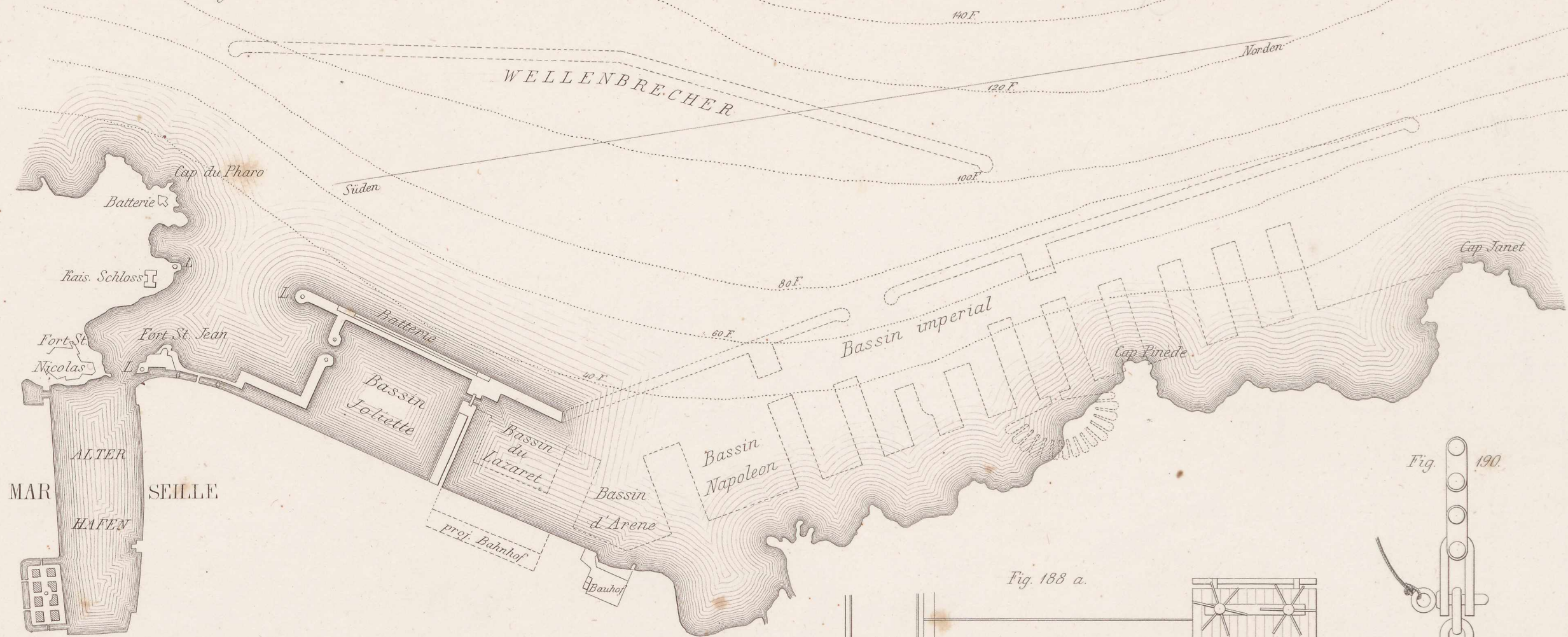

Fig. 191.



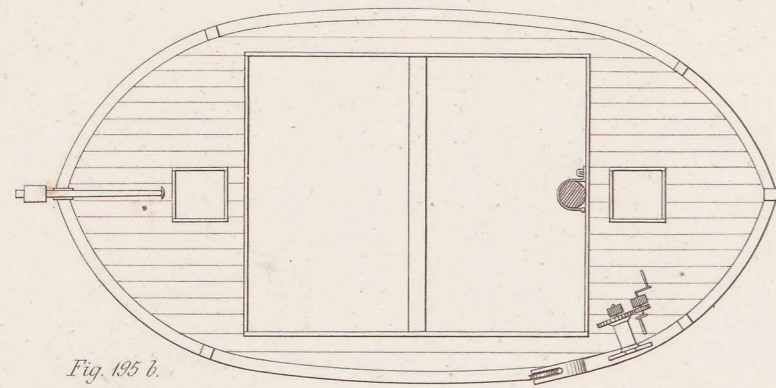

Fig. 195 b.

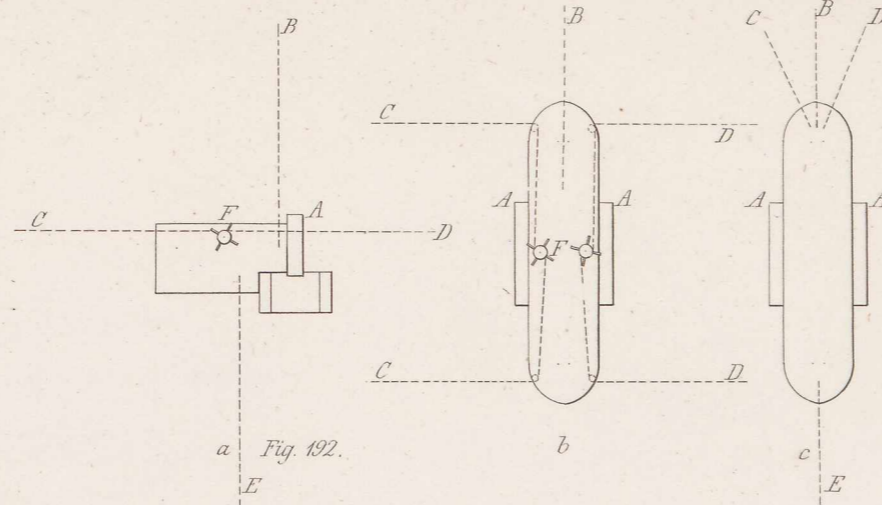

Fig. 192.

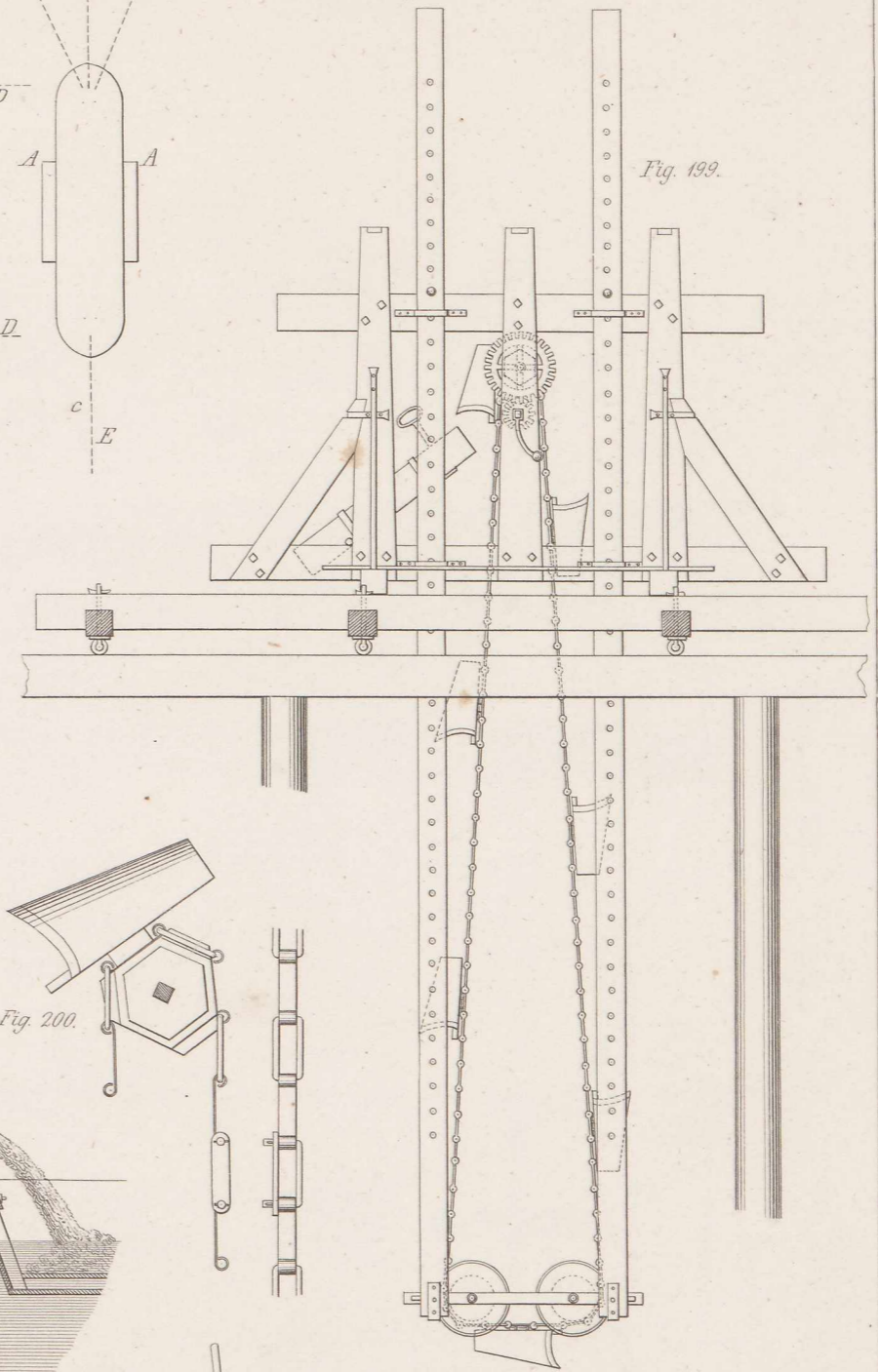

Fig. 199.

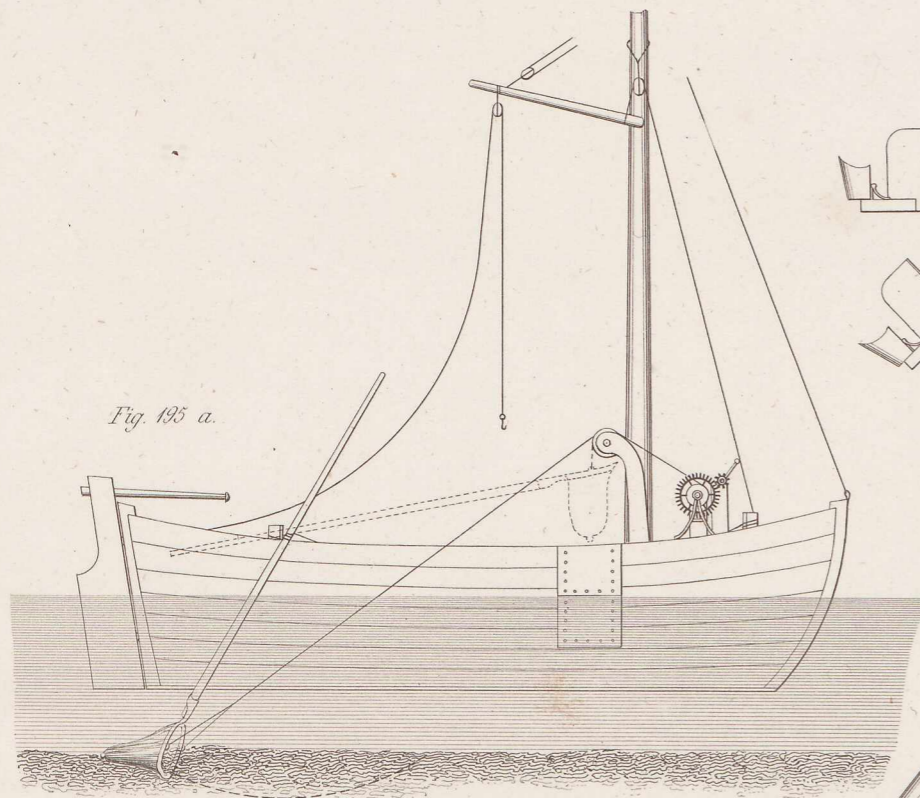

Fig. 195 a.

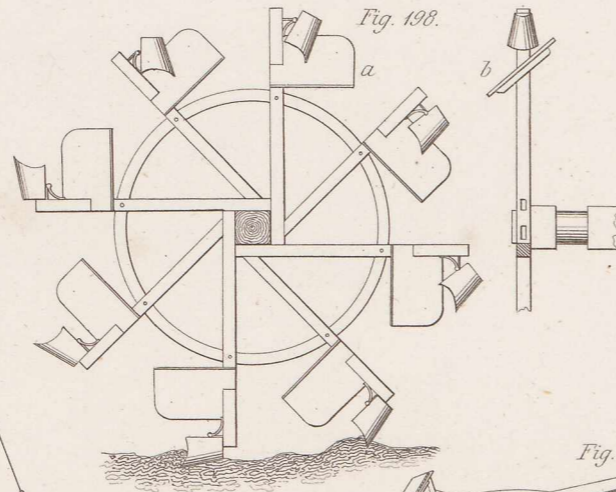

Fig. 198.

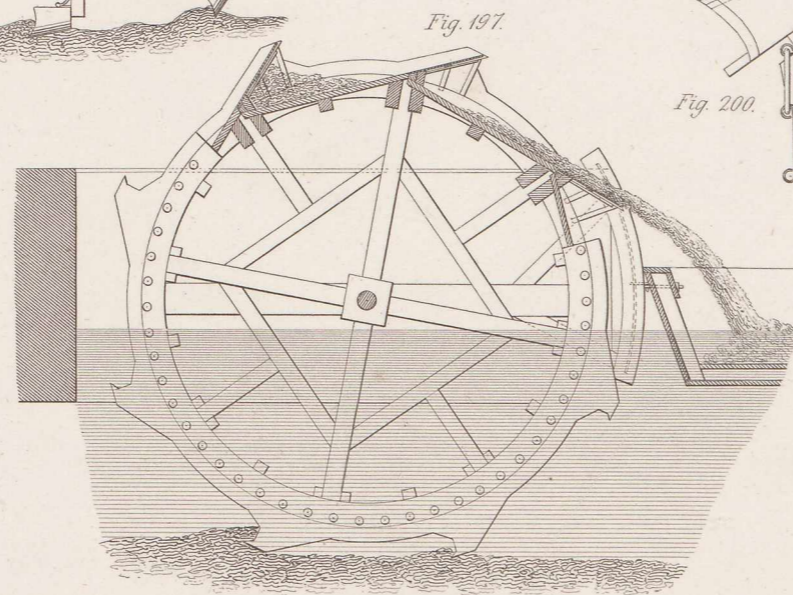

Fig. 197.

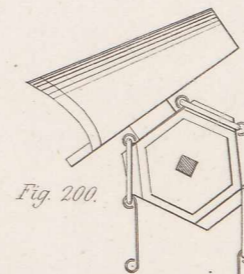

Fig. 200.

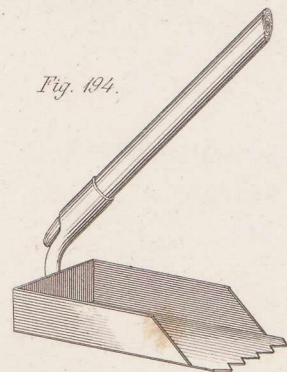

Fig. 194.

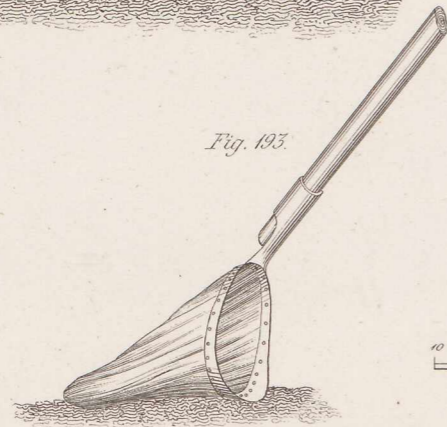
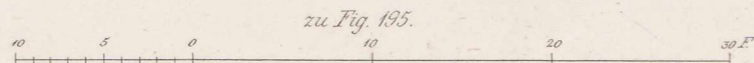
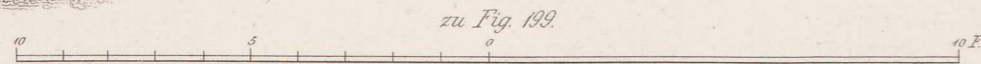

Fig. 195.



zu Fig. 195.



zu Fig. 199.

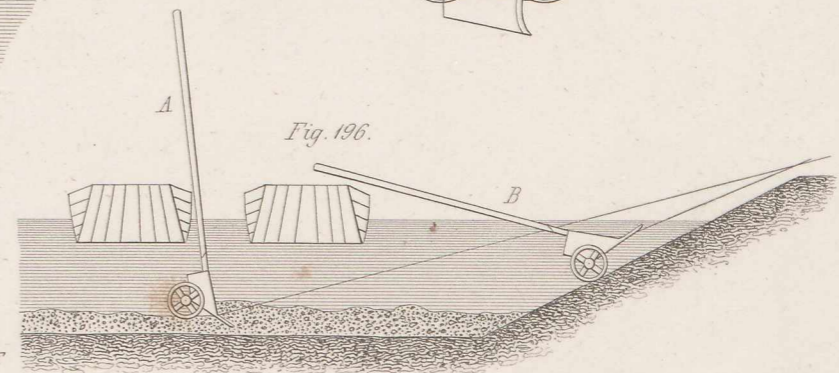

Fig. 196.

Fig. 203 a.

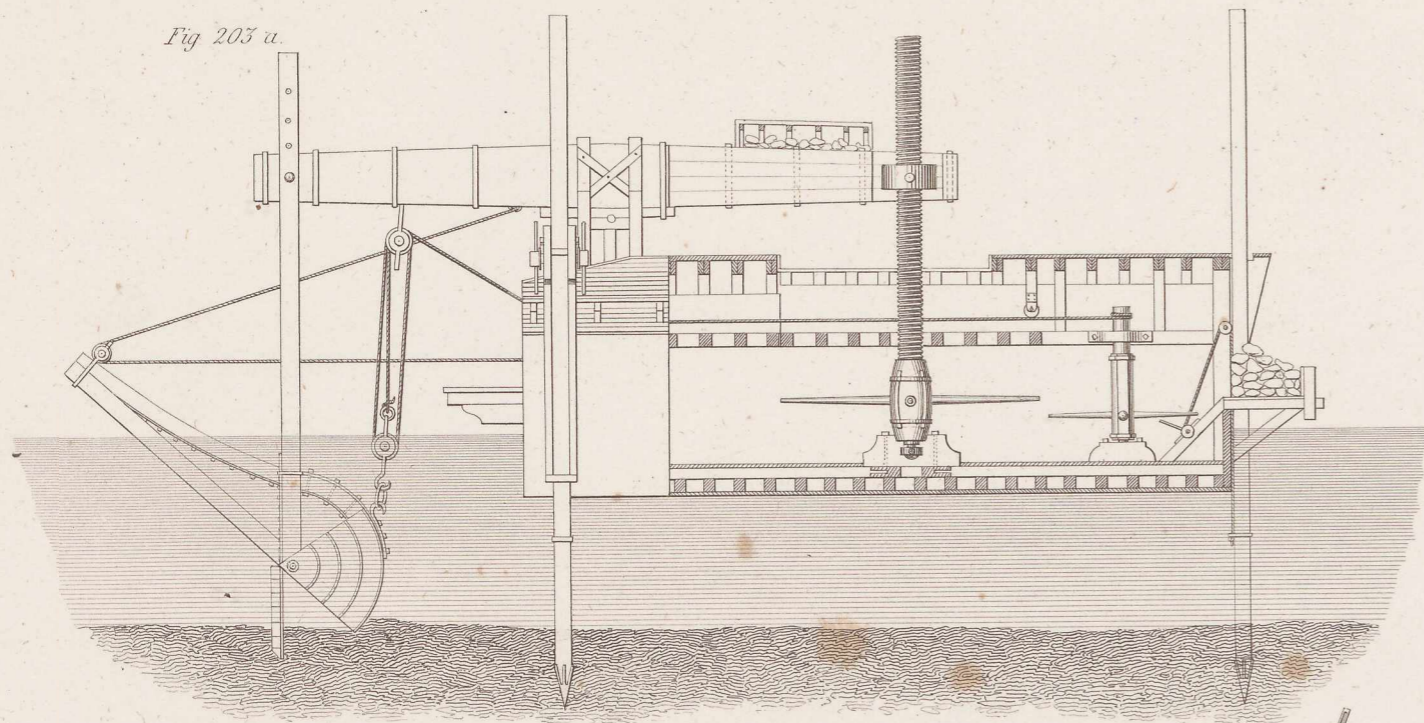

Fig. 201 a.

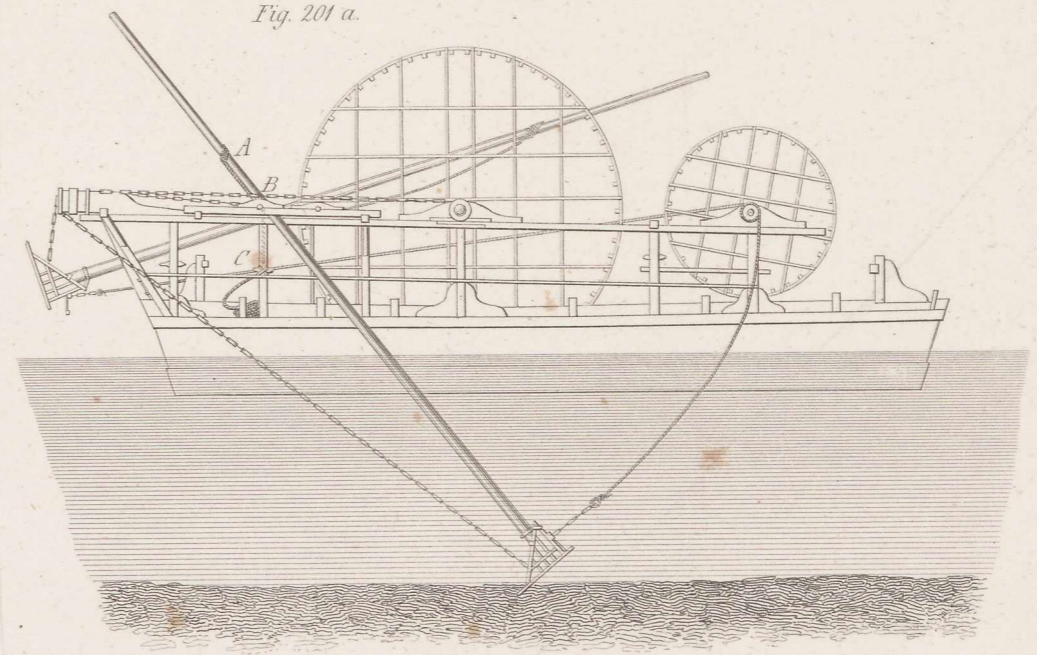

Fig. 204.

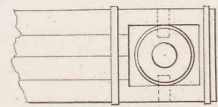

Fig. 203 b.

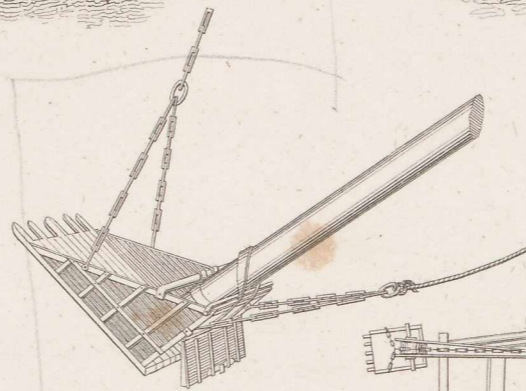
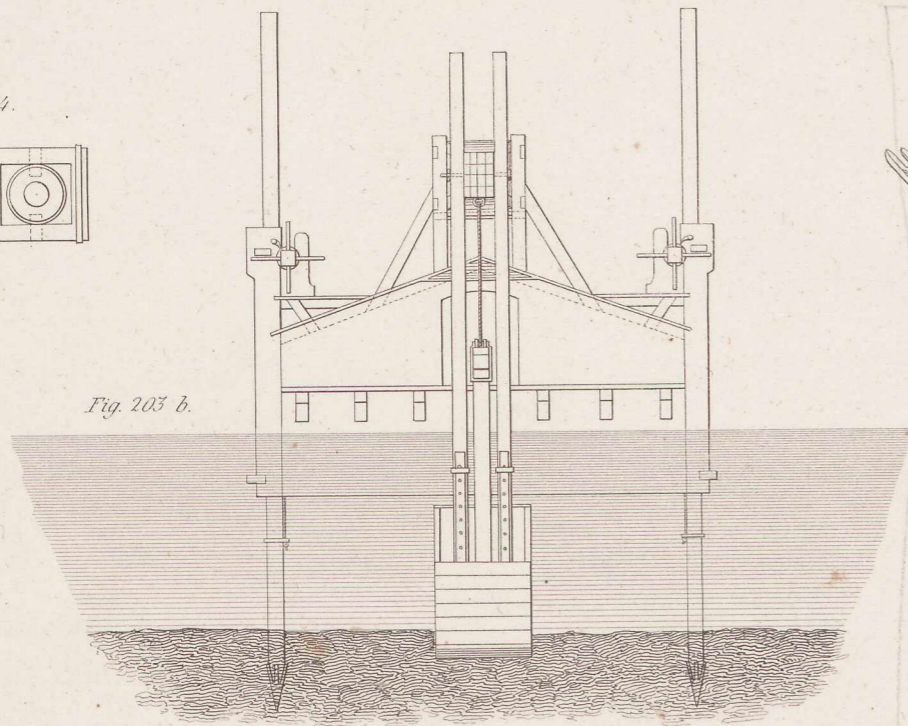
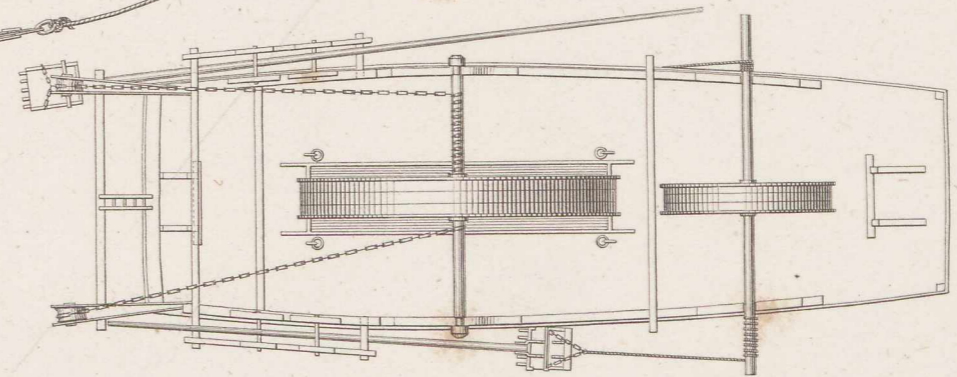

Fig. 202.

Fig. 201 b.



zu Fig. 201 und 203.

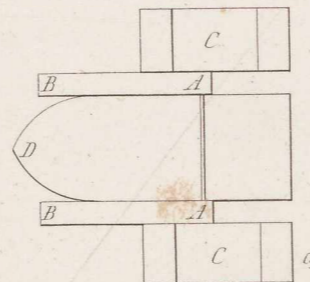
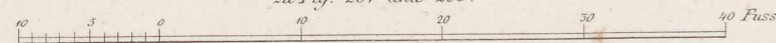
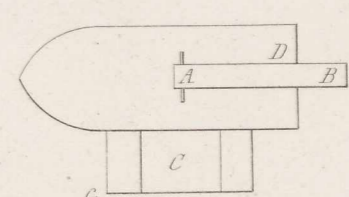
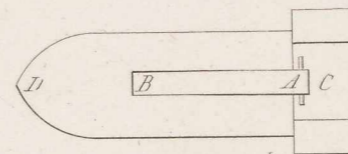

Fig. 205 b.



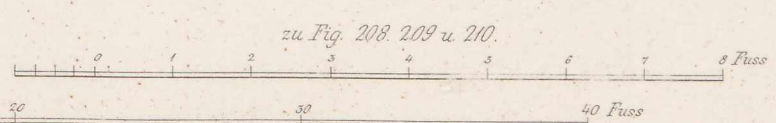
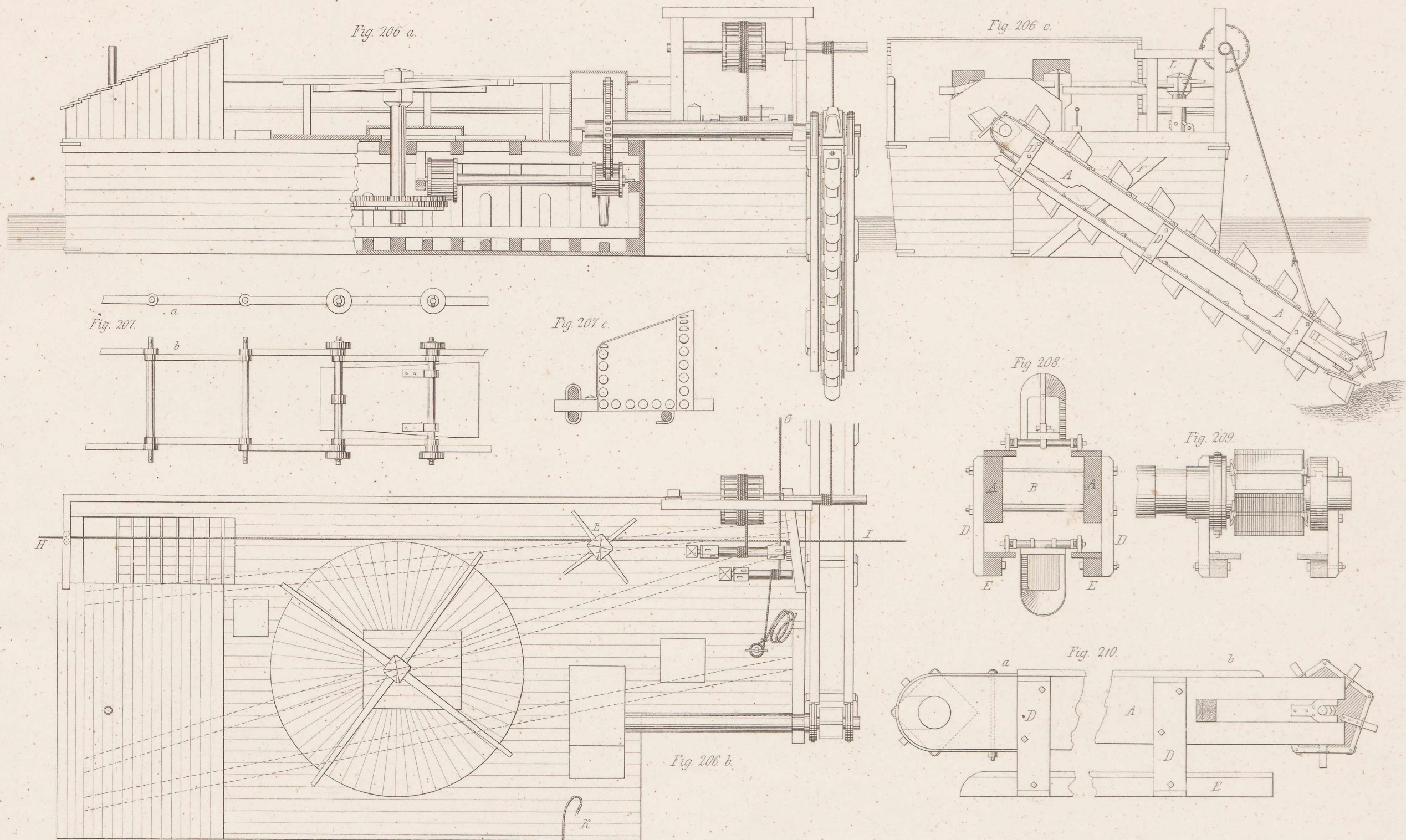

Fig. 212.

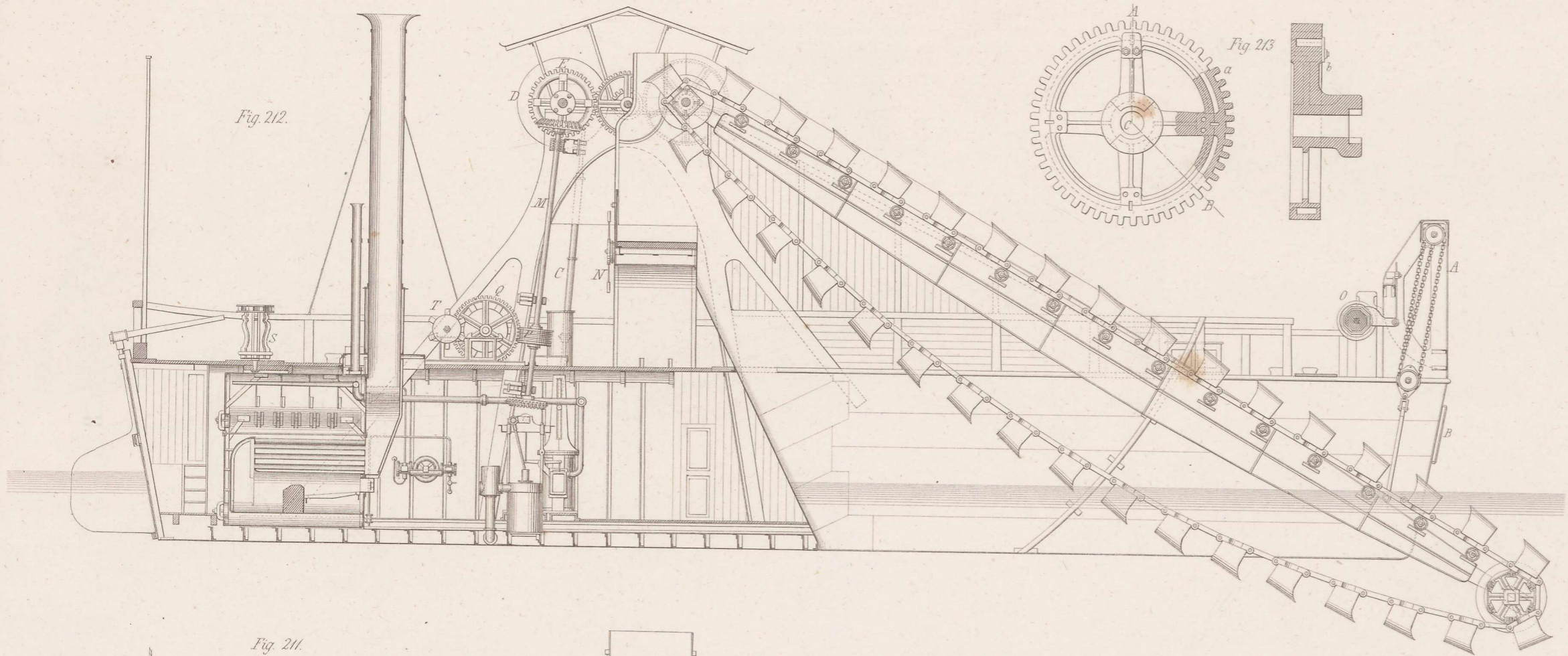
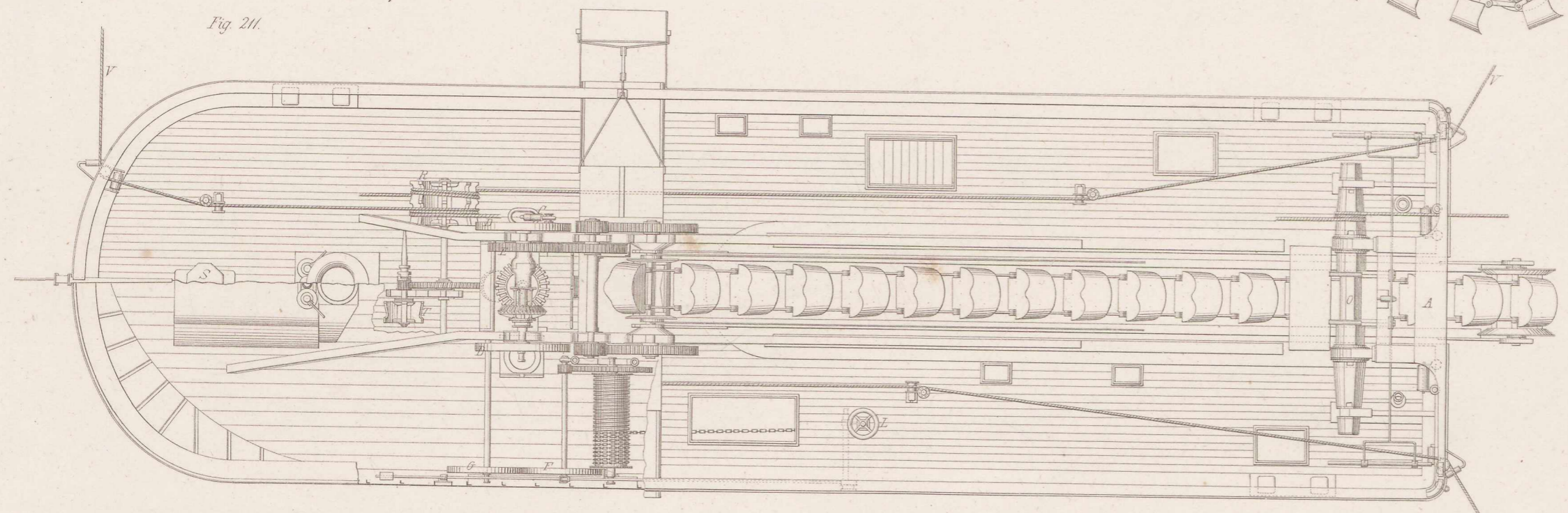

Fig. 211.



zu Fig. 211 u. 212.
 10 9 8 7 6 5 4 3 2 1 0 20 30 Fuss

Fig. 214.

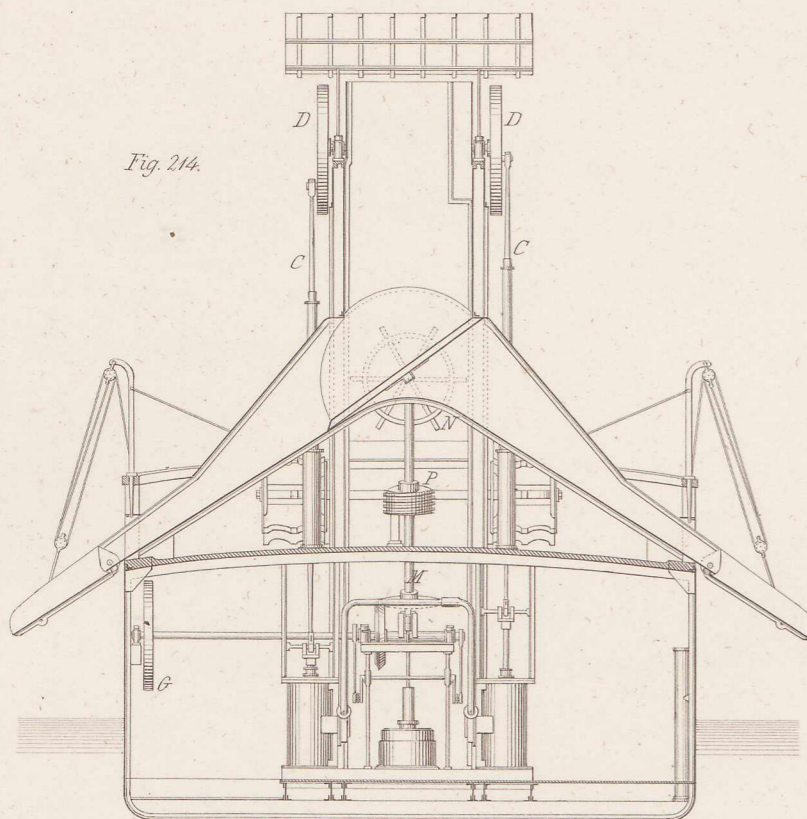

Fig. 215.

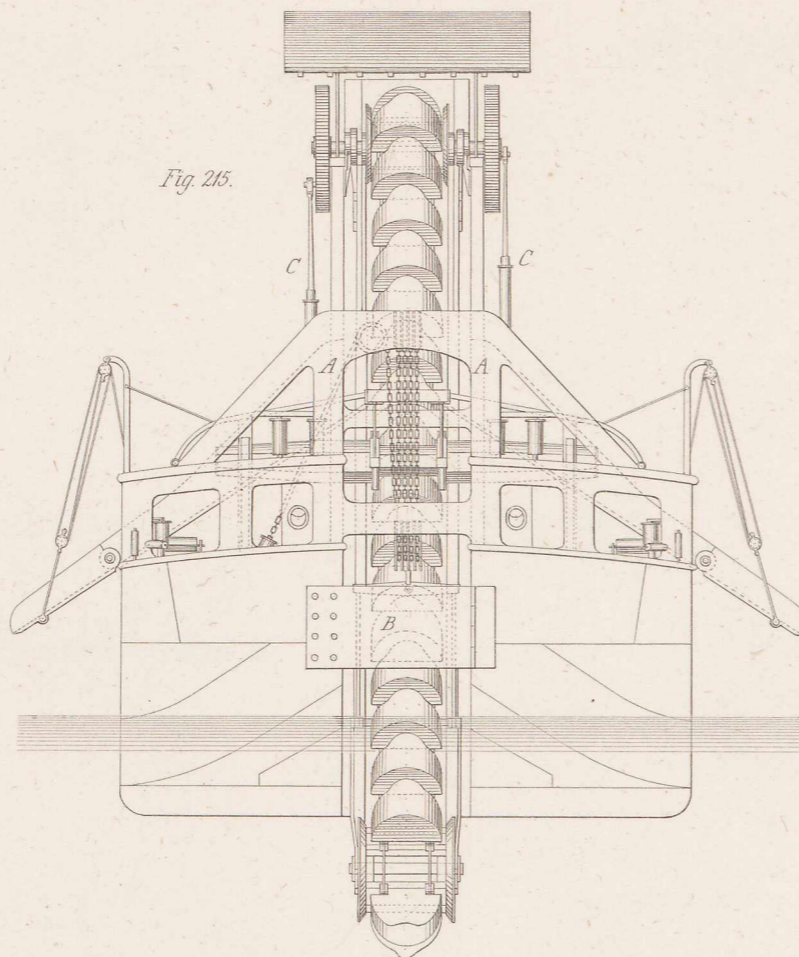

Fig. 216.

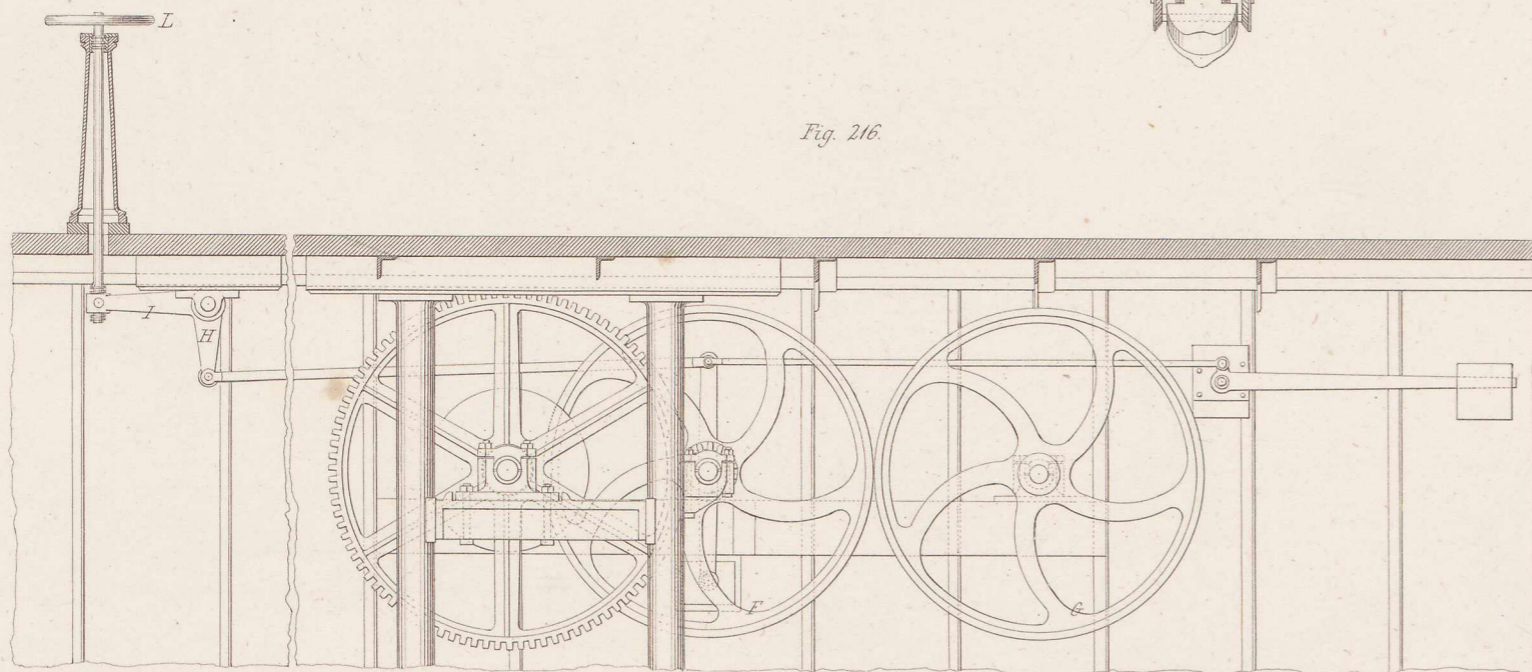
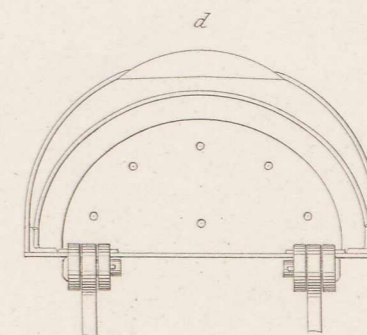
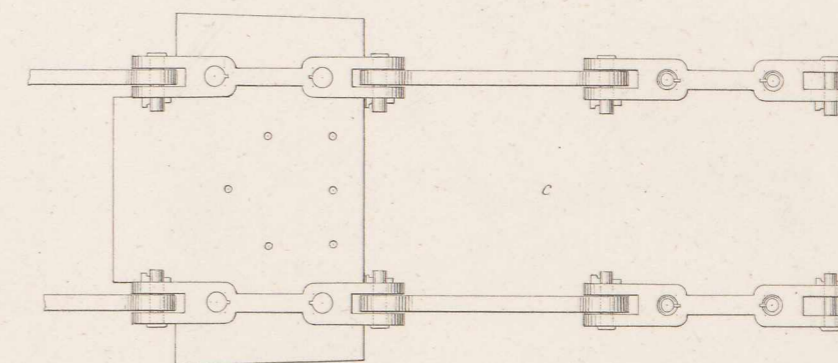
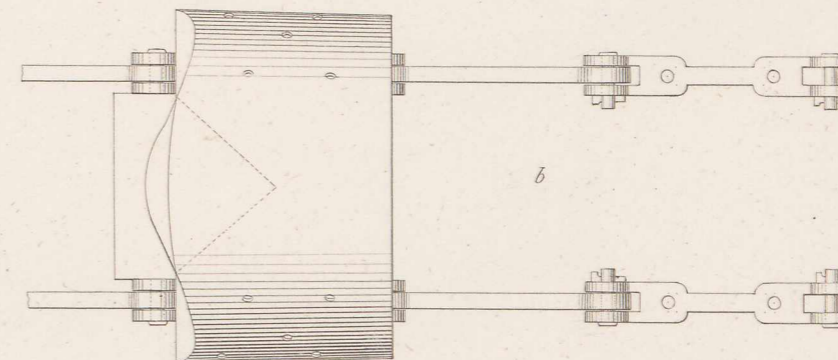
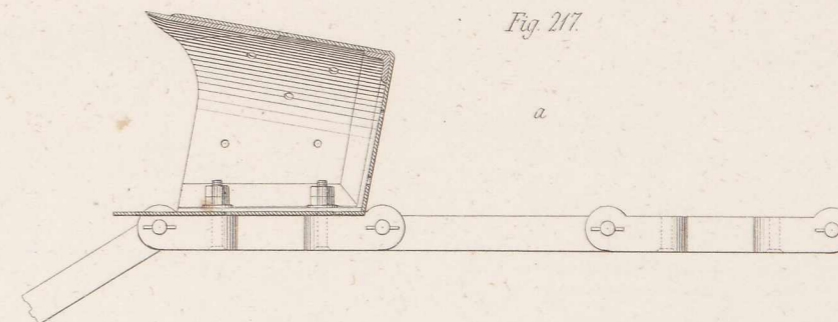

Fig. 217.



zu Fig. 214 u. 215.
 10 9 8 7 6 5 4 3 2 1 0 10 20 Fuss

zu Fig. 216.
 12 9 6 3 0 1 2 3 4 5 6 7 8 Fuss

zu Fig. 217.
 12 10 8 6 4 2 0 1 2 3 4 5 Fuss

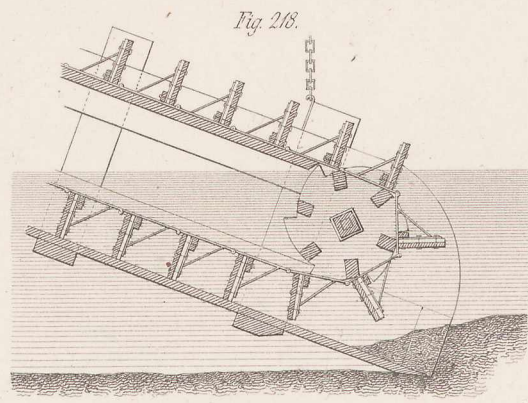

Fig. 218.

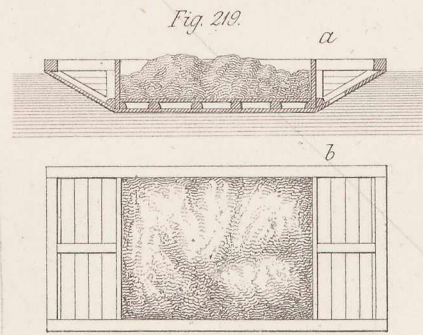

Fig. 219.

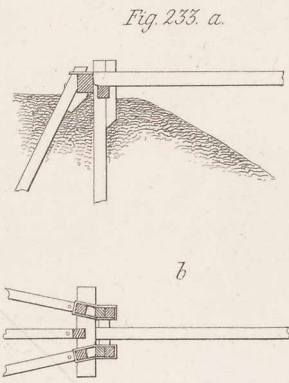

Fig. 233. a.



Fig. 220.

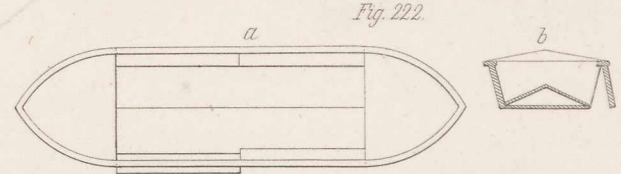

Fig. 222.

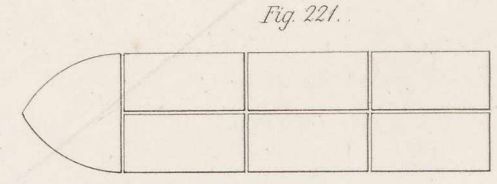

Fig. 221.

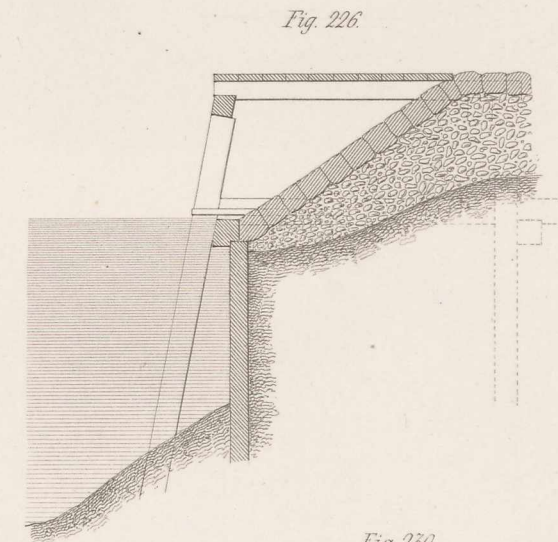

Fig. 226.

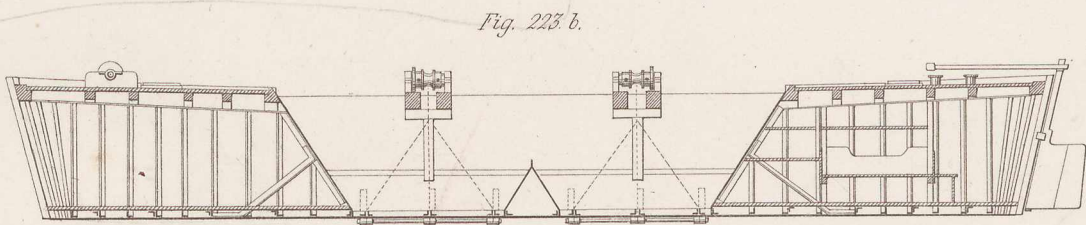

Fig. 223. b.

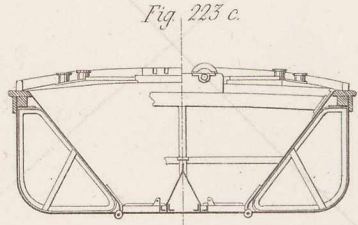

Fig. 223. a.

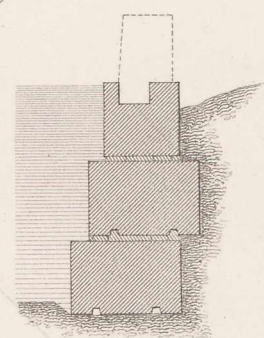
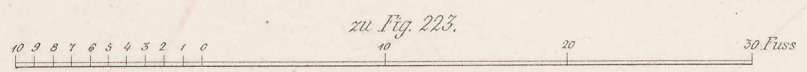

Fig. 228.



zu Fig. 223.

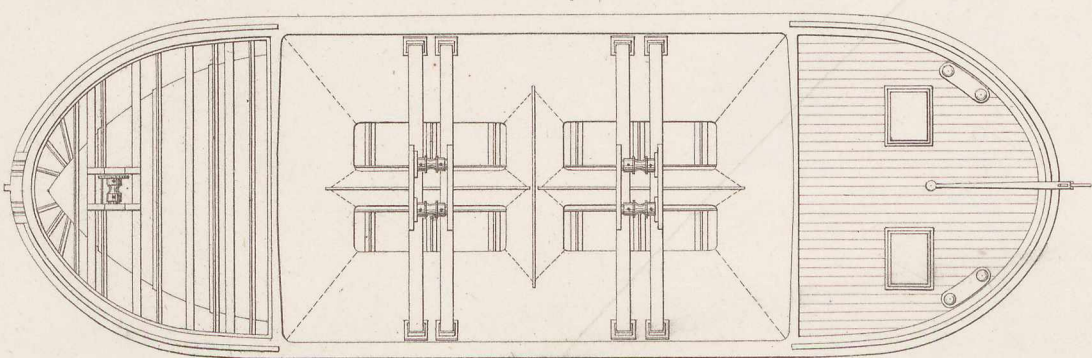

Fig. 225. a.

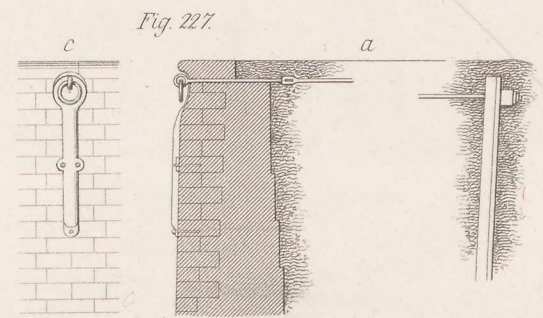

Fig. 227.

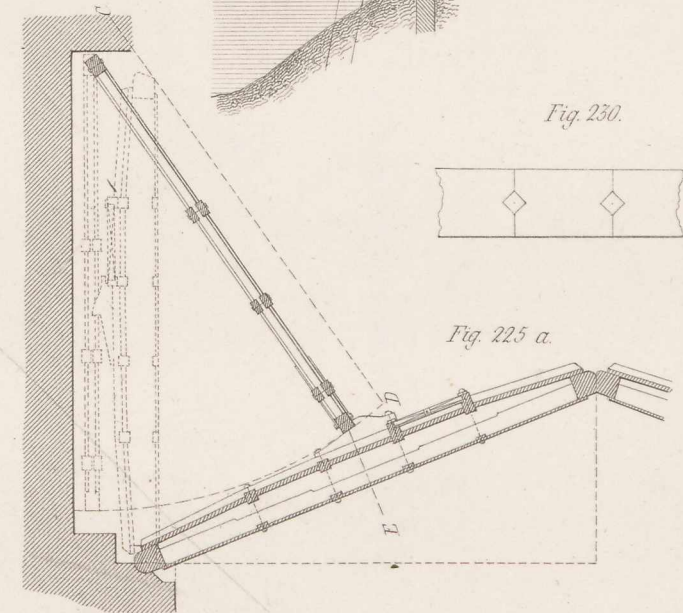

Fig. 225. a.

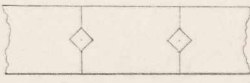

Fig. 230.

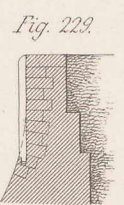

Fig. 229.

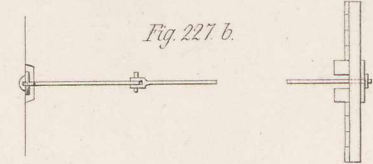

Fig. 227. b.

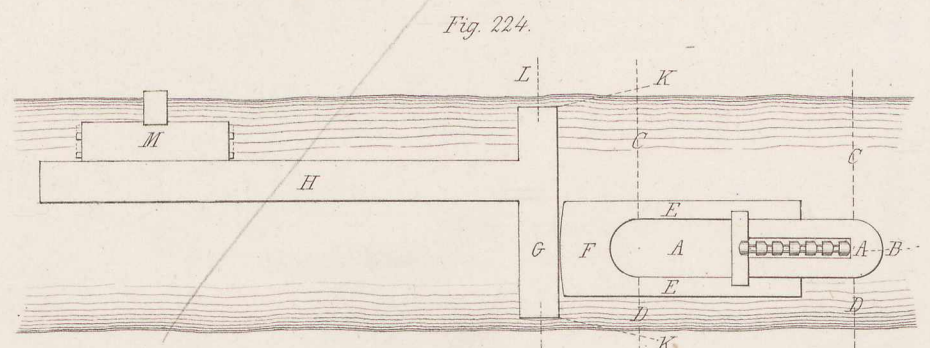

Fig. 224.

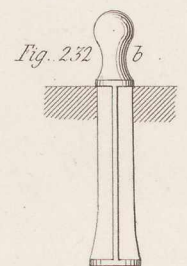

Fig. 232. a.

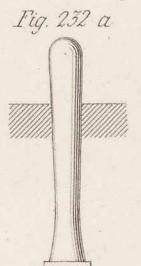

Fig. 232. b.

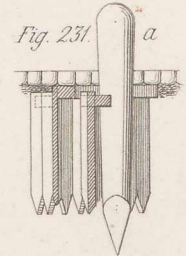
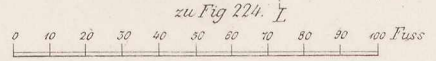
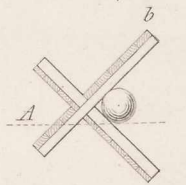

Fig. 231.



zu Fig. 224.

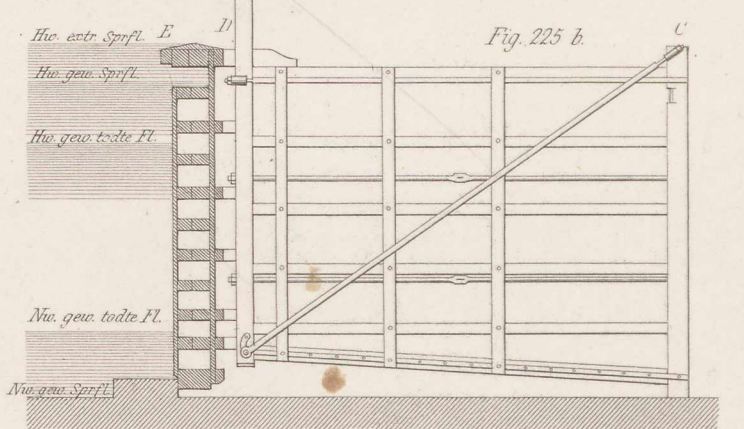
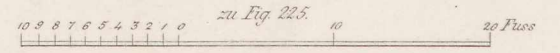
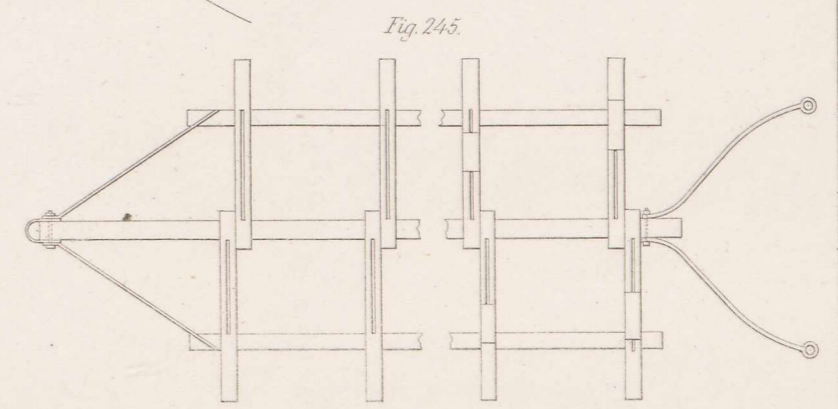
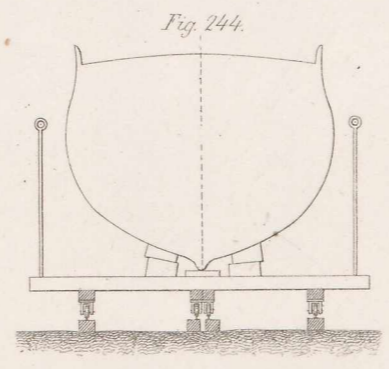
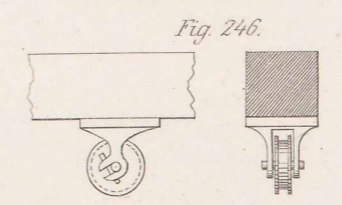
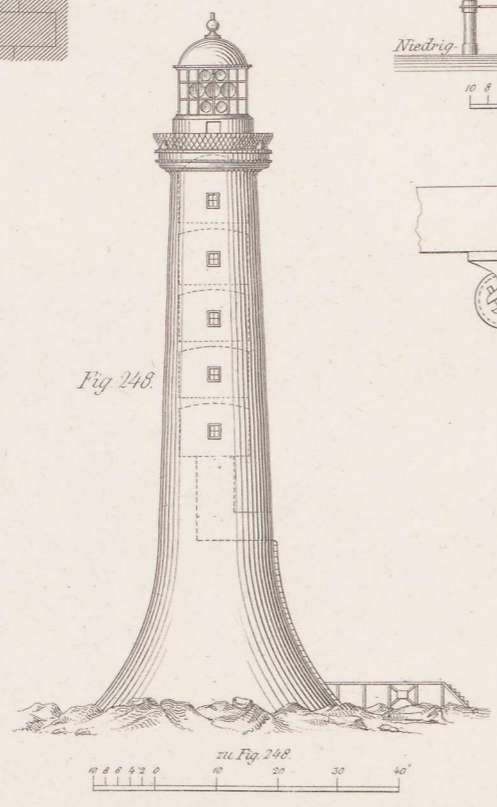
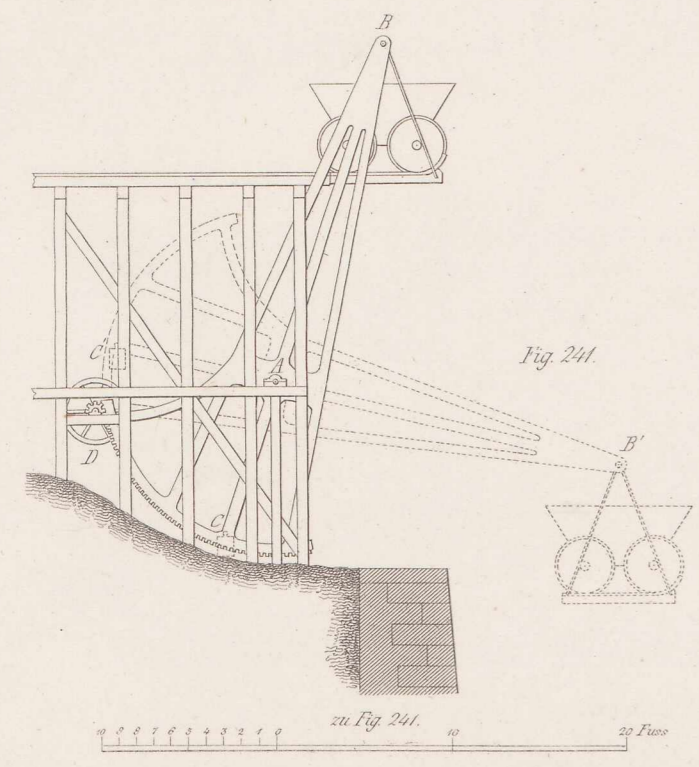
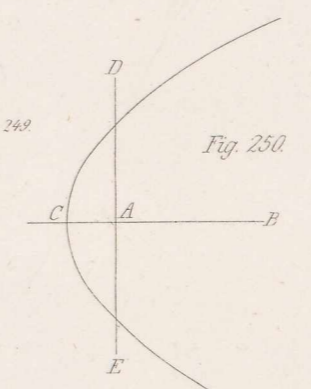
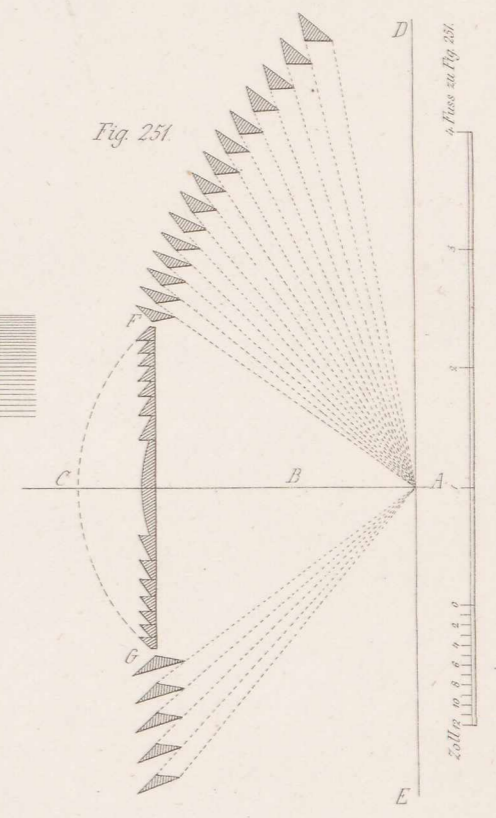
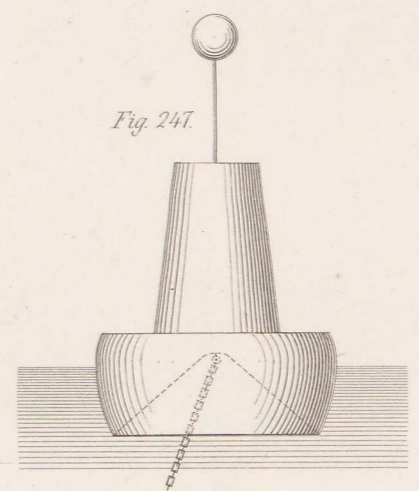
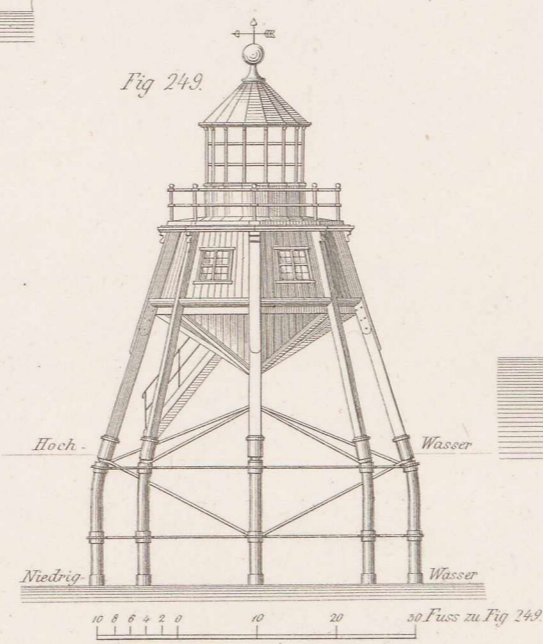
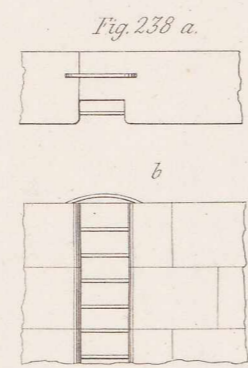
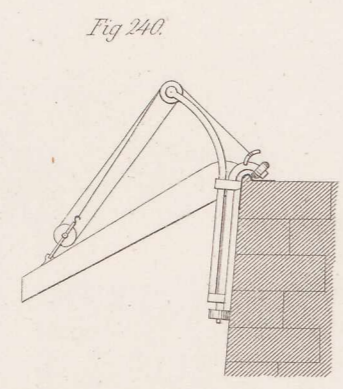
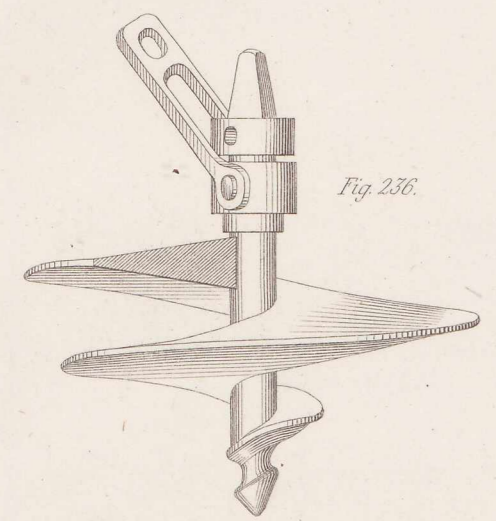
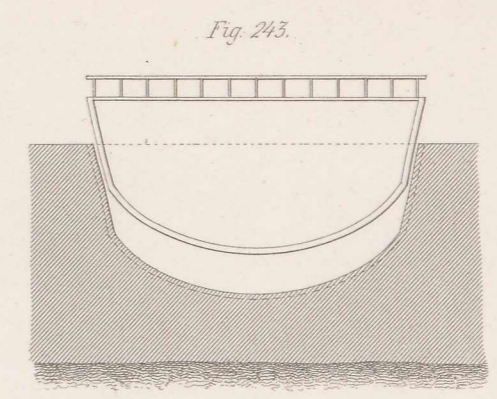
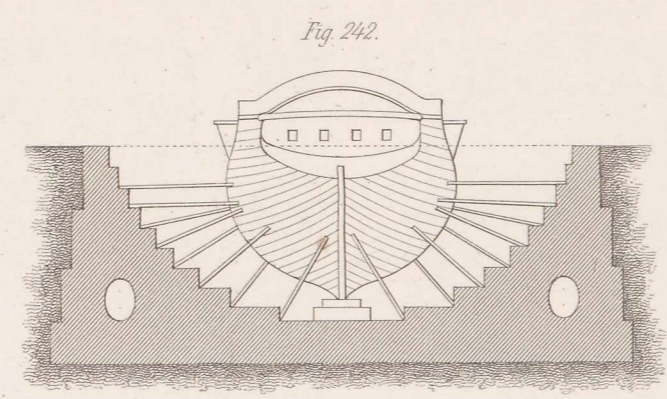
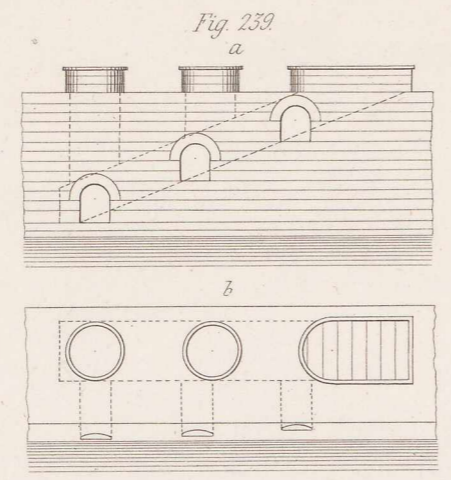
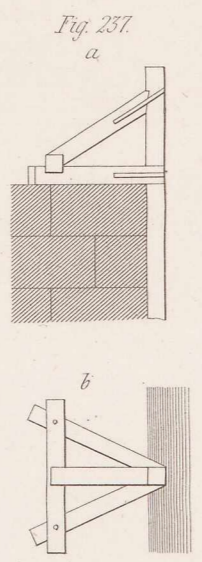
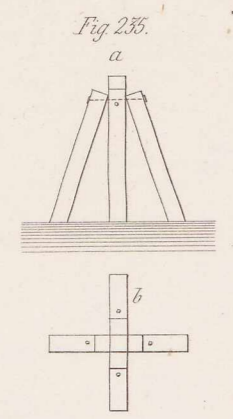
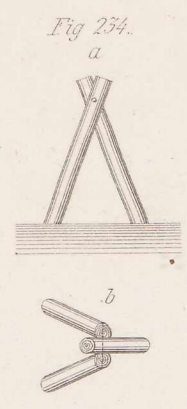
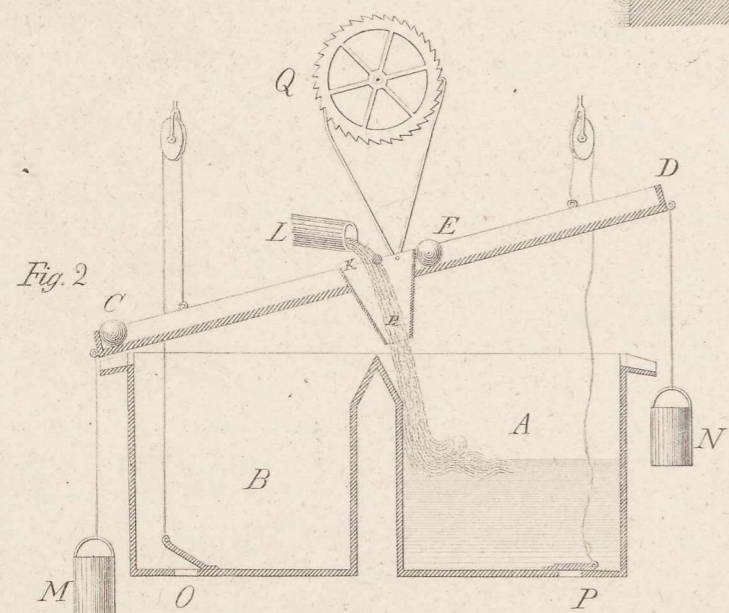
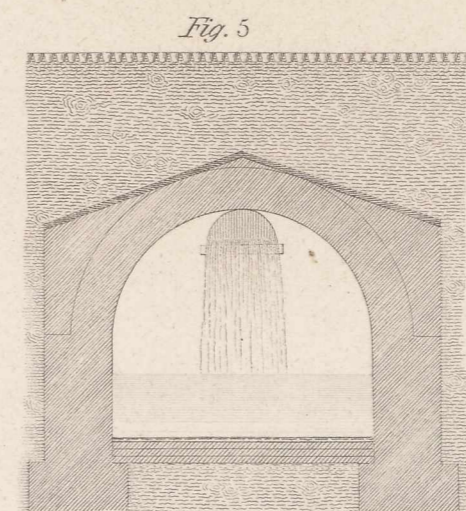
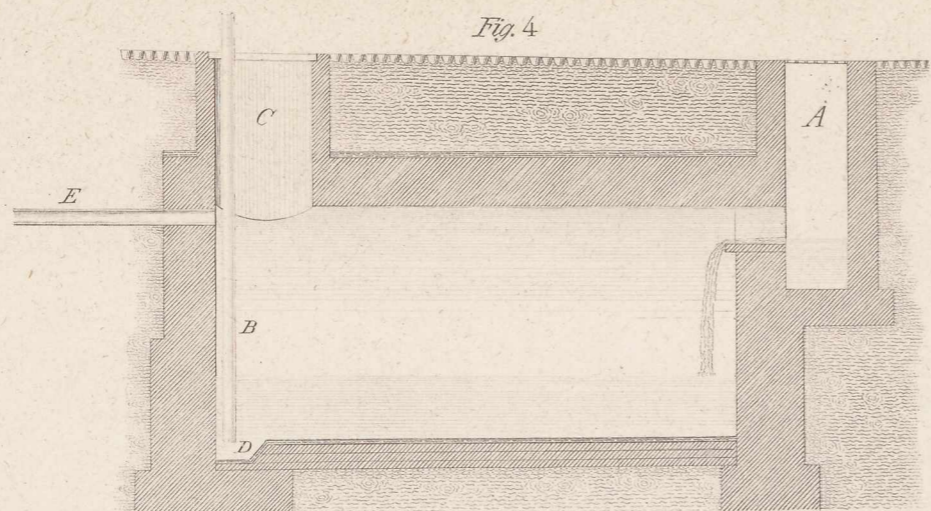
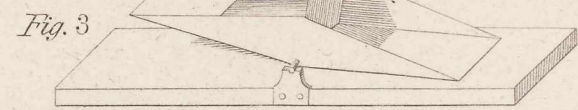

Fig. 225. b.



zu Fig. 225.





10 5 0 10 Fuss
zu Fig. 4, 5 und 9

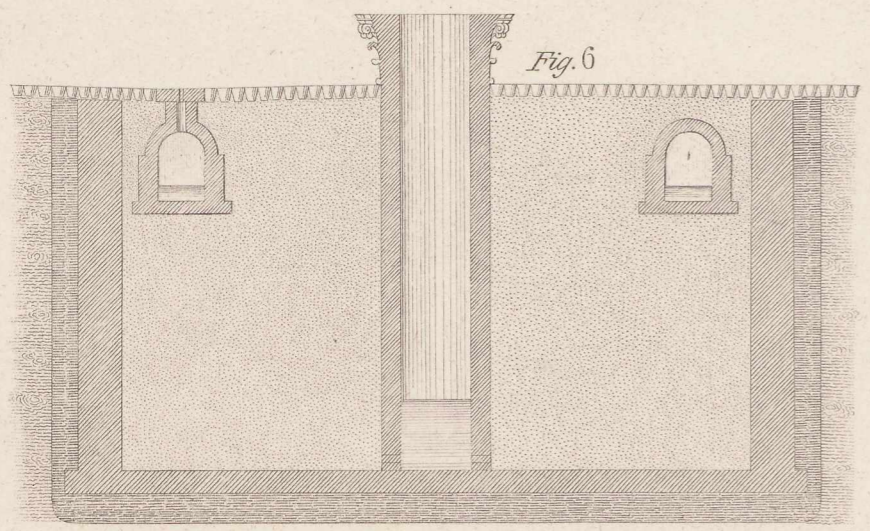
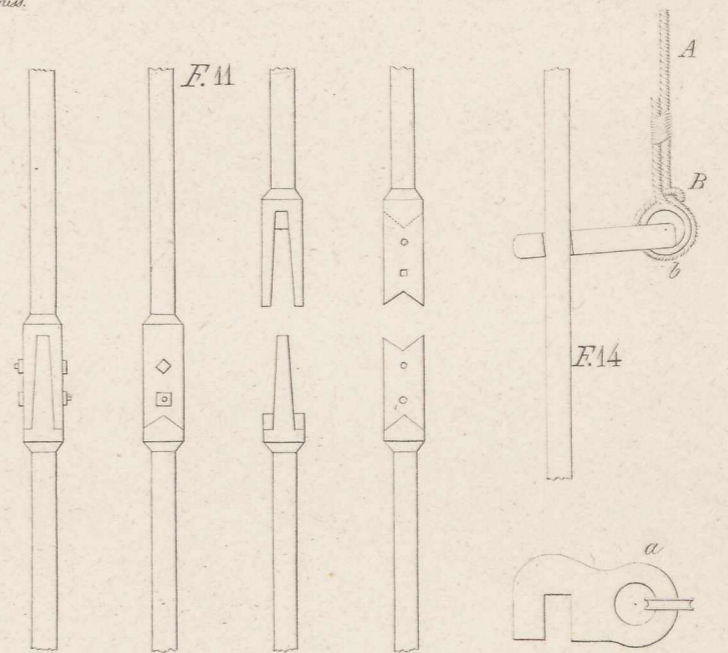
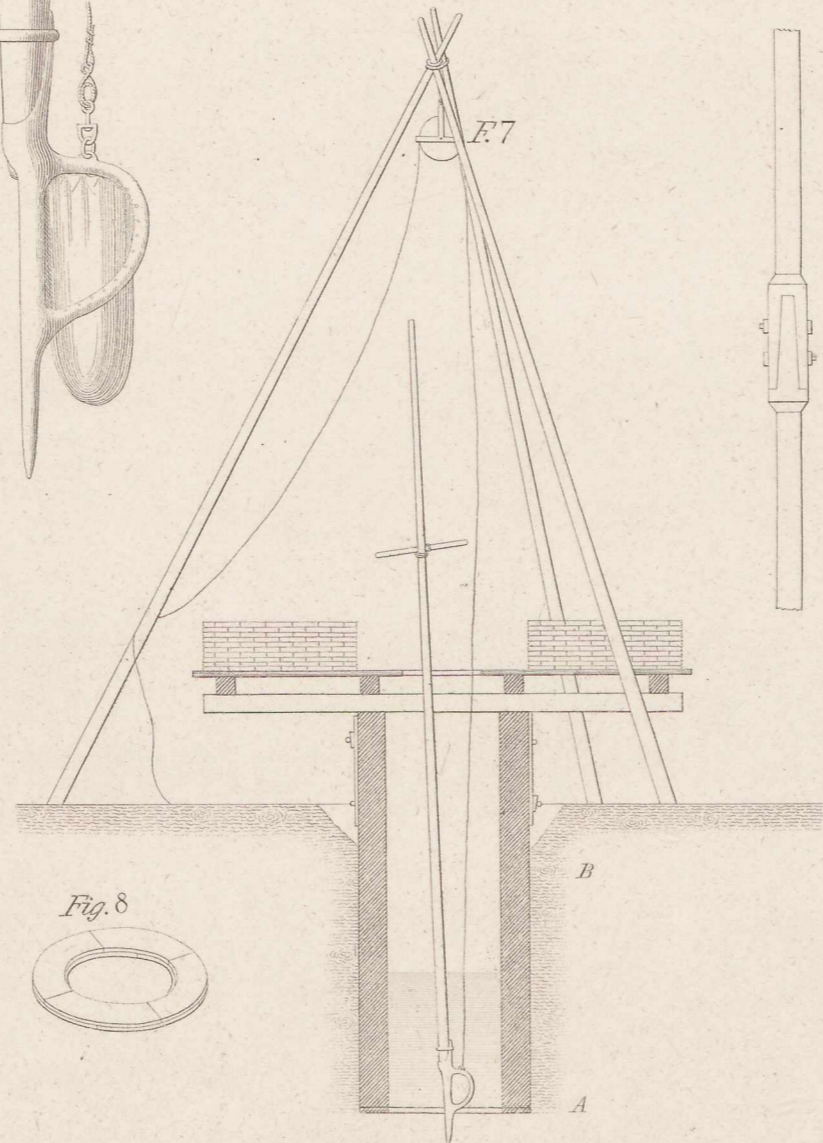
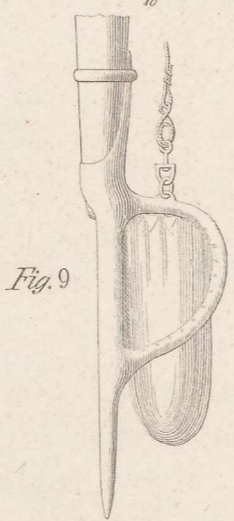

10 5 0 10 20 Fuss

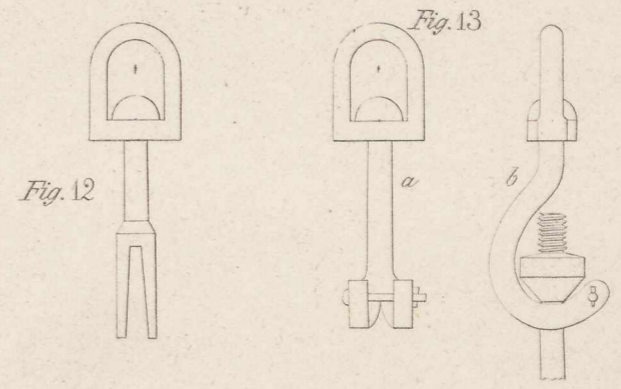
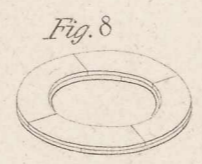

12 9 6 3 0 12 Zoll.
zu Fig. 10, 11, 12, 13 und 14

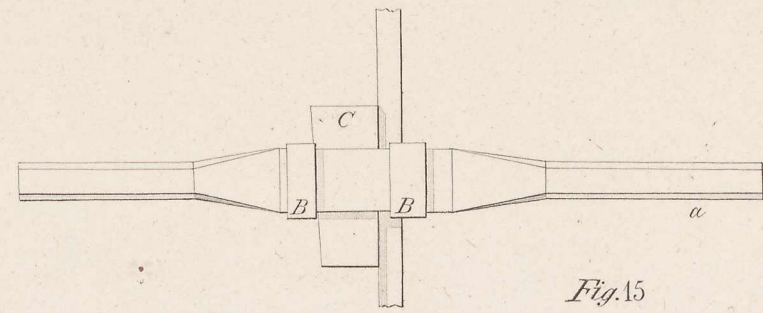

Fig. 15

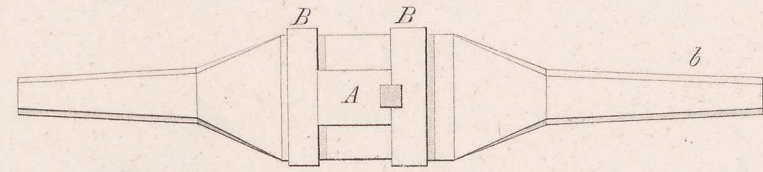

Fig. 16

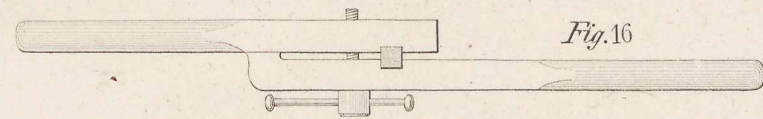

Fig. 17

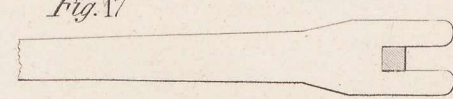
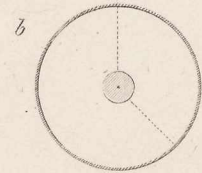

Fig. 18



b

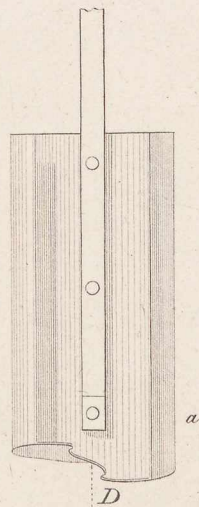
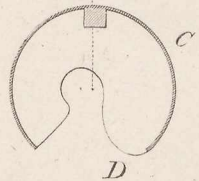
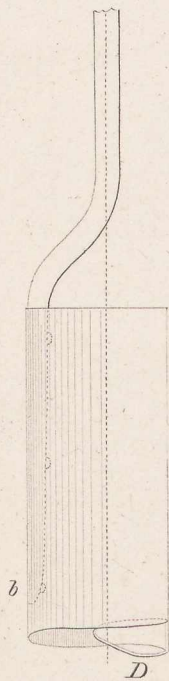

Fig. 19



D



b

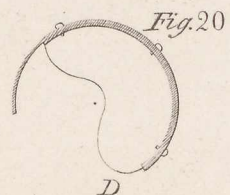

D

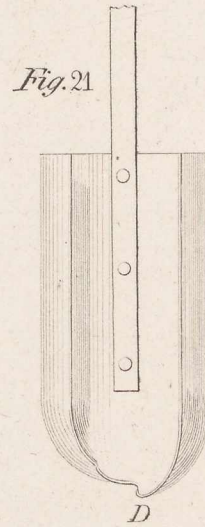

Fig. 21

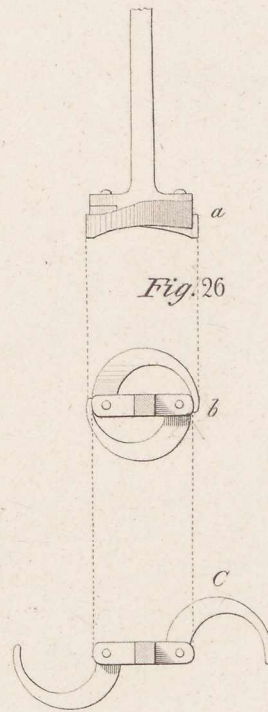

Fig. 22

c

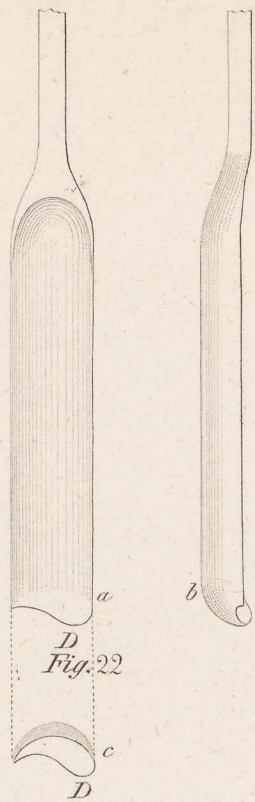

Fig. 23

D

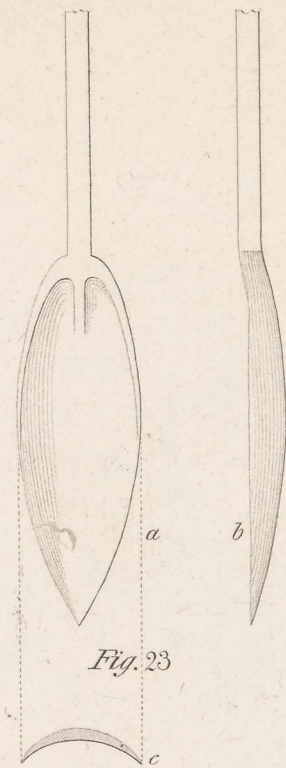

Fig. 24

c

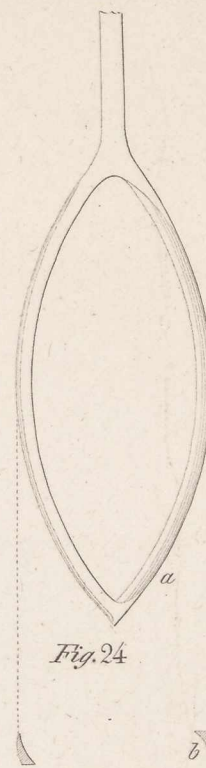

Fig. 25

b

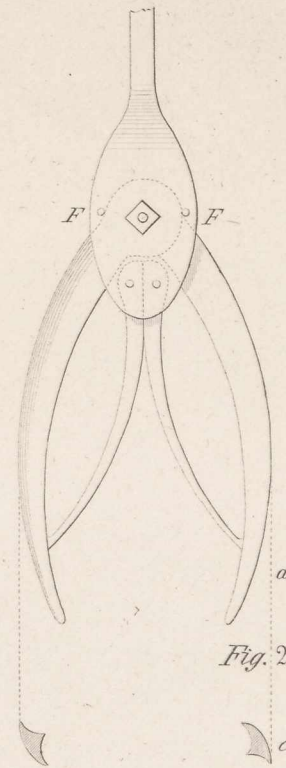
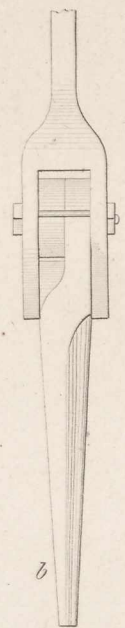

Fig. 26

c



b

Fig. 30

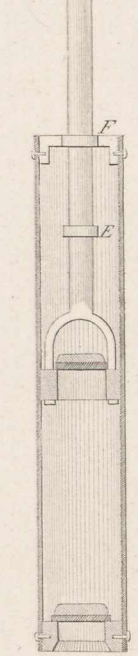

Fig. 27

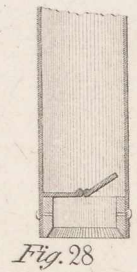

Fig. 28

Fig. 29

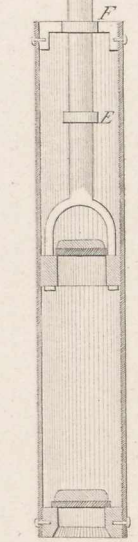
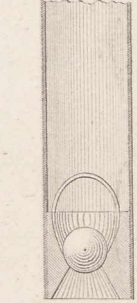
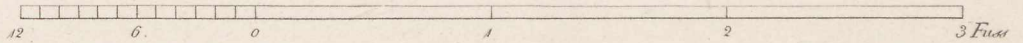
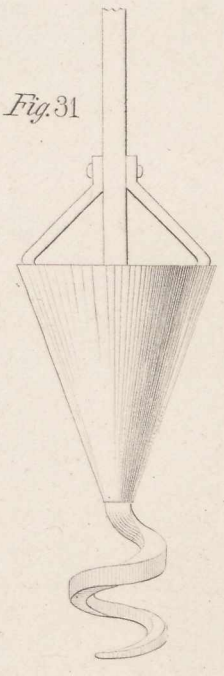
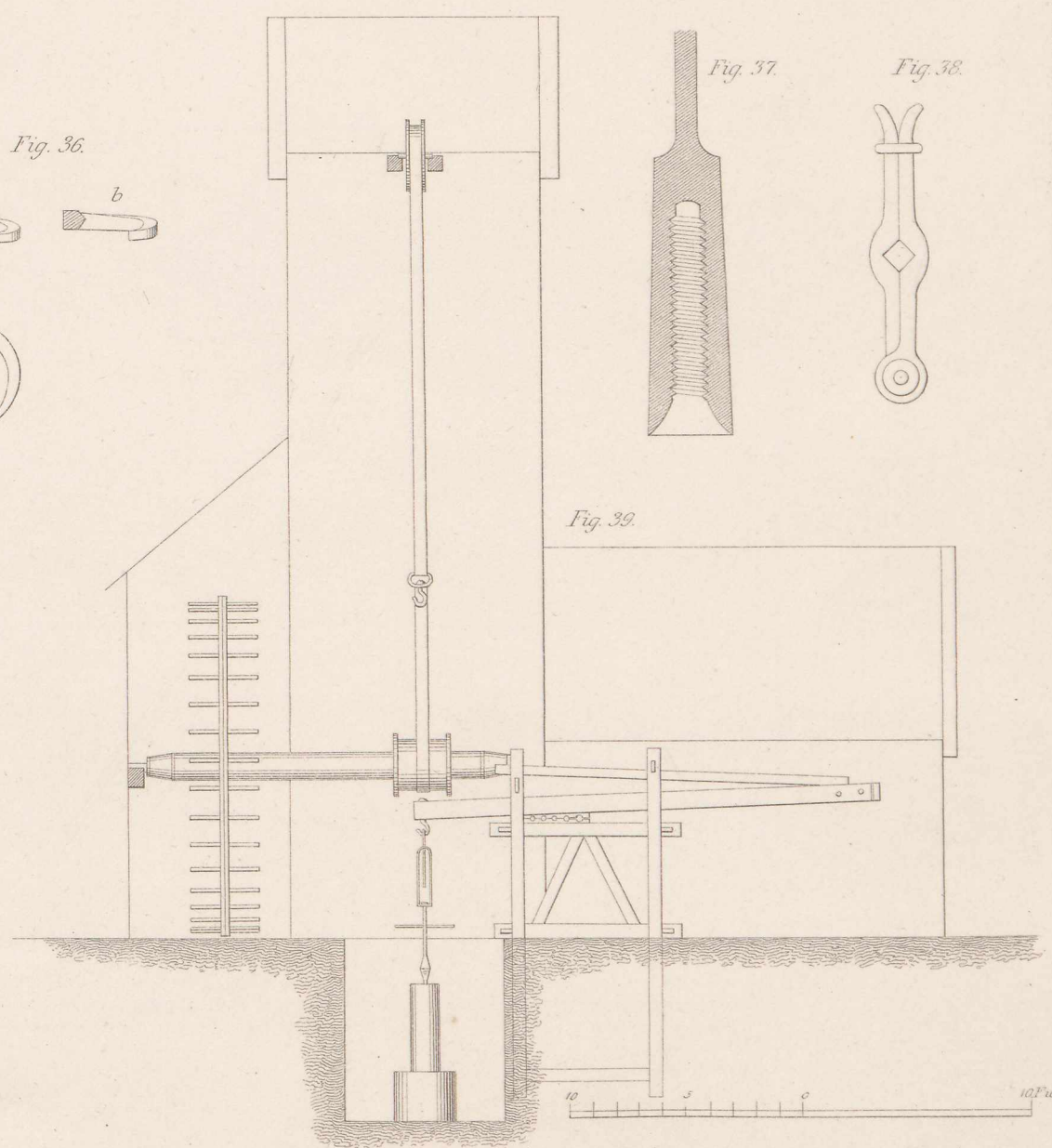
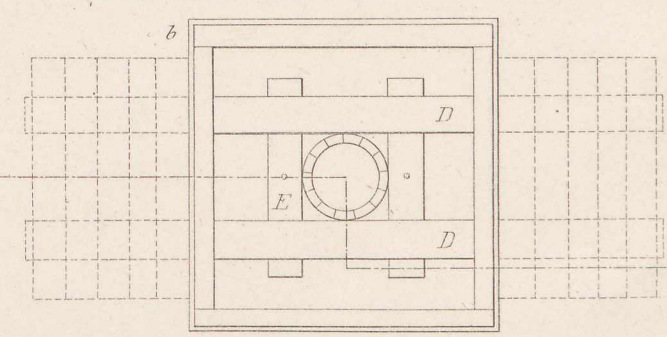
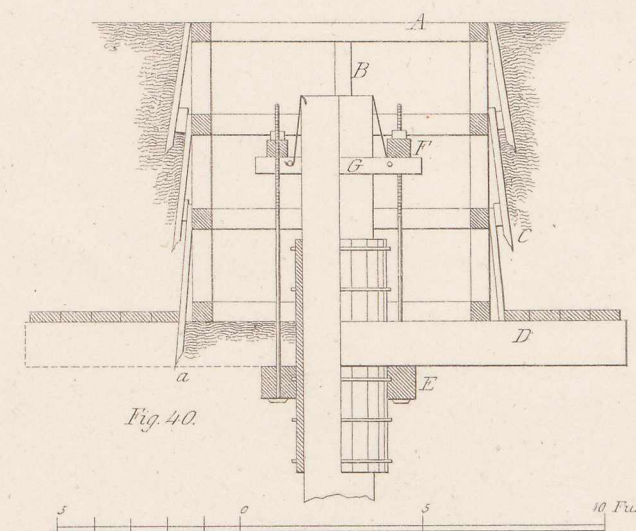
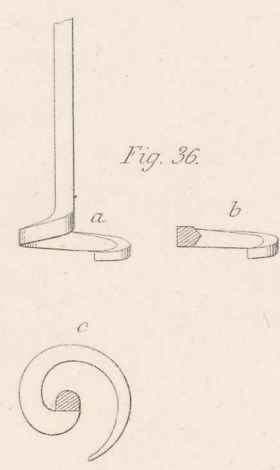
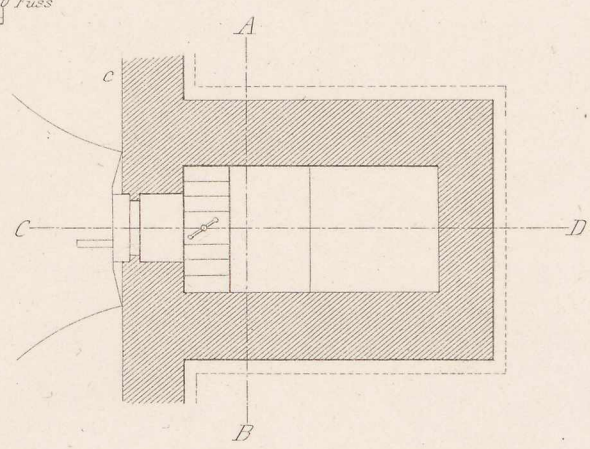
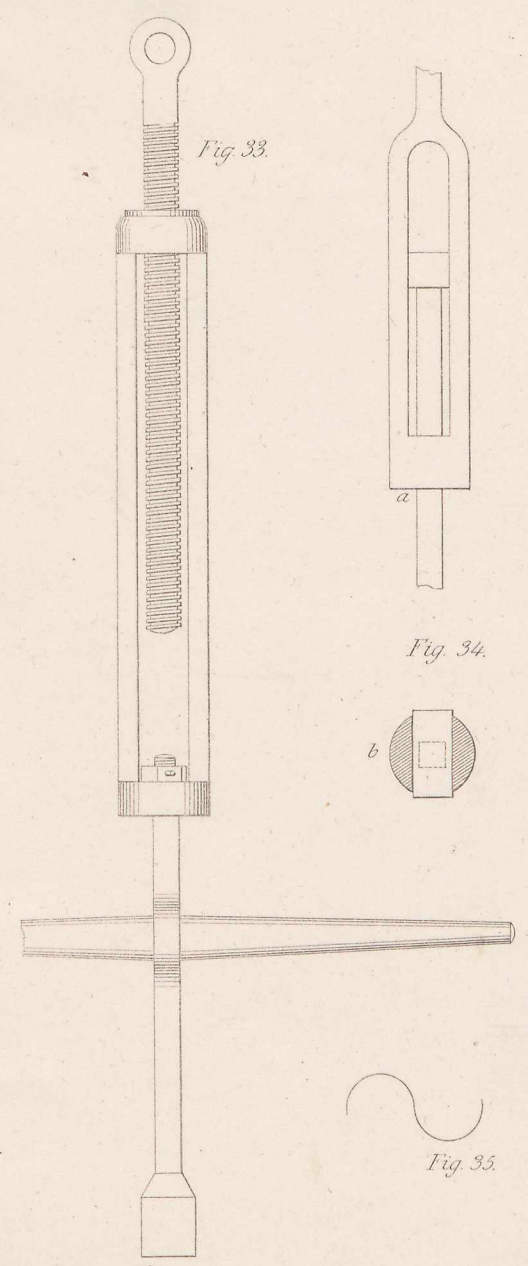
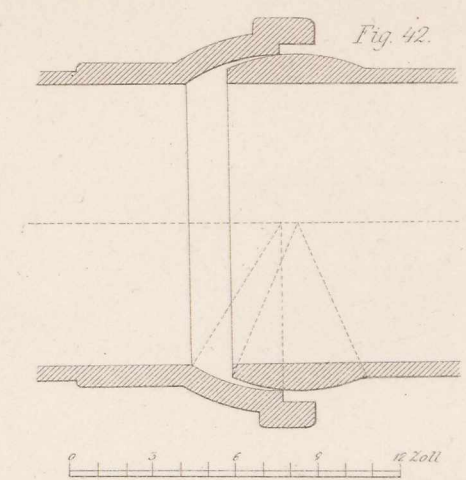
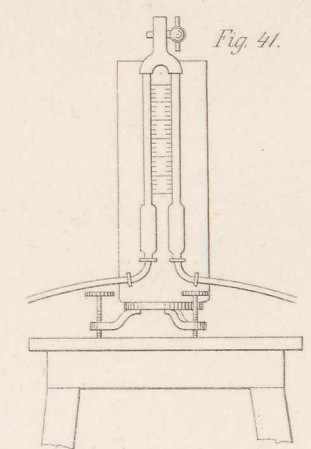
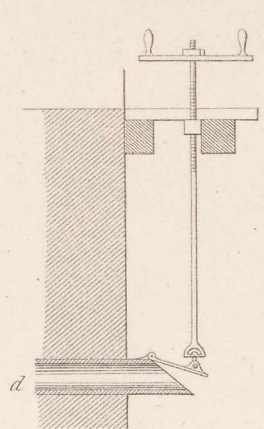
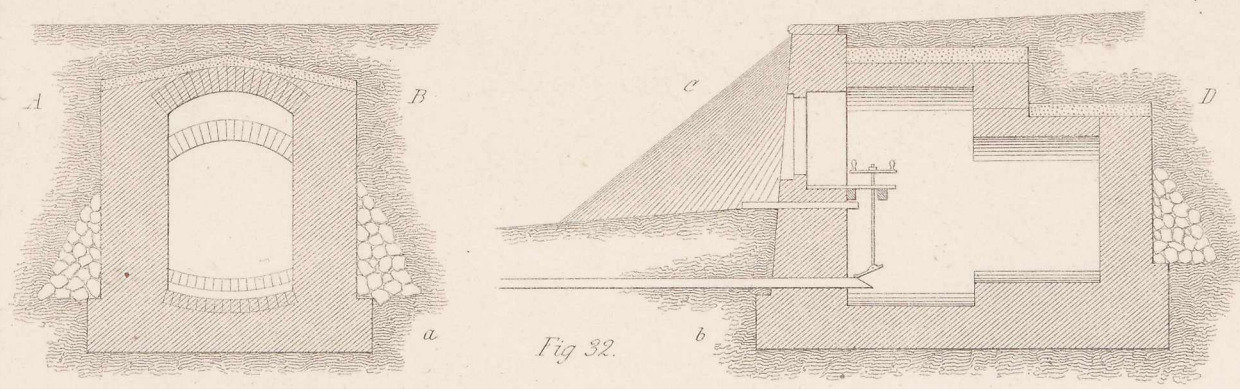

Fig. 31





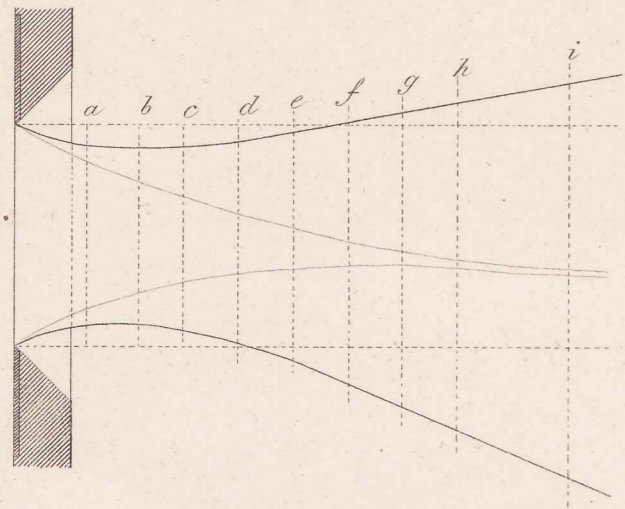

Fig. 69

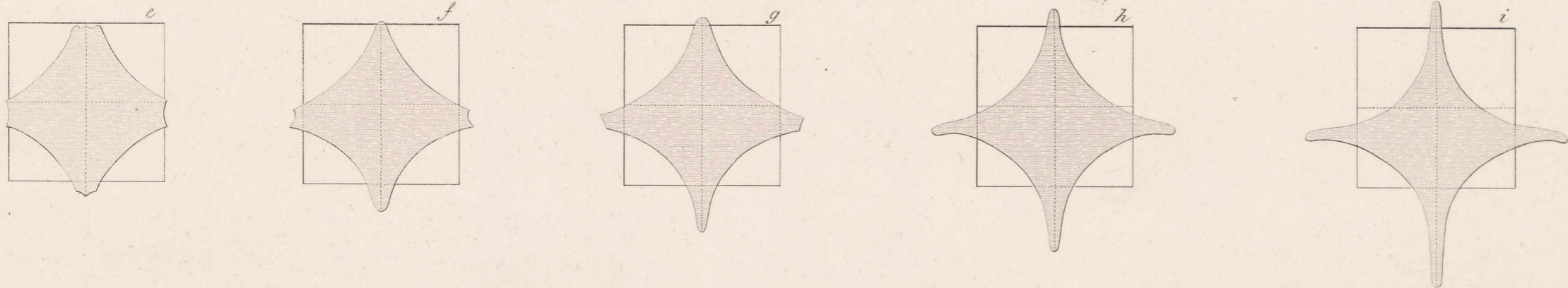
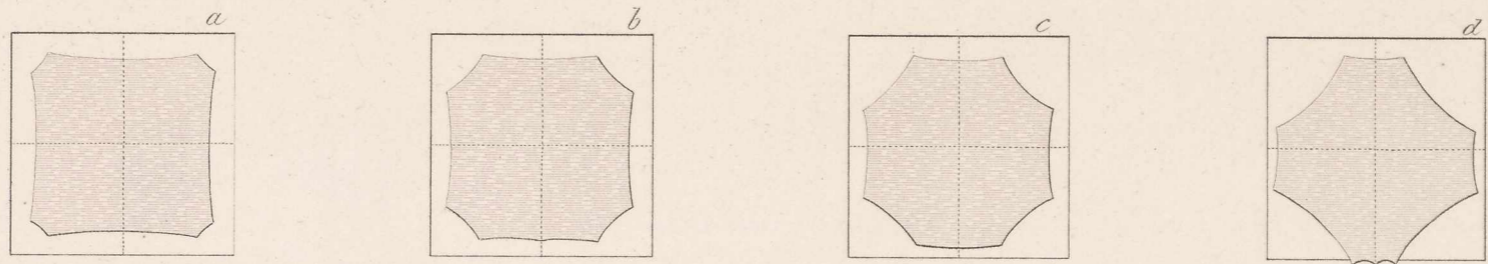
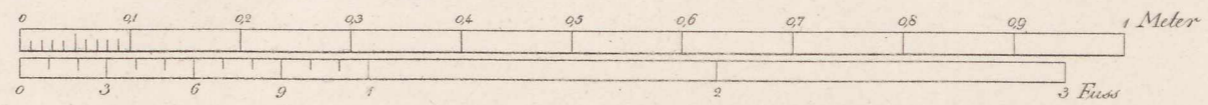
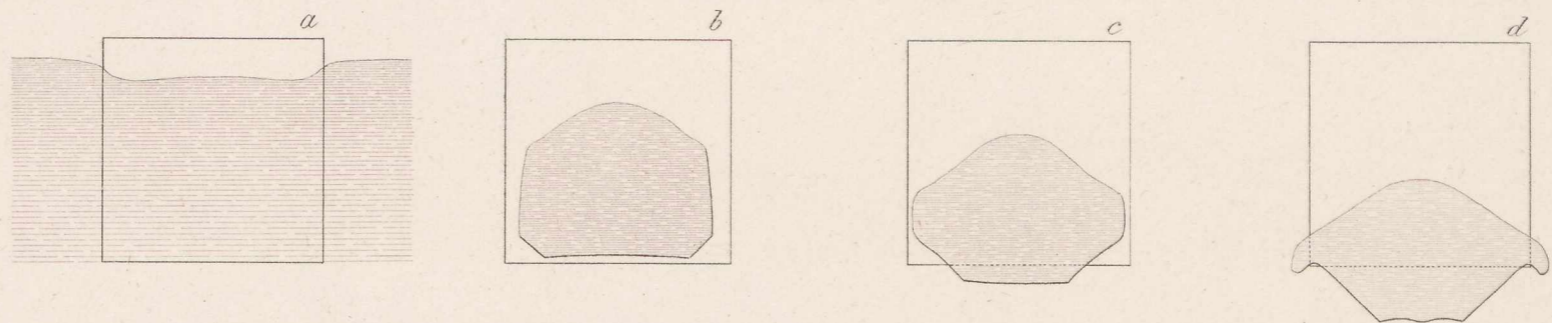
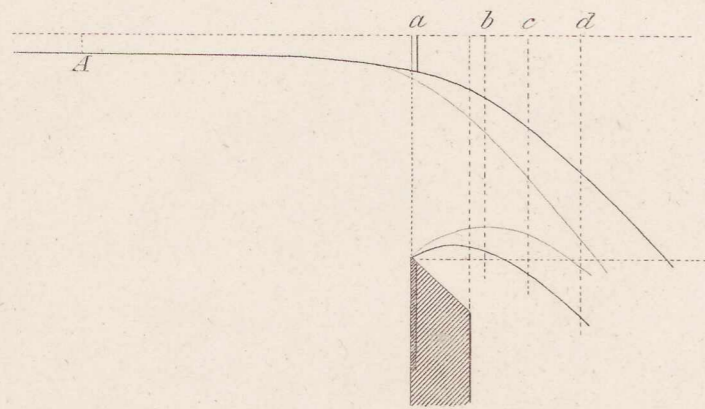
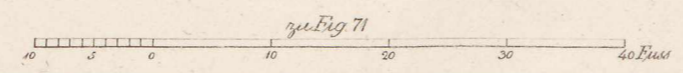
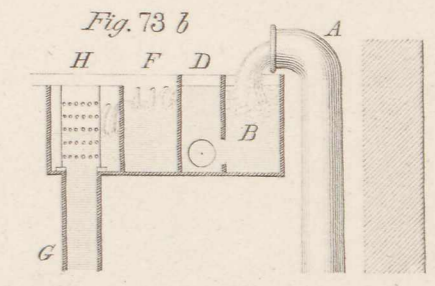
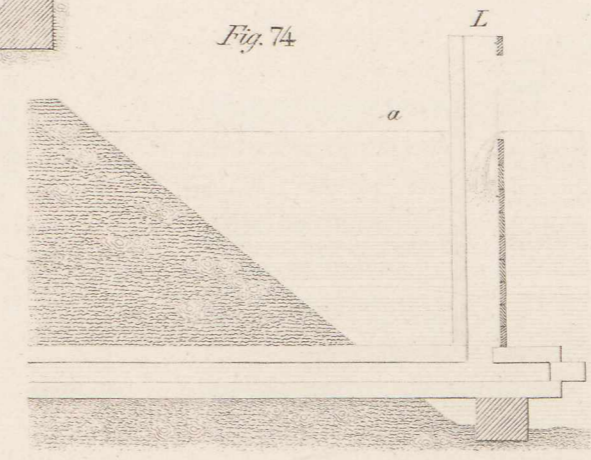
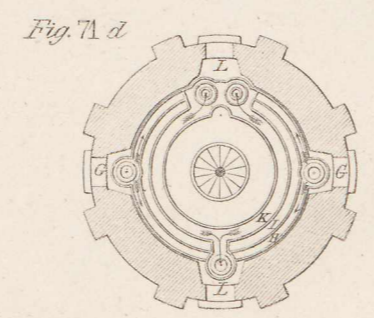
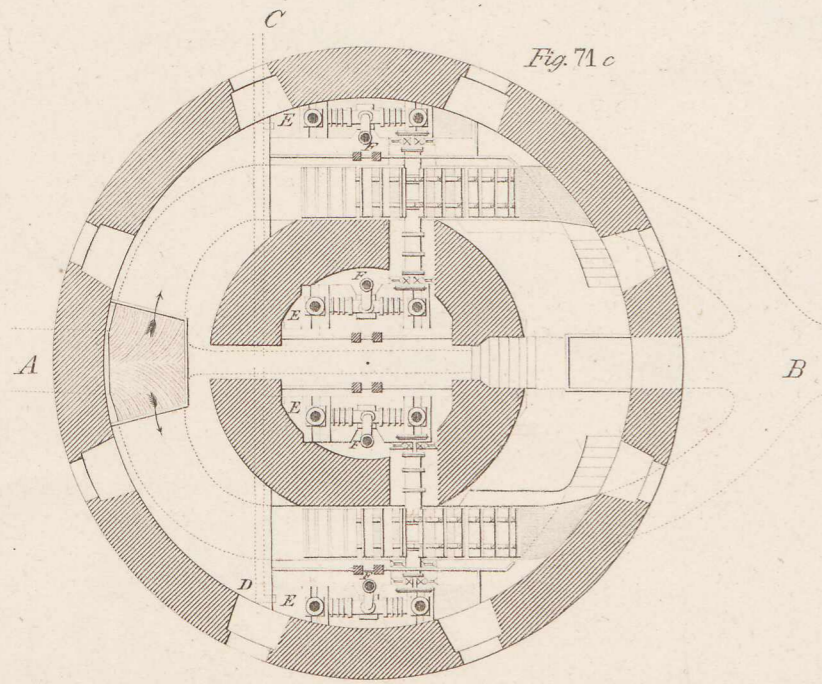
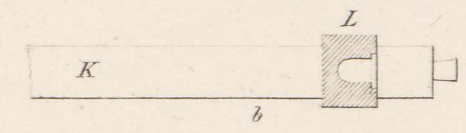
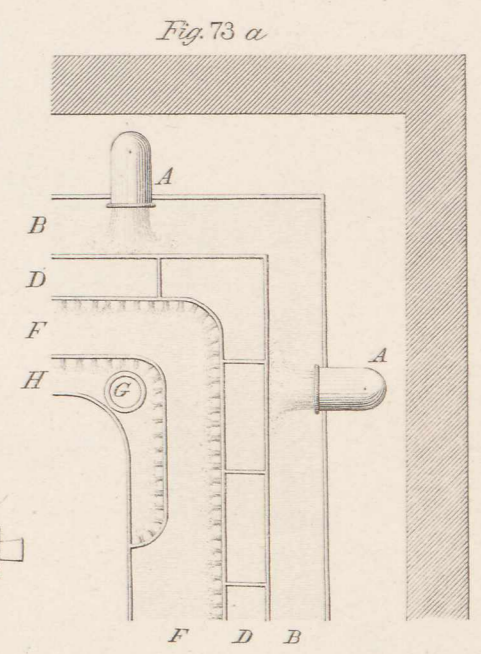
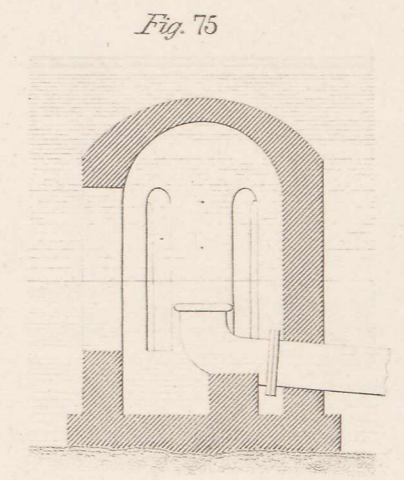
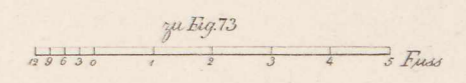
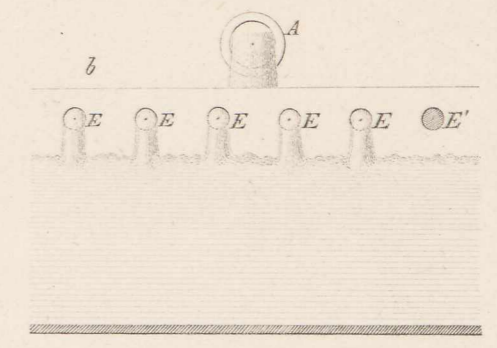
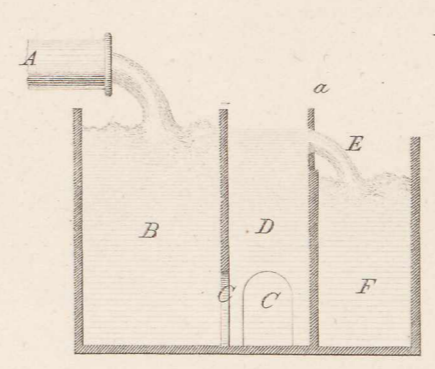
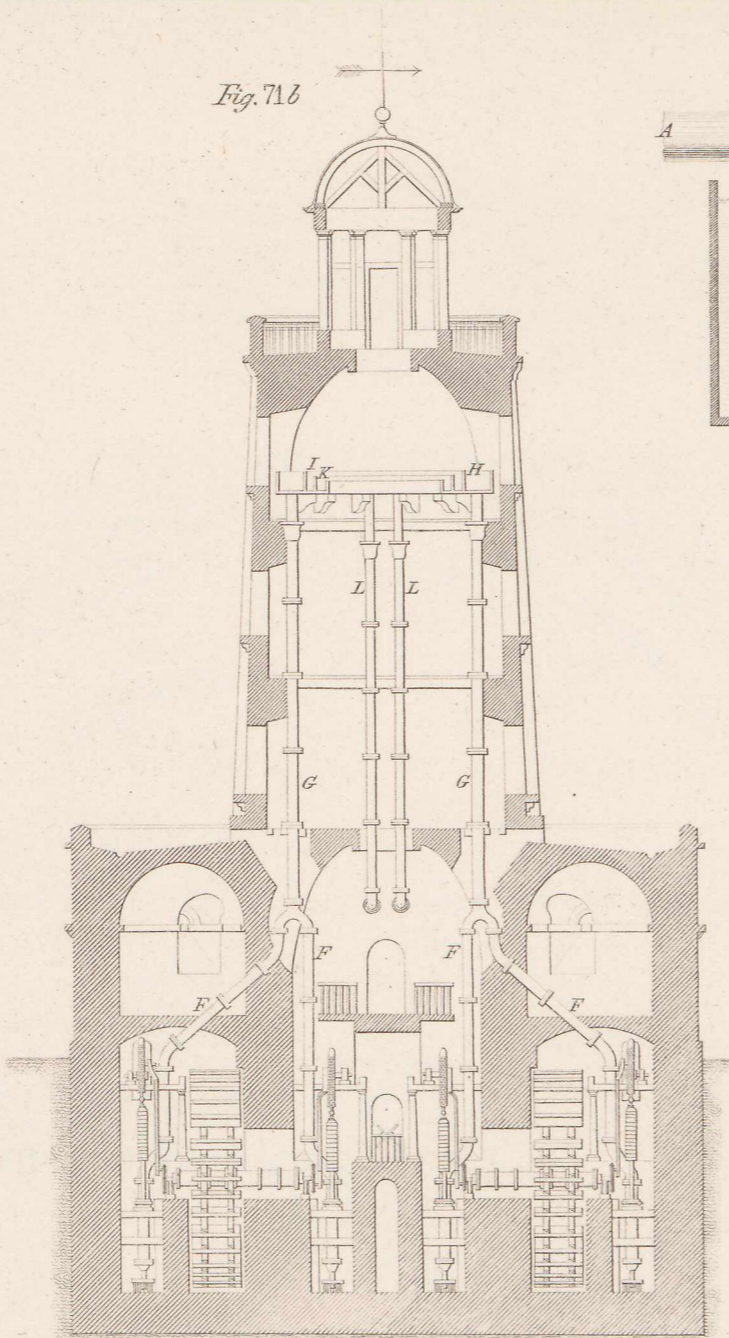
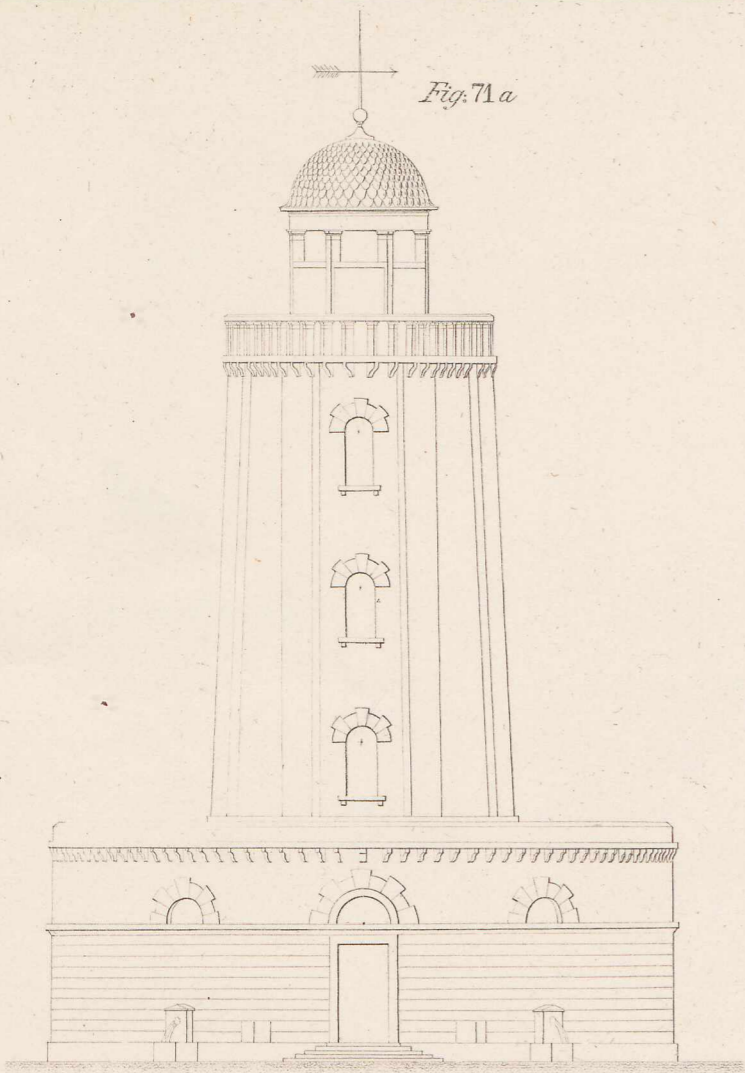
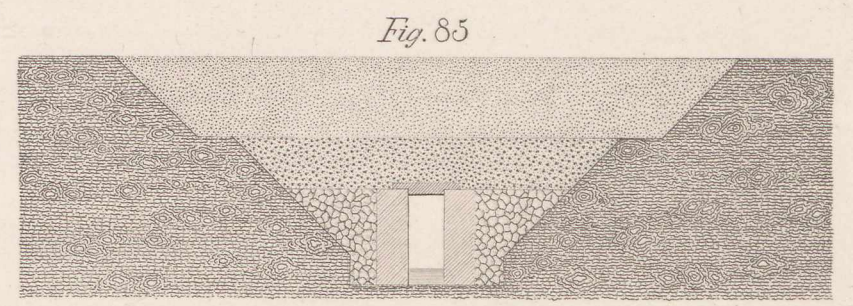
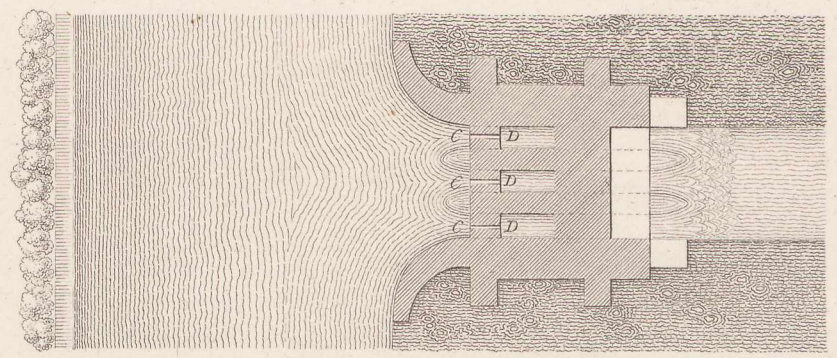
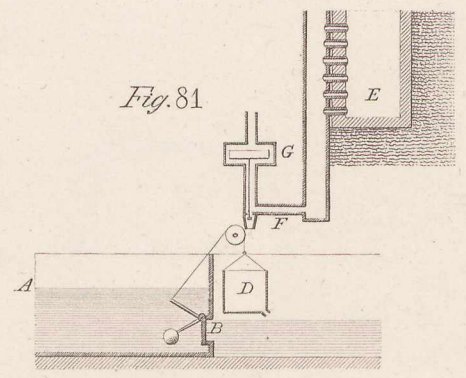
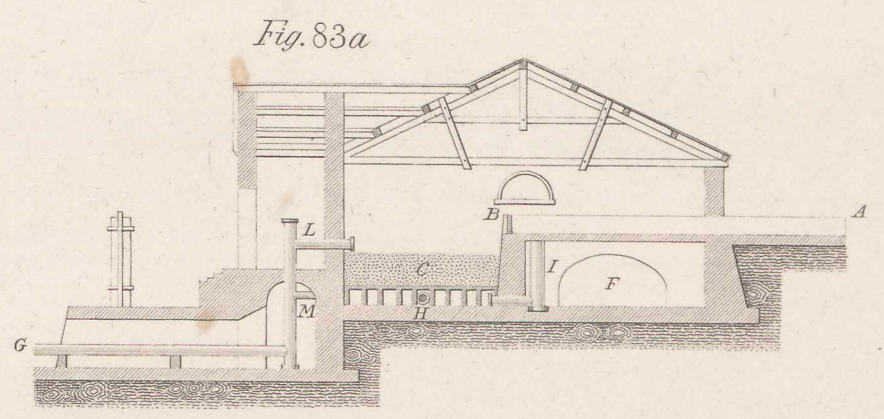
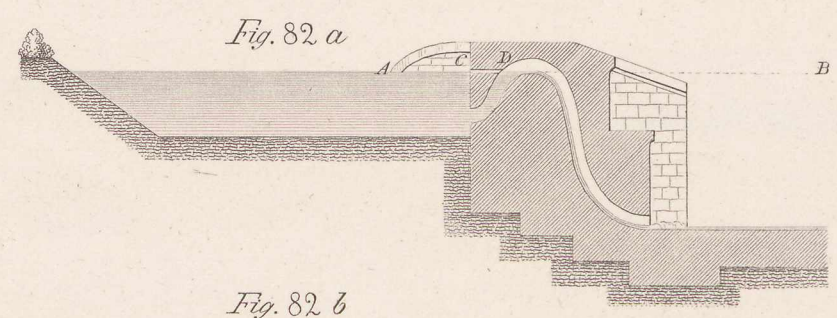
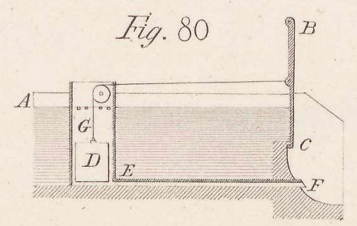
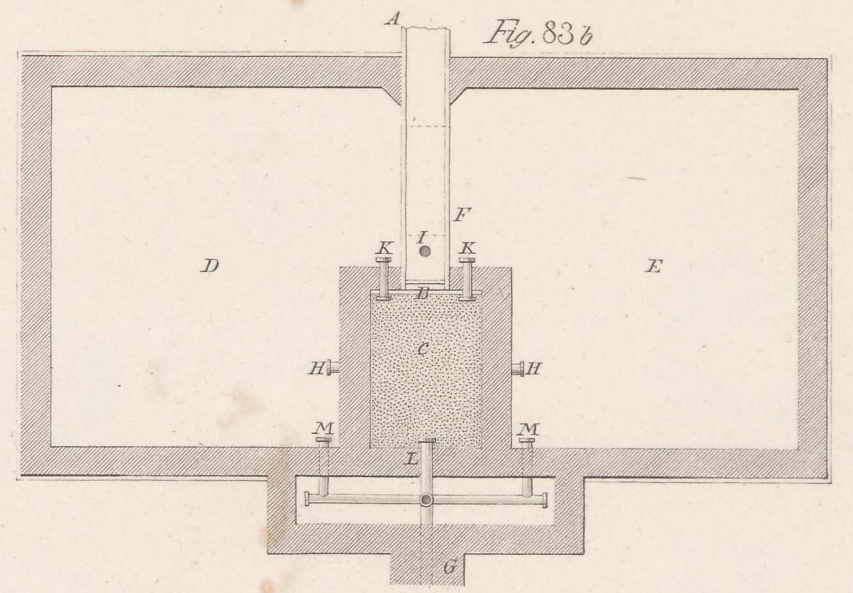
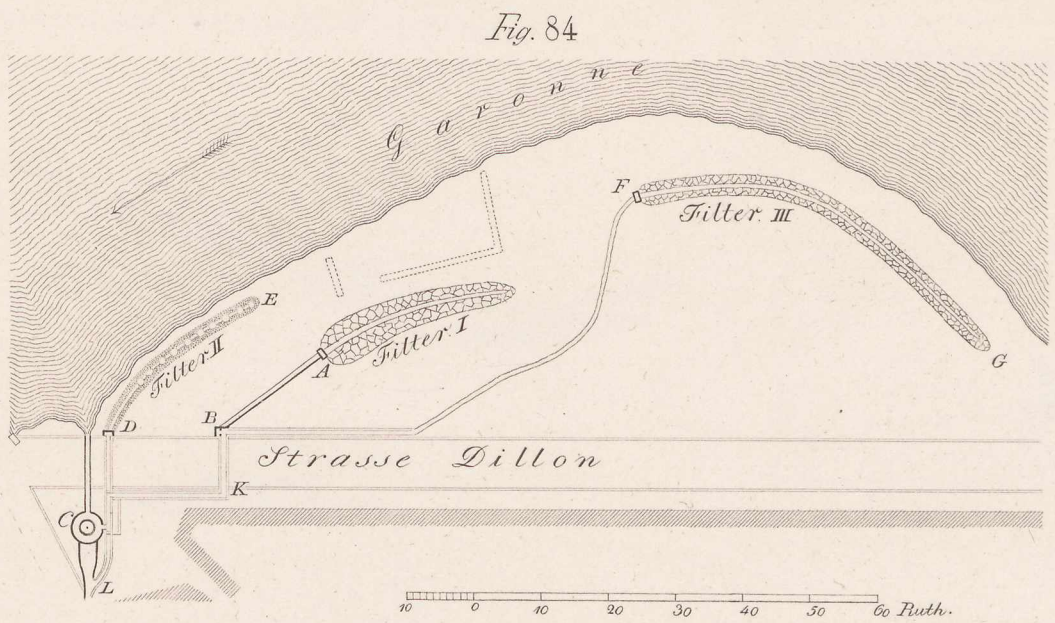
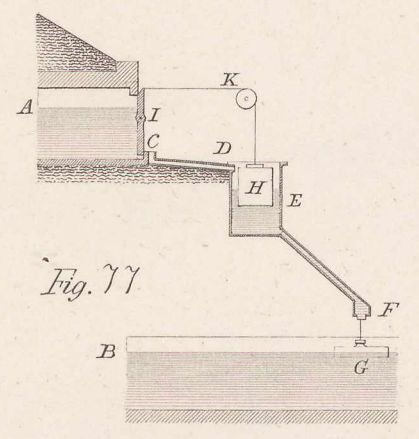
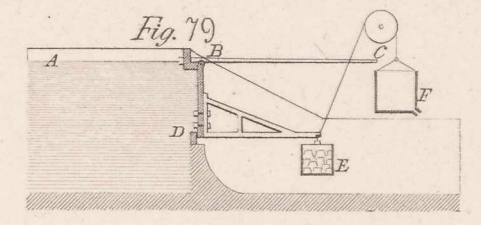
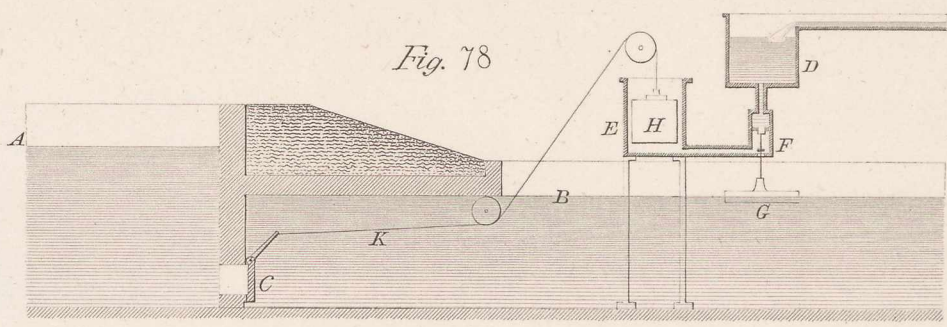
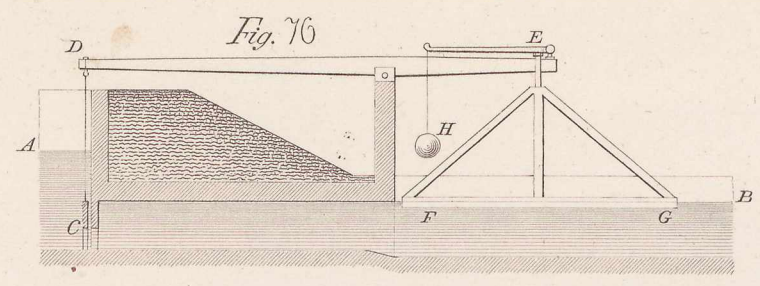

Fig. 70







zu Fig. 82 u. 83
 Fig. 85.
 10 0 10 20 30 40 50 Fufs
 10 5 0 10 Fufs

Fig. 86.

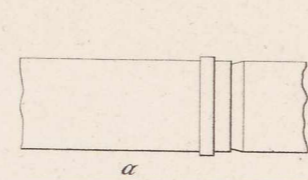
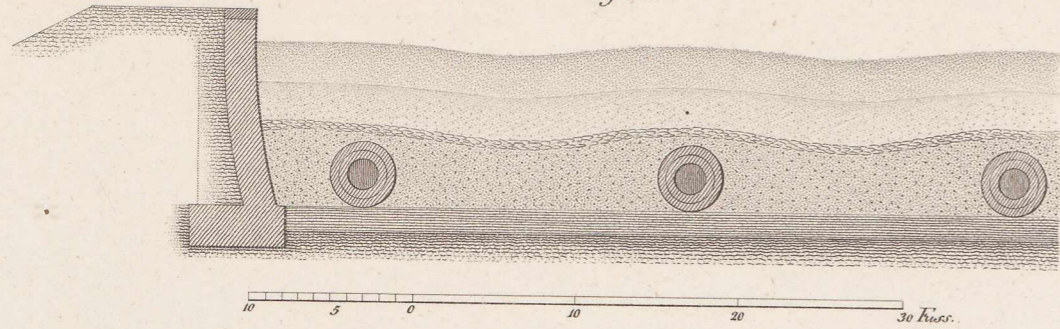

Fig. 88.

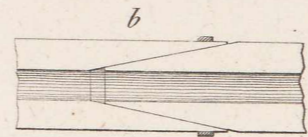

Fig. 90.

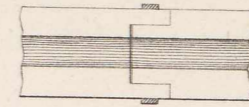

Fig. 89.

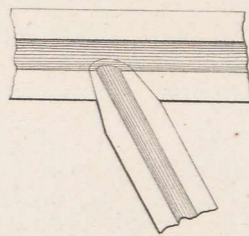

Fig. 93 a.

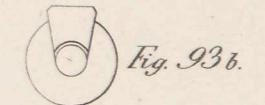
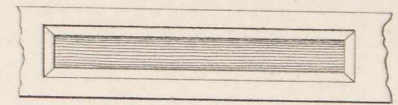

Fig. 93 c.

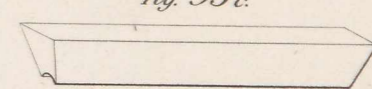

Fig. 94.

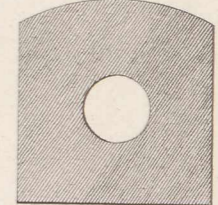

Fig. 87.

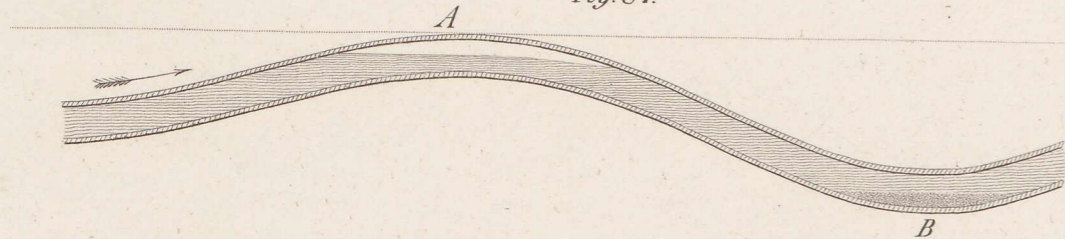

Fig. 91.

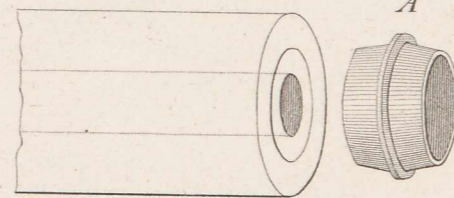

Fig. 92.

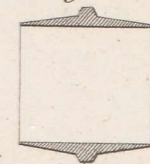

Fig. 96.

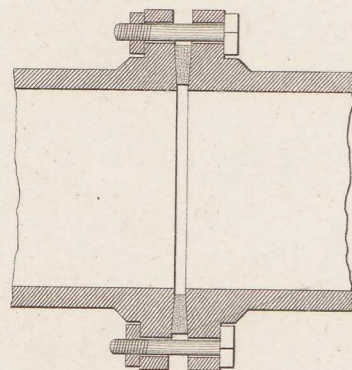

Fig. 97.

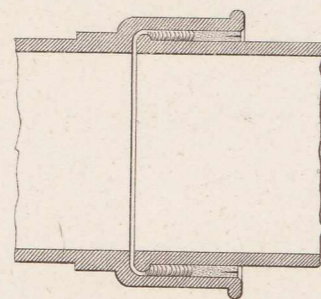

Fig. 95 a.

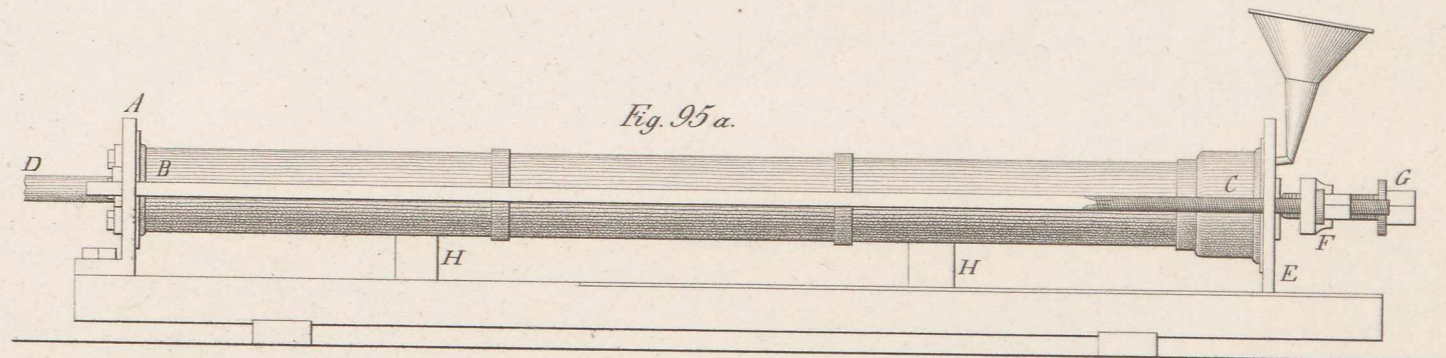

Fig. 98.

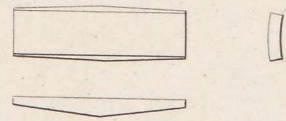

Fig. 100.

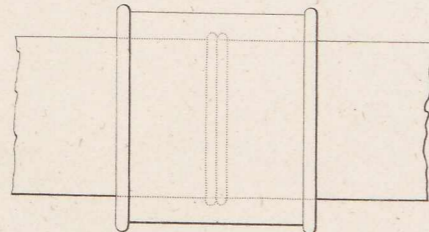
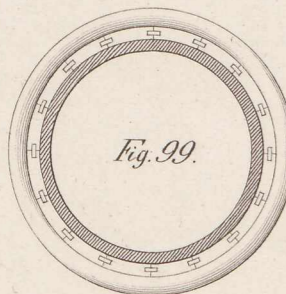

Fig. 99.



zu Fig. 91-92 u. 96-100.
12 6 0 1 1 Lins.

zu Fig. 88-90 u. 93-95.
12 6 0 1 2 3 Lins.

Fig. 95 b.

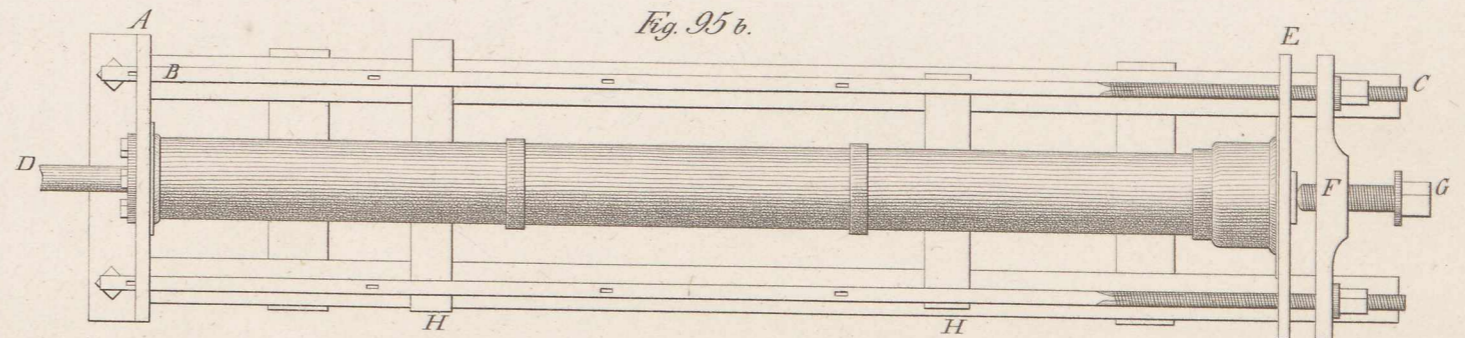

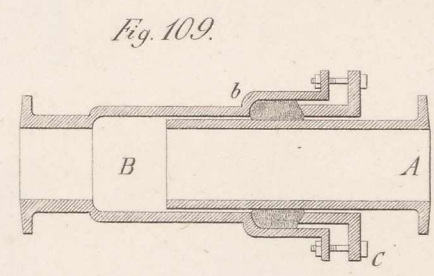
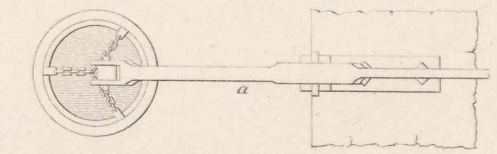
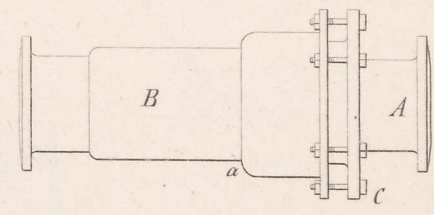
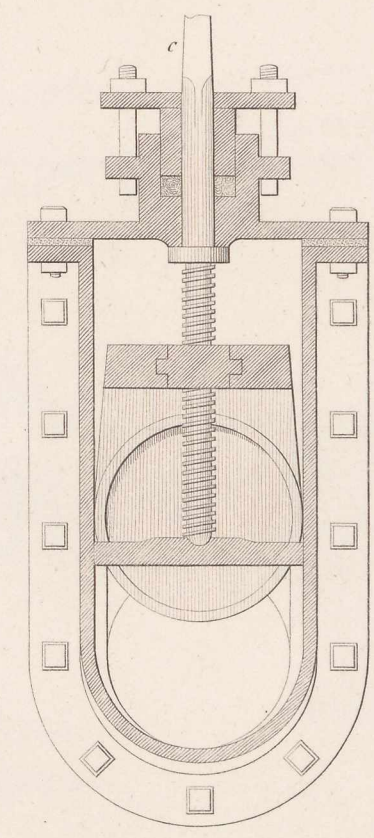
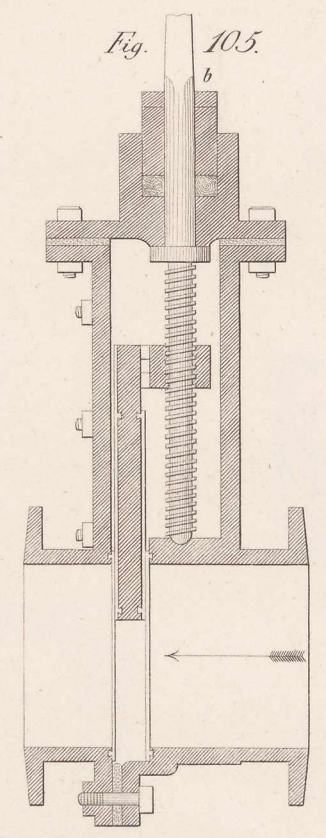
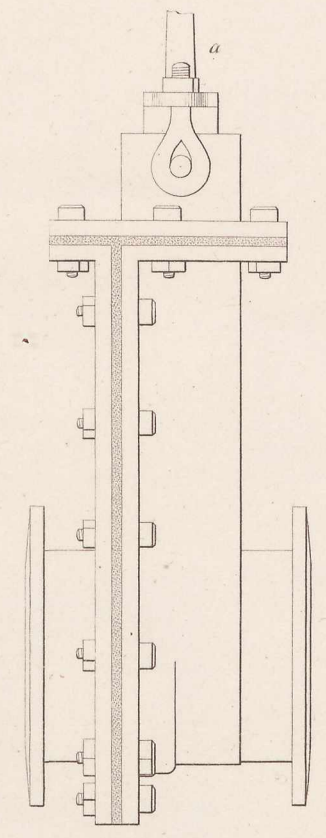
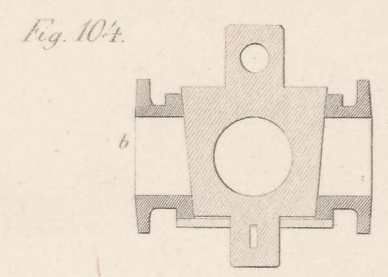
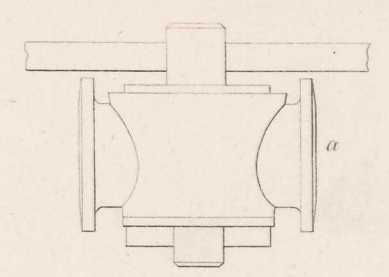
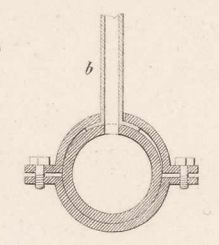
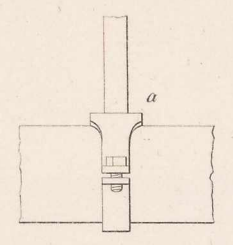
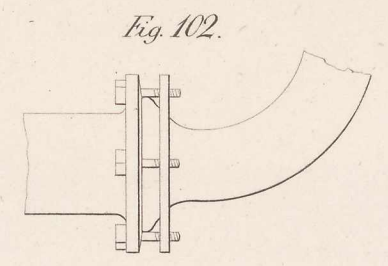
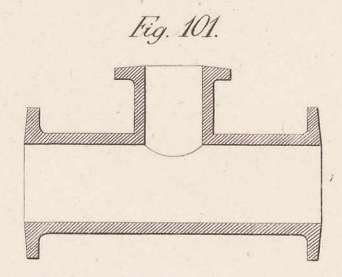

Fig. 107.

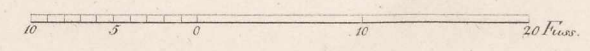
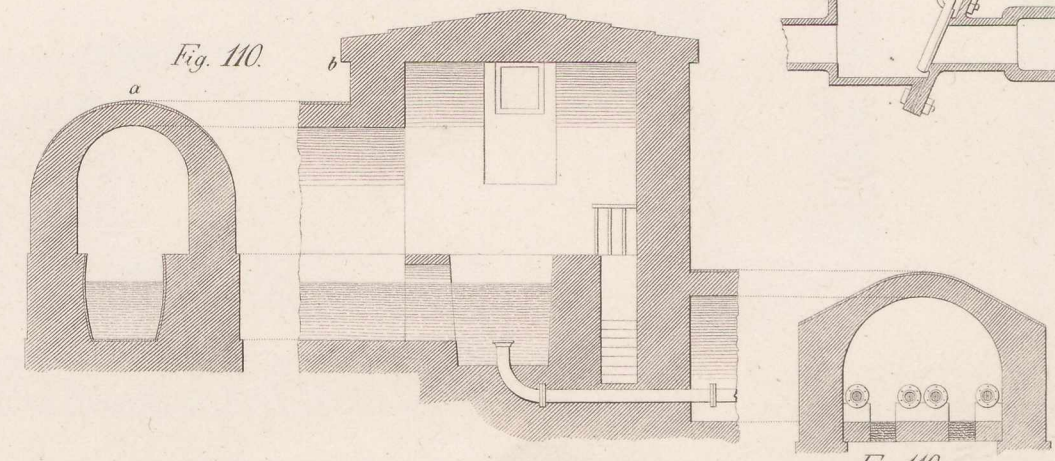
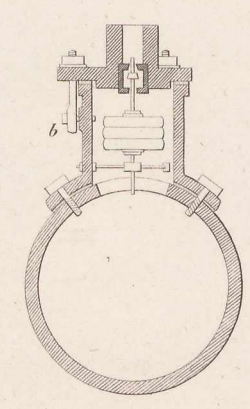
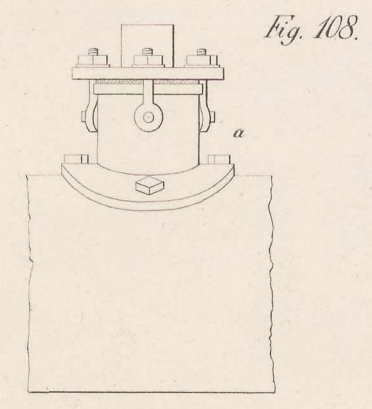
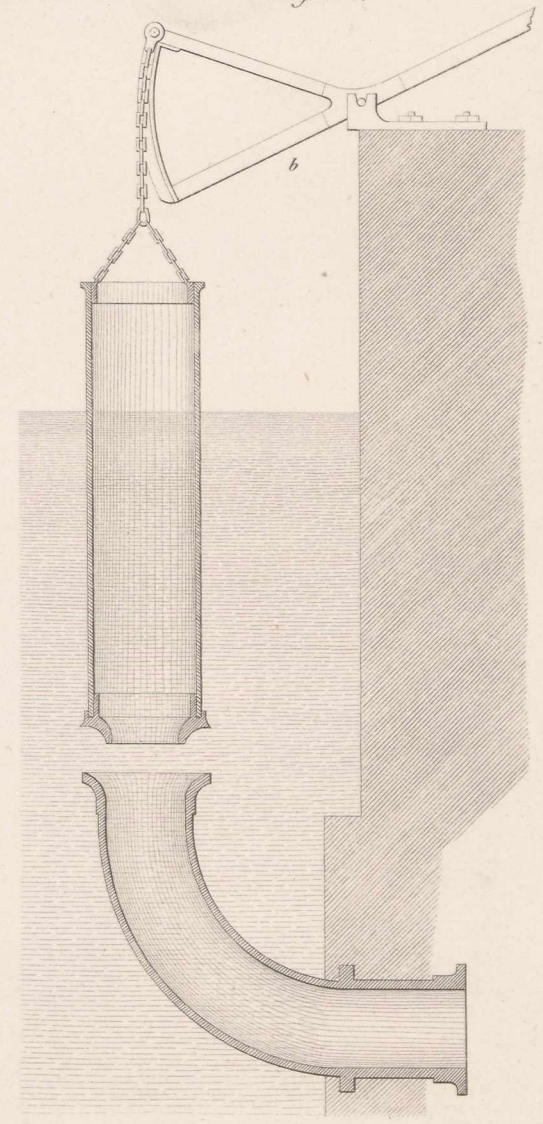
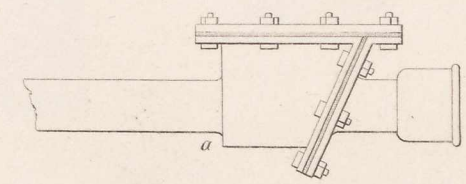

Fig. 110. c.

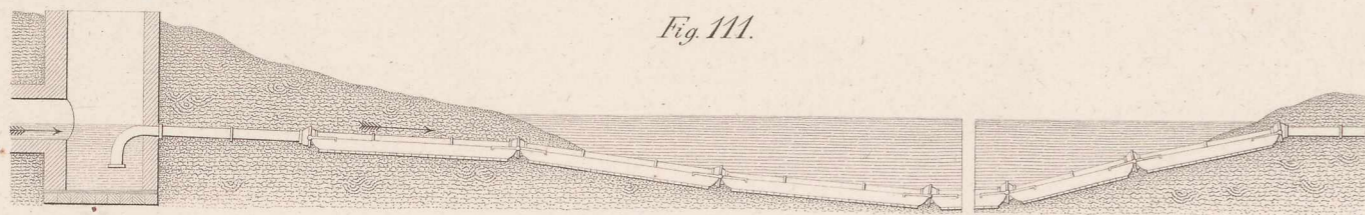
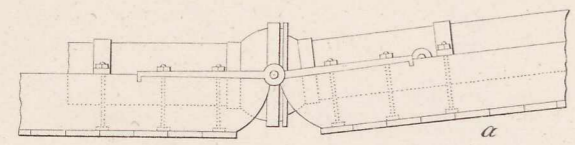
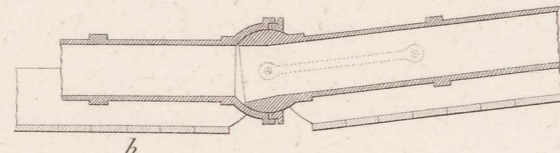

Fig. 111.



a



b

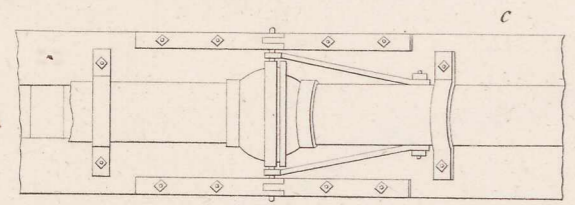

c

Fig. 112.

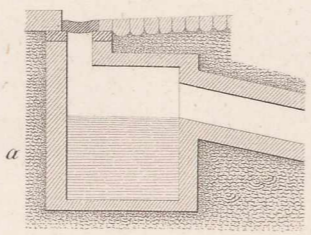

a

Fig. 115.

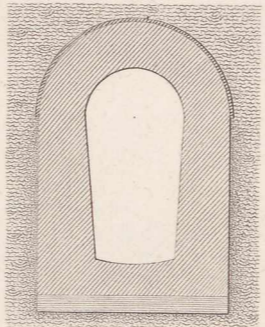

b

Fig. 117.

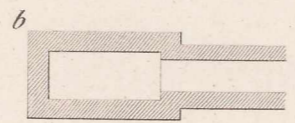

a

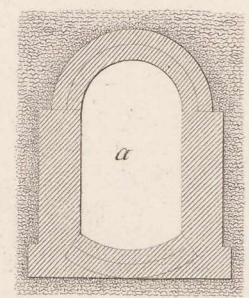

a

Fig. 114.

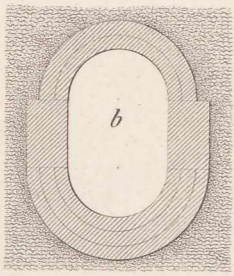

b

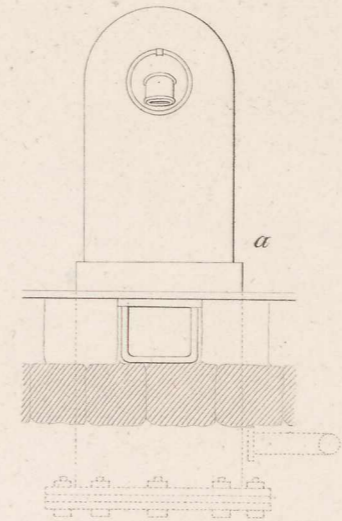

a

Fig. 113.

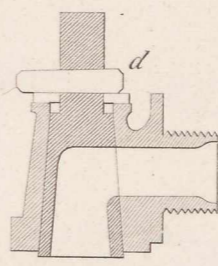

d

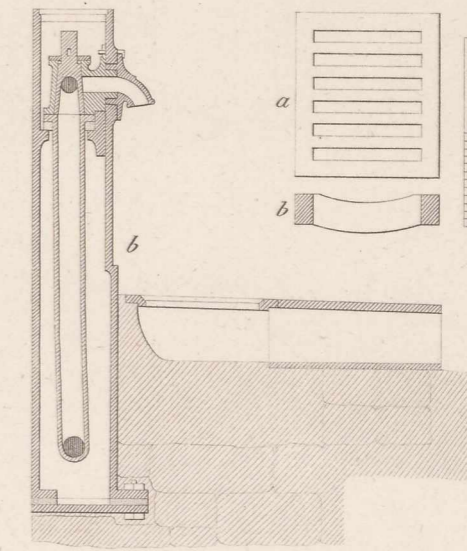

a

b

Fig. 116

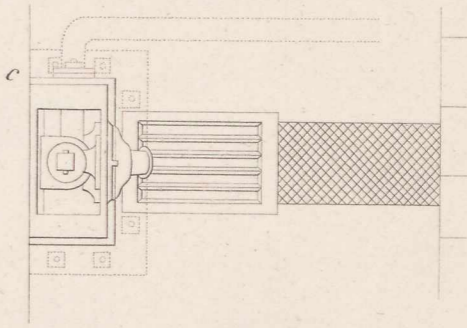

c

Fig. 118.

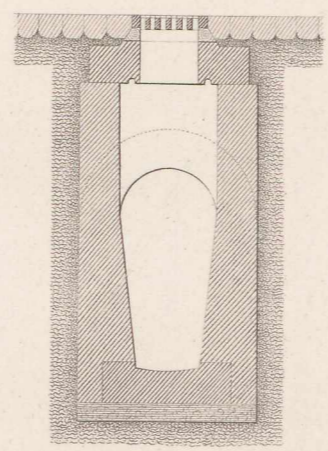

a

Fig. 119.

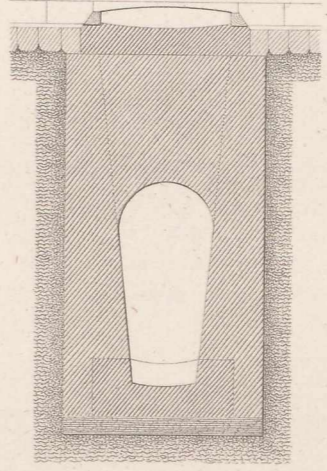

b

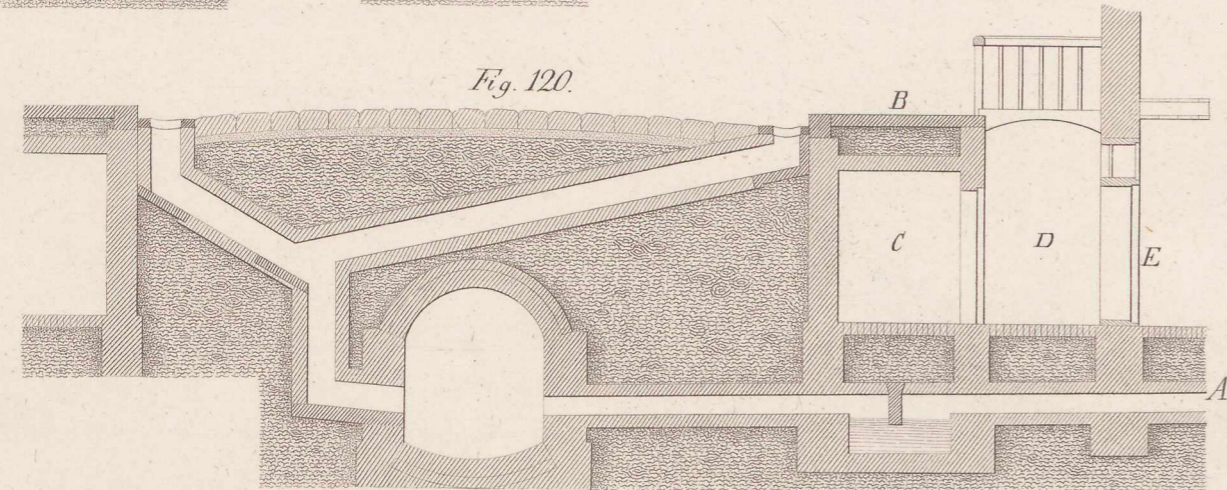
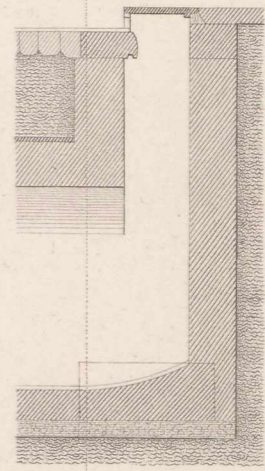

Fig. 120.

10 5 0 10 20 Fuß zu Fig. 120.

10 5 0 1 2 3 Fuß zu Fig. 113 a, b, u. c.

10 5 0 10 Fuß zu Fig. 114, 115, 117-119.

- Haupt-Abzugs Canal.
- Flüsse u. Gräben.
- Wege.
- Dämme.
- Colmations-Bassins.
- Brücken-Canäle.

