

Preliminary computer processing of interferograms – accuracy assessment of the parabolic approximation method of interference fringe midpoint localization from automation intensity scanning*

BOGUSŁAWA DUBIK, WALDEMAR KOWALIK

Institute of Physics, Technical University of Wrocław, Wybrzeże Wyspiańskiego 27, 50-370 Wrocław, Poland.

The operation principle of a programme determining the midpoint positions of interference fringes on the base of the data obtained from scanning arrangement is discussed. The results of testing the programme as well as the measurement errors are given.

1. Introduction

An analysis of interferograms is a tedious and laborous process, particularly when high measurement accuracies are required. Therefore it is reasonable to automatize the whole process as it offers two advantages: considerable reduction of the interference image analysis time, and a possibility of obtaining a detailed information about the examined object with high accuracy [1]. The accuracy of the interference measurements is essentially influenced by both the method of preliminary processing of interferograms and the processing setup used. The arrangements which correctly realize the process of interferogram analysis are, nowadays, few and extremely expensive [1–3]. The search of the best and unexpensive solution is still actual.

In the figure 1 the block diagram of the automation process for interferogram analysis is shown. This process may be realized with the help of different arrangements working in different variants (see fig. 1). The analysis of an interferogram may start either with the recording (by arbitrary technique) of the aerial interference pattern which is followed by reconstruction and scanning by a scanner or with a direct scanning of the aerial image. The scanning device scans the image along some chosen scanning lines. The detector (scanning element) transduces the light intensity distribution along those lines into an analog electric signal. The further run input signal processing depends upon the choice of the method of preliminary interferogram processing.

By preliminary interferogram processing we mean the determination of the positions of light intensity maxima and minima in the interference pattern (the centres of bright and dark interference fringes), as well as the determination of other properties of the analysed interference field, like: the positions of points specified by definite ratios of local-to-extreme intensity (the process of interfringe analysis).

* This paper has been presented at the Fifth Czechoslovakian–Polish Optical Conference in Krpáčová, September, 16–19, 1980.

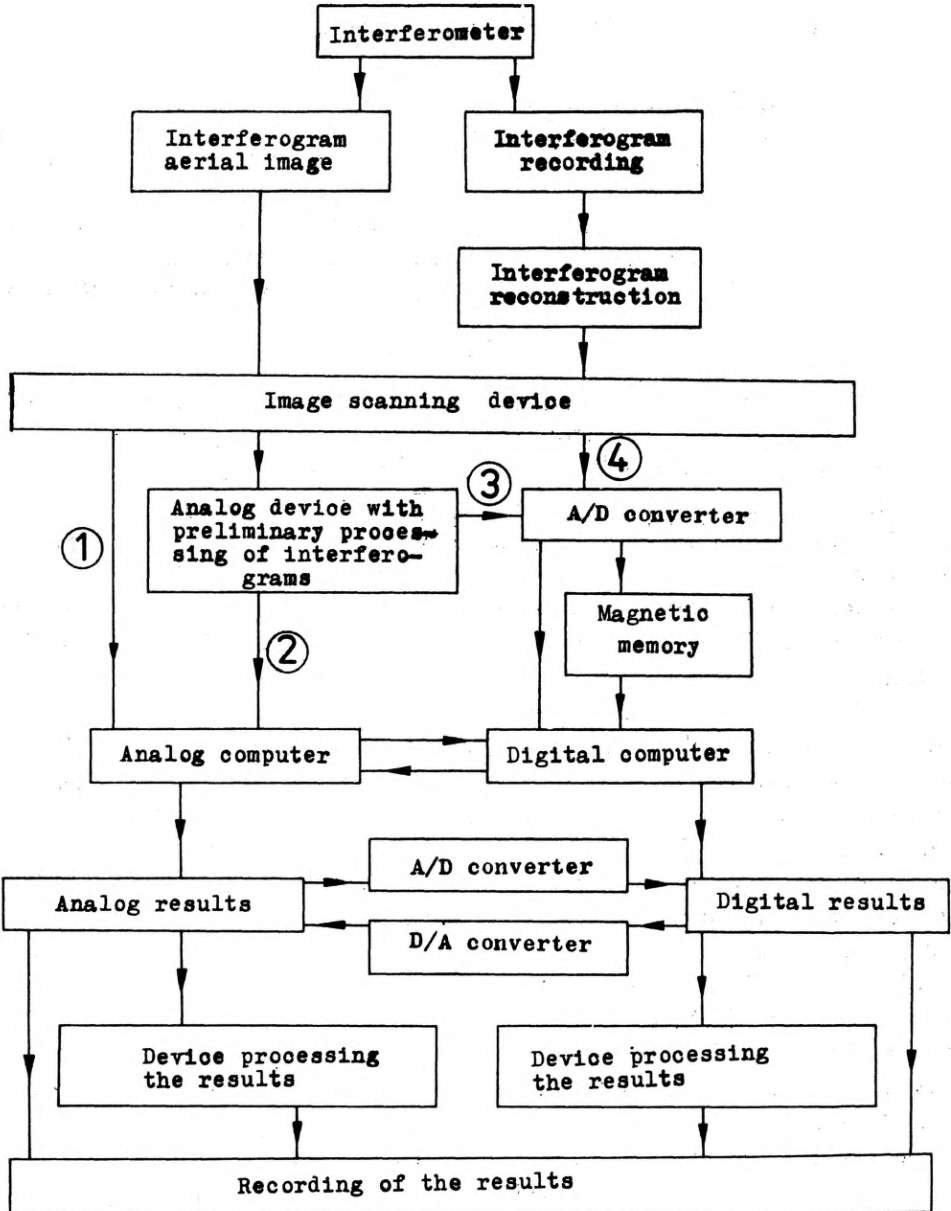

Fig. 1. Block diagram for the process of interferograms analysis automation

In the figure 1 different possible solutions for the preliminary processing of interferograms are marked by numbers from 1 to 4.

Solution 1. It consists in a direct transfer of the analog signal from the scanning device to the electronic analog arrangement. The preliminary processing of interferograms is realized in an analog computer according to a specially elaborated programme. The further processing of preliminary information occurs in analog or digital computer.

Solution 2. Special analog arrangement [1] processes the preliminary data, while the basic calculations are made on an analog computer.

Solution 3. The preliminary process is analogous to that in the solution 2, but the essential calculations are carried out on digital computer after previous analog-to-digital conversion of the signal.

Solution 4. Analog signal from the scanning device is changed in a analog-to-digital transducer into a digital signal, which is either introduced immediately to digital computer or recorded in the memory magnetic one, e.g. to be processed later on a digital computer. In these latter case the preliminary processing of the interferogram occurs in digital computer according to the respective programme. (This paper deals with such a programme). The further calculations of the quantities of interest are made by computer.

The results of calculations may be transduced into a convenient form and recorded.

Since many different interference measurements are carried out at the Institute of Physics, Technical University of Wrocław, Poland, it appeared to be useful to build a scanning device and automatize the whole process of interferogram analysis. An optical-mechanical version of the scanner was decided. In this arrangement the mechanical system assures a precise and accurate movement of the detector along definite scanning lines. The electronic system controls both the driving mechanism shifting the detector and the sampling of the analog signal obtained from the detector. The electronic system assigns a respective quantization level to each sample of the signal (analog-to-digital conversion). The digital signal may be either introduced to the computer or preliminary recorded in the magnetic memory, from which it can be introduced to computer. Preliminary processing of the interferograms being performed in computer, the measurement errors depend on the errors generated by the scanning device as well as on the errors of the method (i.e. of calculation algorithm). This work presents an attempt of made to elaborate and test an algorithm of minimum error. A quick introduction of "unprocessed" digital signal to the computer allows to simplify the scanning device. The process of computer approximation of this signal allows to diminish the influence of the accidental errors (occurring due to additive noises like speckling graininess of emulsion, electronic noise) as the sampling density increases.

2. Programme SCAN

The task of this programme is an accurate determination of the interference fringe midpoint positions on the base of the data supplied by the scanning device from the interferogram. The below analysis of the measurement accuracy concerns only the very method. It does not deal with all the errors generated by the detector [4] (except for the intensity noise) or by the scanning device. In the scanning device the detector changes the light intensity distribution along the scanning line to an analog electric signal. This signal is a function of detector position on the scanning line. The A/D transducer changes the analog signal to a digital one (by quantizing). Such a digital signal, which is an input information for the electronic digital computer, is shown in fig. 2 (the

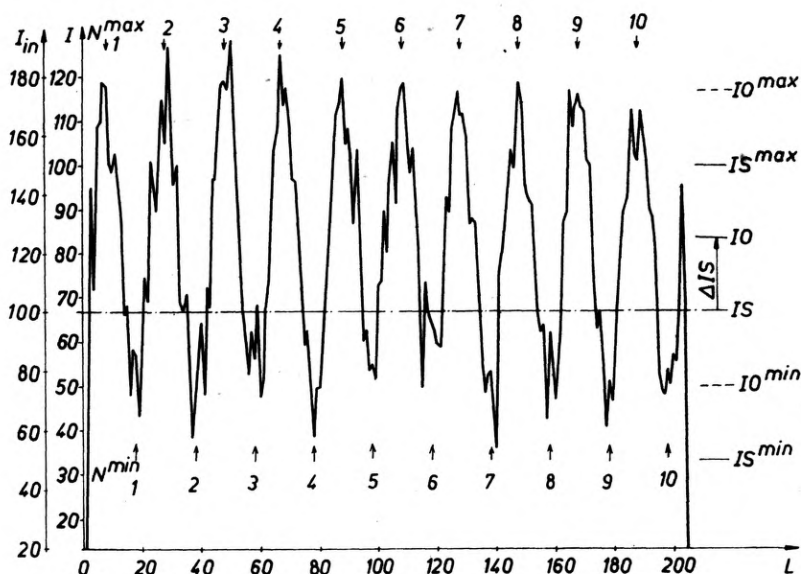

Fig. 2. Testing function for programme SCAN, sequences No. 25 at the noise level $S = 0.75IA$

sampling points being joined with a solid line). On the basis of this signal and the programme SCAN the computer calculates the maximum and minimum values of the light intensities together with their positions on the scanning line. Thus, the programme SCAN realizes the preliminary processing of interferograms. Its principle is simple. For all the scanning lines of the interference pattern, the additional data, like: number of scanning lines, distance from the scanning line origin to the first sampling point on this line, sampling step, maximum and minimum of the expected brightness (IS_{max} and IS_{min}) at the sampling points, zero brightness level, discrepancy level IS of the maxima and minima, minimal number of sampling points PW necessary to distinguish the maxima and minima, are introduced to the computer, beside the digital signal.

In the course of calculations the programme divides the scanning line into intervals, in which the number of successive sampling points is greater than the accepted PW and all the intensity values are above (or below) the IS . Such a procedure allows to eliminate the "false maxima and minima", which due to noises introduced by the speckles, emulsion graininess and the electronic noises. For each interval defined in this way the programme realizes a separate approximation, using second order polynomial and basing on the last-square and orthogonal polynomial method and next — on the basis of the obtained approximating function — it calculates the positions of extremal values (i.e. the maxima and minima). The positions calculated in this way (at every $1/2$ of interfringe distance) correspond to the positions of bright and dark interference fringes on the scanning lines. Beside the basic task, i.e. finding the localization of maxima and minima, the programme may carry out the digital approximation of the input signal (the distribution of the light intensity along the whole scanning line) by using a power polynomial of arbitrary order. Even very complex distributions of light intensity changes may be determined in this way.

3. Testing of the SCAN programme

In order to determine the measurement accuracies, assured by the programme described above, the latter has been accordingly tested. Two light beams, each of intensity IA produce an interference pattern as a result of superposition. The resultant intensity may be described as [5]:

$$I = 2IA(1 + \gamma \cos \delta), \quad (1)$$

where γ — coherence degree of both beams ($\gamma \leq 1$),

δ — phase difference due to optical path difference of both the interfering beams.

This function is always positive, since to function sine or cosine one adds a constant greater than or equal to their amplitude. Such will be also the master function (2) accepted for testing.

In order to examine by which factors and to what degree the measurement accuracy is affected a simulating programme was elaborated in which the testing function depended on the following factors:

1. Sampling density. NP : 100, 50, 20 sampling during one period of sine function. The respective sampling steps are $H = 1, 2, 5$.

2. The amplitude values $IA = 50, 10, 2.5$ input units of intensity.

3. Error ΔIS made when determining the line IS separating the maxima and minima. $\Delta IS = 0, 0.2 IA, 0.5 IA$. We have assumed that this error shifts up the whole testing function by ΔIS with respect to the separating line IS (fig. 2). Hence, the number of sampling for the maxima will be greater than

for the minima, and the shape of the intervals of the sinusoides approximated by second-order polynomial for the maxima and minima will be also different*.

4. Additive noises superimposed on the ideal function $S = 0, 0.01 IA, 0.1 IA, 0.2 IA, 0.3 IA, 0.5 IA, 0.75 IA$. The generation of noises was realized with the help of the random number generator of normal distribution. The maximal noise S corresponds to the cutoff of the normal distribution for random variable value equal to 3σ , where σ is the standard deviation of a normal distribution and $\sigma = 1$.

In the face of above the following form of the ideal function was assumed

$$I_i(L) = IS + IA^* \sin \left[\frac{2\pi}{100} H^*(L-3) \right] \quad (2)$$

with the maxima and minima located at the points (N^{\max}, IS^{\max}) and (N^{\min}, IS^{\min}) (fig. 2). On the base of eq. (2) the following testing function was proposed

$$I(L) = IS + \Delta IS^* + S^*(L) + IA^* \sin \left[\frac{2\pi}{100} H^*(L-3) \right], \quad (3)$$

where L — number of sampling point, while the asterisks denote that the given magnitudes are variable and take the values indicated above. According to (3) all the values $I(L)$ were calculated for $L \in \left(3, \frac{1000}{H^*} + 3 \right)$. It has been assumed that $IS = 100$ output units of intensity. The programme SCAN carried out the normalization of the function (3) so that $(IS + IA)$ at the output took always the value equal to 100 input units of intensity. In this way it was enabling to compare the results for the functions of different values of the amplitude IA . With the help of the simulating programme the calculations were carried out for 27 sequences of parameters given in table 1. Each sequences consisted of 7 scanning lines of different levels of noises S , on each line there appeared 10 maxima and 10 minima of intensity (fig. 2).

The way of error calculation is explained in fig. 3, where one period of the considered ideal function is presented (broken line). The real function is obtained by raising the ideal curve by ΔIS (continuous line) on which the accidental perturbances (noises) are superimposed. The quantized values of the real function (3) are approximated with a polynomial of second power in each of the intervals on the scanning line separately. The extremal positions of the approximated functions (for all ten considered maxima and minima) take different positions on the scanning line (circles in fig. 3). The measurement errors of the position determination for the interference fringe midpoint are given by the differences between the positions obtained by approximation and the respective extrema for the ideal function (2).

* In order to indicate the influence of the sign of the separating line error ΔIS on all the other errors the upper indices "max" and "min" will be used below.

Table 1. Parameters of testing lines

No. of sequences	NP	Theoretical		IA		ΔIS	
		n_{max}	n_{min}	input units	output units	input units	output units
1	100	51	49	50	33.333	0	0
2	100	51	49	10	9.091	0	0
3	100	51	49	2.5	2.146	0	0
4	50	26	24	50	33.333	0	0
5	50	26	24	10	9.091	0	0
6	50	26	24	2.5	2.146	0	0
7	20	11	9	50	33.333	0	0
8	20	11	9	10	9.091	0	0
9	20	11	9	2.5	2.146	0	0
10	100	57	43	50	33.333	10	6.667
11	100	57	43	10	9.091	2	1.818
12	100	57	43	2.5	2.146	0.5	0.488
13	50	28	22	50	33.333	10	6.667
14	50	28	22	10	9.091	2	1.818
15	50	28	22	2.5	2.146	0.5	0.488
16	20	11	9	50	33.333	10	6.667
17	20	11	9	10	9.091	2	1.818
18	20	11	9	2.5	2.146	0.5	0.488
19	100	67	33	50	33.333	25	16.667
20	100	67	33	10	9.091	5	4.545
21	100	67	33	2.5	2.146	1.25	1.219
22	50	34	16	50	33.333	25	16.667
23	50	34	16	10	9.091	5	4.545
24	50	34	16	2.5	2.146	1.25	1.219
25	20	13	7	50	33.333	25	16.667
26	20	13	7	10	9.091	5	4.545
27	20	13	7	2.5	2.146	1.25	1.219

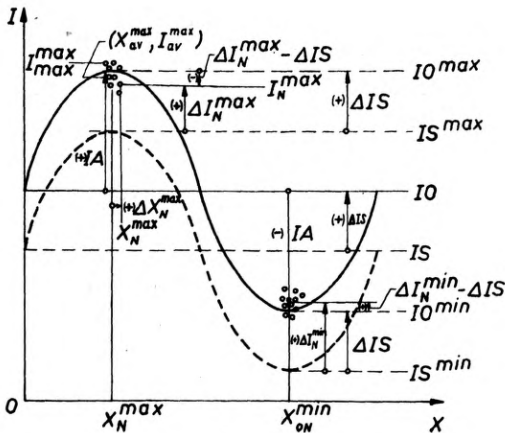

Fig. 3. Measurement error

The errors of the positions of extrema on the scanning line are marked by Δx_N^{\max} , Δx_N^{\min} . For ten considered maxima and minima both maximal (ΔI_{\max}^{\max} , ΔI_{\max}^{\min} , Δx_{\max}^{\max} , Δx_{\max}^{\min}) and minimal (ΔI_{\min}^{\max} , ΔI_{\min}^{\min} , Δx_{\min}^{\max} , Δx_{\min}^{\min}) errors are determined. The average values of the errors have been also calculated for the extreme values of both the intensity and coordinates, for instance, for the coordinate

$$\Delta x_{\text{av}}^{\max} = \frac{1}{10} \sum_{N=1}^{10} \Delta x_N^{\max}.$$

Also, the standard deviation (the square root of the arithmetic mean of the squares of the deviations from the mean) has been calculated for the intensities and coordinates. For instance, standard deviation of the position of intensity maximum centres is

$$\sigma_x^{\max} = \sqrt{\frac{1}{10} \sum_{N=1}^{10} (\Delta x_N^{\max} - \Delta x_{\text{av}}^{\max})^2}.$$

4. Results of testing of the SCAN programme

In the figure 2 an example of a testing function (sequence 25: $IS = 100$ input units of intensity, $IA = 50$ input units of intensity, $\Delta IS = 0.5 IA$, $S = 0.75 IA$) is shown. Of 20 sampling points falling to one period of this function from which 13 sampling points serve theoretically for determination of the maximum and 7 sampling points — for minimum. The results obtained for this sequence are presented in table 2. Within this sequence the averaged values of the errors in intensity are of interest. The differences among these errors for the maxima and minima are easily seen. The average error in intensity $\Delta I_{\text{av}}^{\max}$ for the maxima is distinctly lower than that for the minima $\Delta I_{\text{av}}^{\min}$. The dispersion of errors around the average value of the extreme intensity ($I_{\text{av}} = IS + IA + \Delta I_{\text{av}}$) being described by the average standard deviation σ_I . Here $\sigma_{I_{\min}} > \sigma_{I_{\max}}$, the dispersions of errors in determination of minima are greater than those for the maxima.

The error $(\Delta I - \Delta IS)_{\text{av}}$ represents the imperfection of the approximation process due to approximation of the sine and cosine functions by a polynomial of second power. This error produces a shift of the extreme values of the approximated function observed usually in the direction of the separating line IS (fig. 3.) This error is greater when the maximum being determined and smaller in the case of minimum.

Similar dependences occur also for the errors of positions of extreme intensities. The errors of intensity determination depend upon the intensity amplitude. In order to make the errors independent of amplitude for normalized results the latter were represented in units corresponding to percent of amplitude.

Table 2. Results of sequences No. 25 at the noise level $S' = 0.75 IA$

N	Maxima				Minima			
	ΔI_{N}^{\max}	$\Delta I_{N}^{\max} - \Delta IS$	Δx_{N}^{\max}	n_{N}^{\max}	ΔI_{N}^{\min}	$\Delta I_{N}^{\min} - \Delta IS$	Δx_{N}^{\min}	n_{N}^{\min}
1	12.96	-3.706	1.776	10	15.08	-1.586	5.479	4
2	11.08	-5.586	-0.447	14	24.93	8.264	7.684	5
3	22.20	5.534	2.317	12	28.94	12.274	-4.492	3
4	16.10	-0.566	1.319	12	11.07	-5.596	3.560	7
5	12.80	-3.866	1.189	11	19.03	2.364	3.072	4
6	10.10	-6.566	-0.173	14	25.41	8.744	13.79	3
7	10.68	-6.026	-2.203	12	20.01	3.344	-3.533	5
8	8.96	-7.706	-2.036	13	18.22	1.554	4.048	7
9	16.92	0.254	-0.448	10	11.84	-4.826	-0.074	6
10	6.966	-9.7	0.218	13	15.72	-0.946	-10.090	7

$\Delta I_{\max}^{\max} = 22.20$	$\Delta x_{\max}^{\max} = 2.317$	$\Delta I_{\max}^{\min} = 28.94$	$\Delta x_{\max}^{\min} = 13.79$
$\Delta I_{\min}^{\max} = 6.966$	$\Delta x_{\min}^{\max} = 0.1728$	$\Delta I_{\min}^{\min} = 11.07$	$\Delta x_{\min}^{\min} = 0.0742$
$\Delta I_{\text{av}}^{\max} = 12.87$	$\Delta x_{\text{av}}^{\max} = 0.1512$	$\Delta I_{\text{av}}^{\max} = 19.03$	$\Delta x_{\text{av}}^{\min} = 1.945$
$\sigma_I^{\max} = 4.241$	$\sigma_x^{\max} = 1.446$	$\sigma_I^{\min} = 5.630$	$\sigma_x^{\min} = 6.436$
$(\Delta I_{\max} - \Delta IS)_{\text{av}} = -3.793$		$(\Delta I_{\min} - \Delta IS)_{\text{av}} = 2.359$	
	$n_{\text{av}}^{\max} = 12.1$		$n_{\text{av}}^{\min} = 5.1$

The error ΔIS of level IS affects also the total error of intensity evaluation. Therefore, the average and maximal errors associated with the normalized results do not contain the error ΔIS . Hence, the total errors of extreme intensity determination are the sum of errors, for instance, average or maximal ones (read out from the graphs in figs. 4, 5, 7, 8) and of the error $\frac{\Delta IS}{IA} 100$.

The errors of extreme intensity determination are represented as percents of the interfringe distance. All the normalized errors depend on the number of samplings n used for determining the extreme value and on the maximal noise to the intensity amplitude ratio S/IA . The dependences shown in figs. 4 and 5 representing the error of approximation of the "halves" of the sinusoids by the polynomial of second power are very interesting. Its asymmetry of this error for maxima and minima indicates that such an approximation is not good enough and depends in a complex way on S/IA and n . General properties of the errors of intensity determination in extrema are following:

1. The errors diminish with the increasing number of sampling points (figs. 4-8).
2. The errors increase with the increase of noise and their dependence on the number of sampling points becomes more nonlinear (figs. 4-8).
3. Errors due to approximation by second-order polynomials shift usually the extremal intensity in the direction of the separating line IS . Some asymmetry of this effect appears to be caused by the error ΔIS .

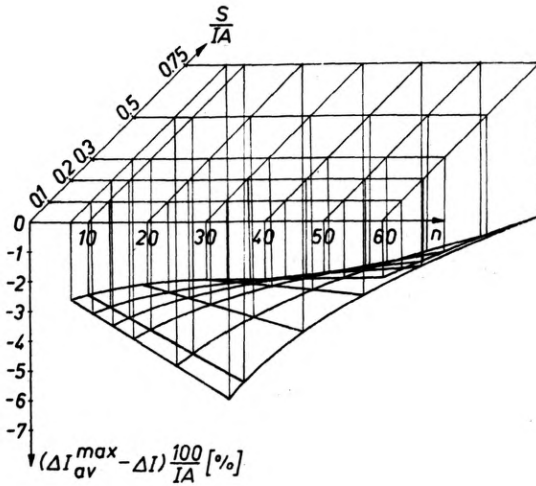

Fig. 4. Average error in the intensity maximum determination

4. The total average or maximal errors are sum of errors presented in figs 4-8 and of the error $\frac{\Delta IS 100}{IA}$.

The properties of the errors in extreme intensity positions are the following:

- i) The errors diminish with the increasing number of sampling points (fig. 9-11).
- ii) The errors increase with the increase of noise and their dependence on the number of sampling points becomes more nonlinear (figs. 9-11).
- iii) The error ΔIS influences only the number of sampling points thus indirectly affects the total error in extreme intensity position determination
- iv) Errors for maxima and minima are identical (figs. 9-11).

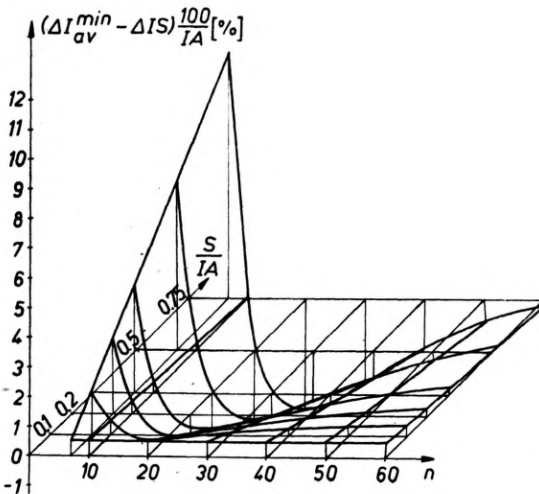

Fig. 5. Average error in the intensity minimum determination

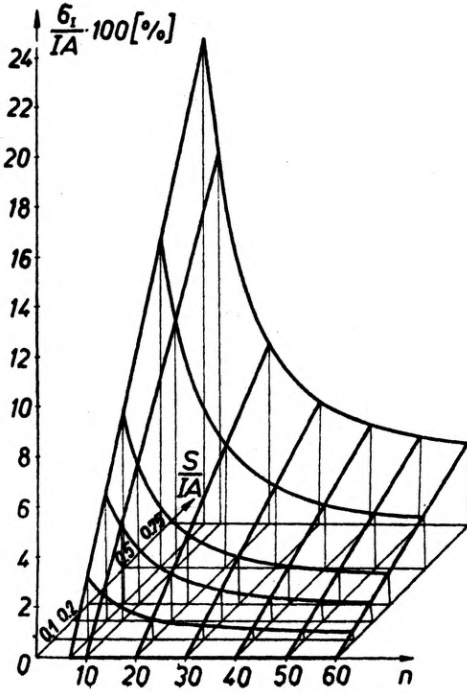

Fig 6. Standard deviation in determining the extreme intensity

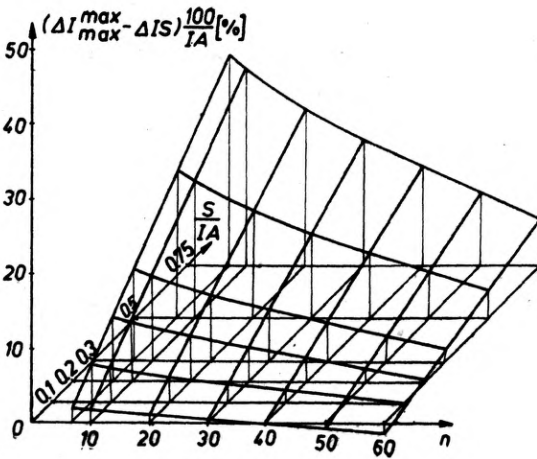

Fig 7. Maximal error in determining the intensity maxima

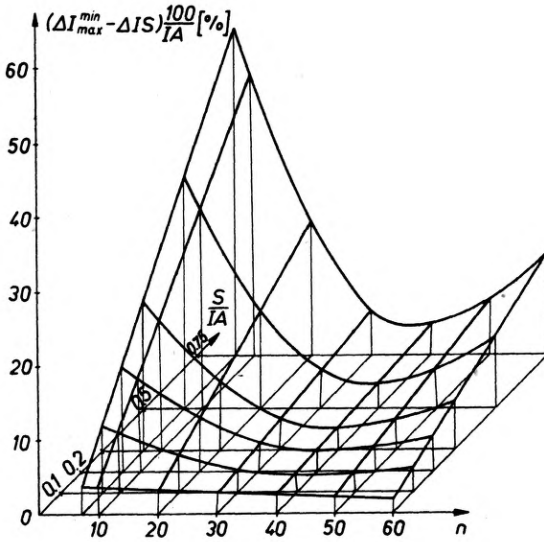

Fig. 8. Maximal error in determining the intensity minima

v) Errors are symmetrically distributed around ideal value. They may be both positive and negative and take all the possible values being restricted only by their maximal values. Hence, the figs. 9 and 11 present only the absolute limits of these errors.

5. Final remarks

The above conclusions and the dependences obtained allow to choose such parameters of the scanning device (its noises and the sampling density) that the achievement of the desired measurement accuracy be possible. As it may be seen the accuracy in determining the positions of the interference fringe centres of order of 0.01 of interfringe distance (1%) can be easily obtained. For very

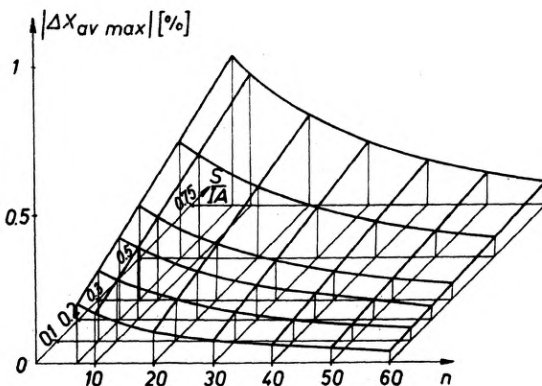

Fig. 9. The greatest average error in determining the extreme intensities

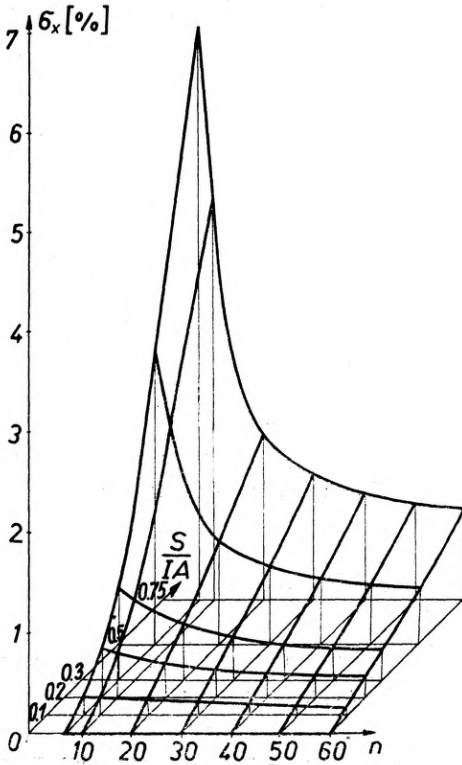

Fig. 10. Standard deviation in determining the extreme intensity positions

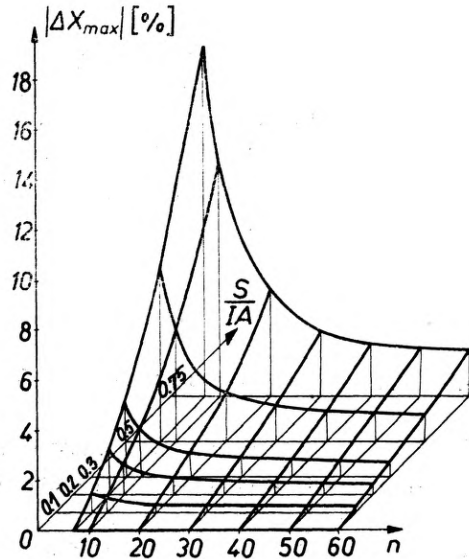

Fig. 11. The greatest maximal error in determining the extreme intensity positions

small noises and great number of sampling points this accuracy may be increased to reach 0.001 of the interfringe distance (0.1 %).

The task to be solved by this programme (exact determination of the extreme intensity position) is thus achieved.

Somewhat different is the problem of determining the extreme intensity values. In this case the error of the approximating method (the selected method of approximation) is considerable. The errors of intensity have been discussed here having in mind certain conclusions necessary for preparation of the next programme which would allow to extract information about the difference in optical paths from the interfringe intensity distribution (interfringe scanning) [1]. Such a procedure will improve both measurement accuracy and fidelity of the distribution (increasing during the obtained information). This programme will determine the positions of points on the scanning line which correspond to optical path differences, for instance, each 0.01 λ .

From the above discussion it follows that in the future programme the method of intensity function approximation must be changed (for instance the power polynomial be replaced by trigonometric ones) in order to assure

a more faithful reconstruction of the intensity function. Interfringe scanning should contain the corrections including: changes in intensity occurring in particular extrema (result of nonuniformity of interferogram illumination) and as well as shape and size of the detector nonlinear character of response, etc.

References

- [1] ROBLIN G., PREVOST M., *A Method to Interpolate Two-Beam Interference Fringes*, Proceedings of ICO-11 Conference, Madrid, Spain, 1978, p. 667.
- [2] HUNTOON R. D., et al., *J. Opt. Soc. Am.* **44** (1954), 264-269.
- [3] BRUNING J. H., et al., *Appl. Opt.* **13** (1974), 2693-2703.
- [4] RAYMOND O. J., *Appl. Opt.* **9** (1970), 1140.
- [5] BORN M., WOLF E., *Principles of Optics*, Pergamon Press, Oxford, London 1964, p. 259.

Received June 3, 1980,

In revised form September 6, 1980

Предварительная компьютерная обработка интерферограмм —

Оценка точности метода локализации центров интерференционных линий из автоматического интенсивностного сканинга с применением параболической аппроксимации

Представлен принцип действия программы, определяющей положение центров интерференционных линий на основе данных, полученных из сканирующего устройства. Приведены результаты тестирования этой программы, а также измерительные ошибки метода.