



L 2379

re











~~HOH HAUSCHULE  
BRESLAU.~~

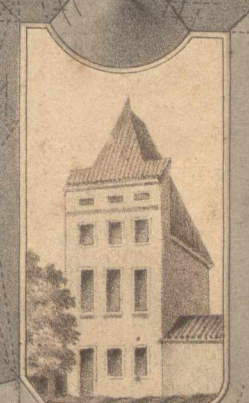
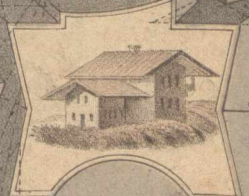
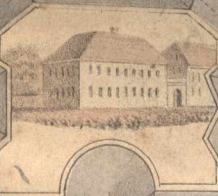
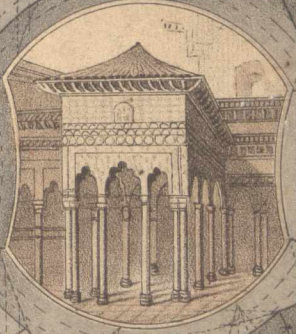
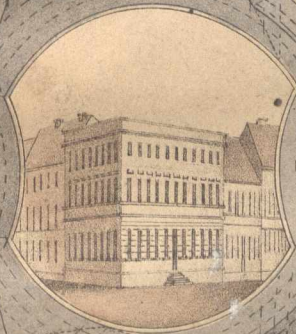
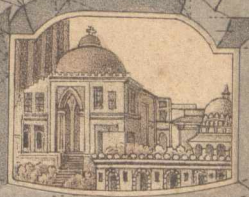

Sechs u. dreißig Tafeln  
 Abbildungen  
 zu  
 Hermann Hederich's  
 Elemente der Dachformen

Weimar.  
 C. F. A. Kühn  
 1858.  
 Lith. Anstalt von Fr. Walther. sen.

1942 a 1072

BIBLIOTHEK d. TECHNISCHEN  
HOCHSCHULE  
BRESLAU  
ABT. d. ST. u. UNIV.-BIBL.

~~HOH KUNSTSCHULE  
BRESLAU.~~



BIBLIOTHEK d. TECHNISCHEN  
HOCHSCHULE  
BRESLAU  
ABT. d. ST. u. UNIV.-BIBL.

*Inv. 2000.*



Taf. I.

Fig. 1-13.



Fig. 1.

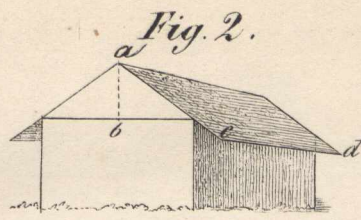

Fig. 2.

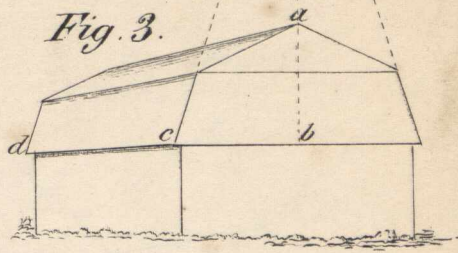

Fig. 3.

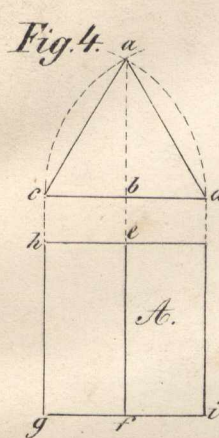

Fig. 4.

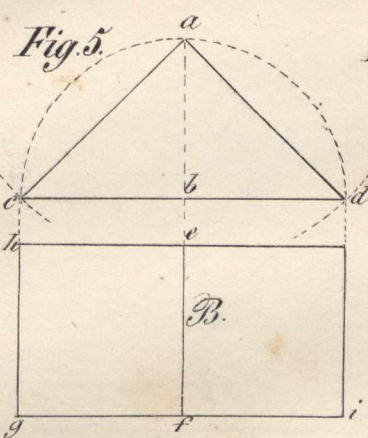

Fig. 5.

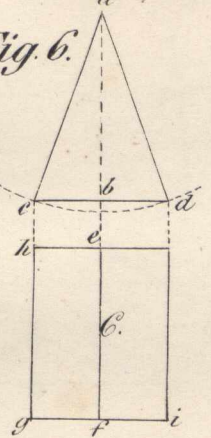

Fig. 6.

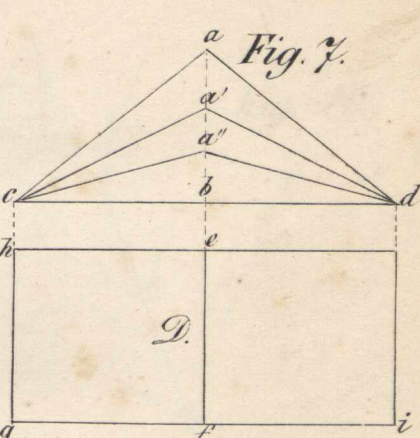

Fig. 7.

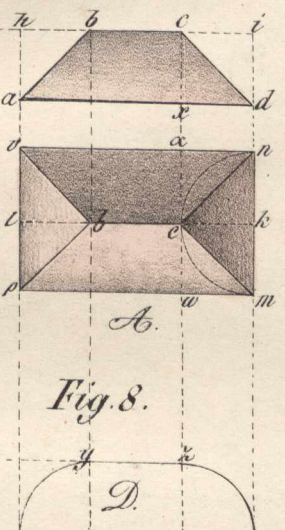
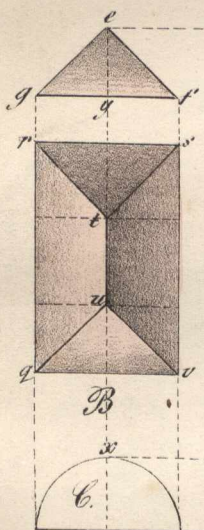

Fig. 8.

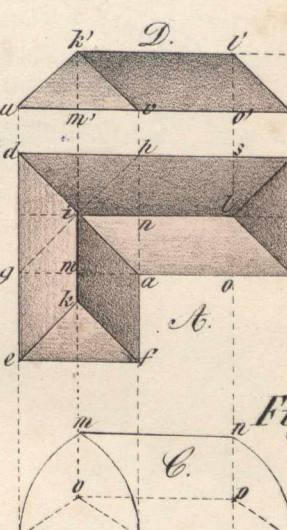

Fig. 9.

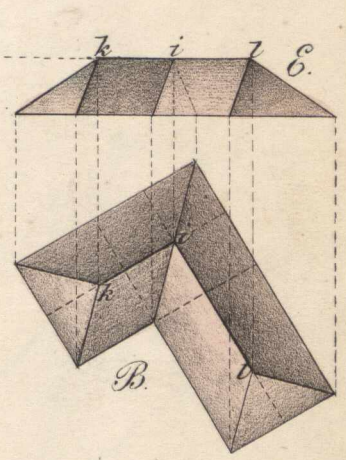

Fig. 10.

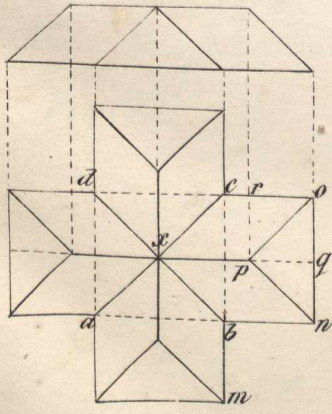

Fig. 11.

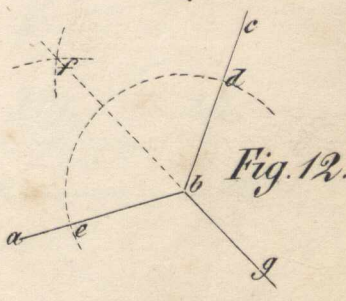
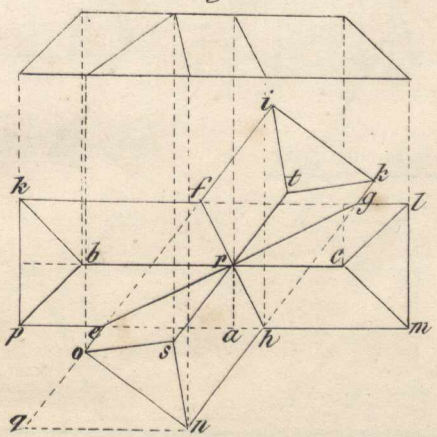

Fig. 12.

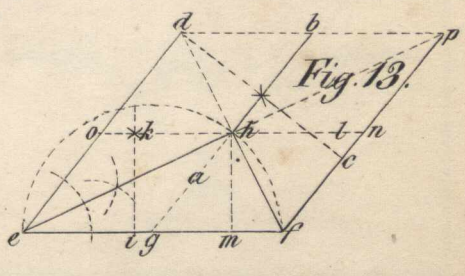

Fig. 13.



UNIVERSITÄT  
BRESLAU

BIBLIOTHEK d. TECHNISCHEN  
HOCHSCHULE  
BRESLAU  
ABT. d. ST. u. UNIV.-BIBL.



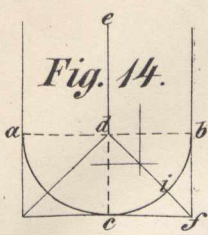

Fig. 14.

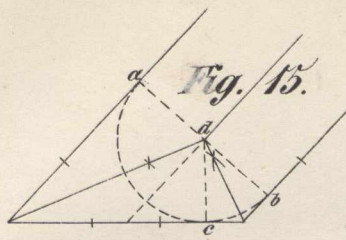

Fig. 15.

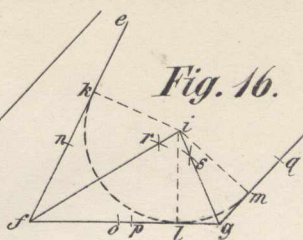

Fig. 16.

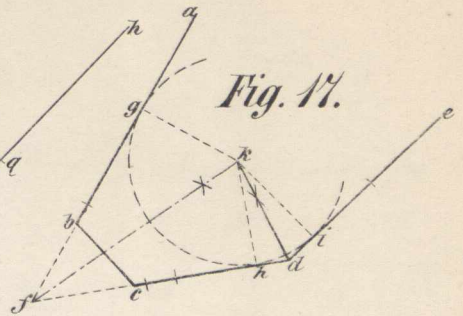

Fig. 17.

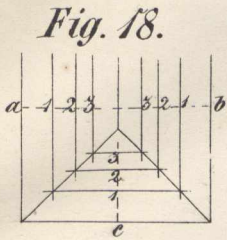

Fig. 18.

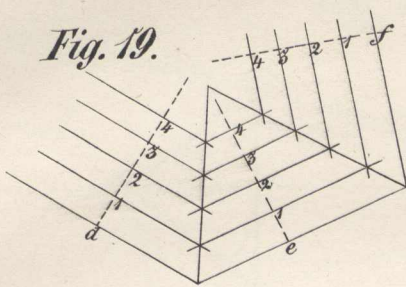

Fig. 19.

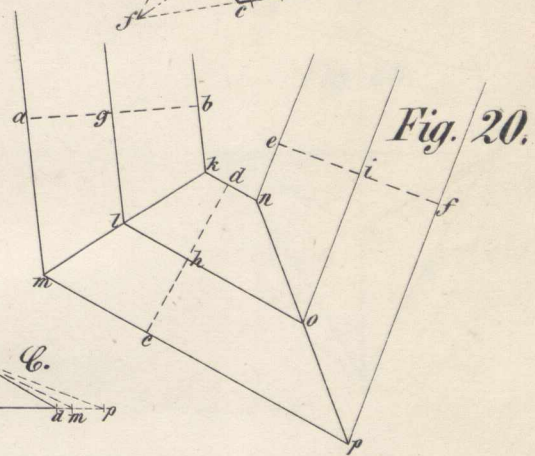
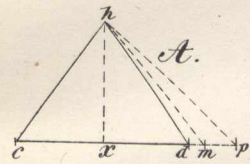
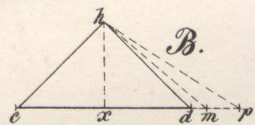

Fig. 20.



A.



B.

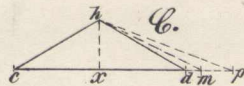

C.

Fig. 21.

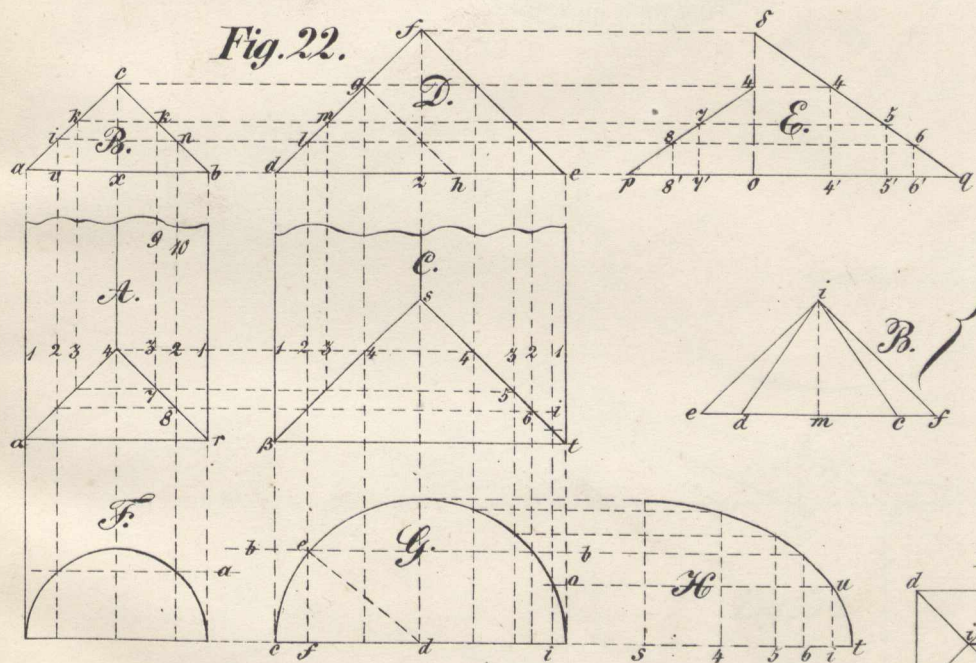

Fig. 22.

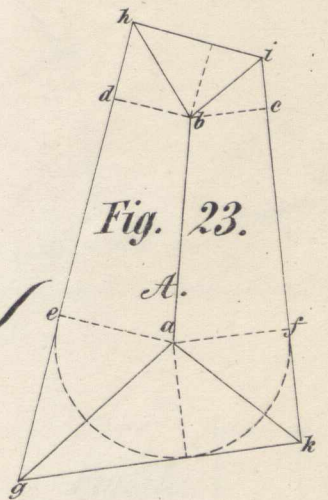

Fig. 23.

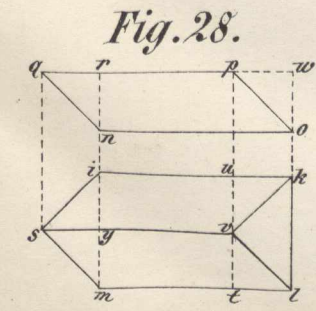

Fig. 28.

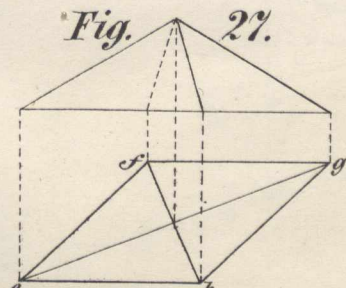

Fig. 27.

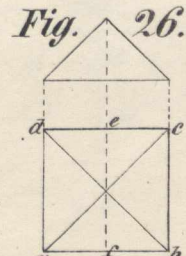

Fig. 26.

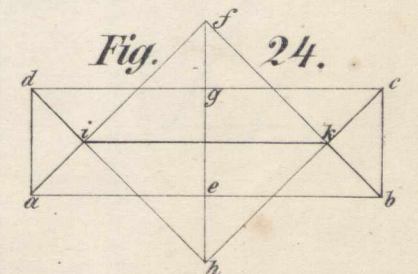

Fig. 24.

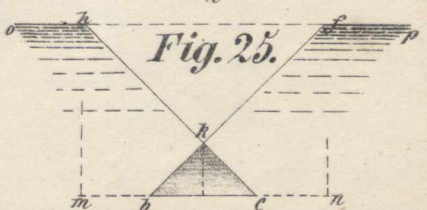
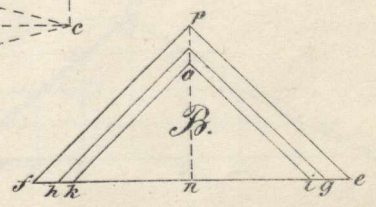
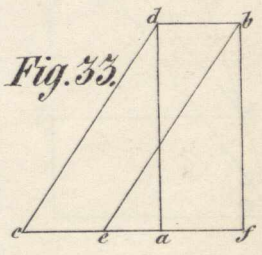
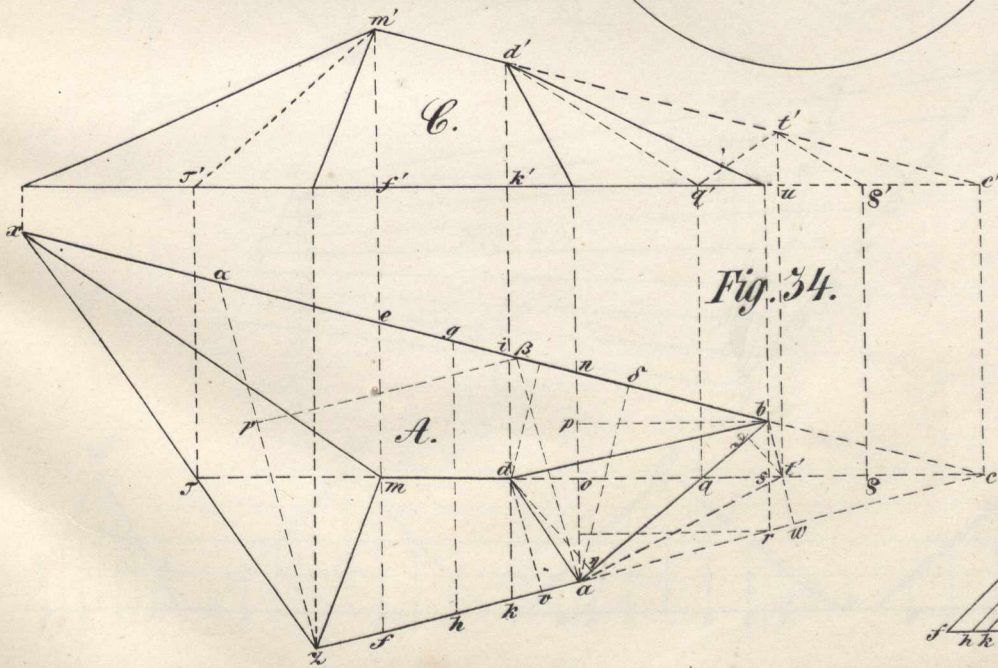
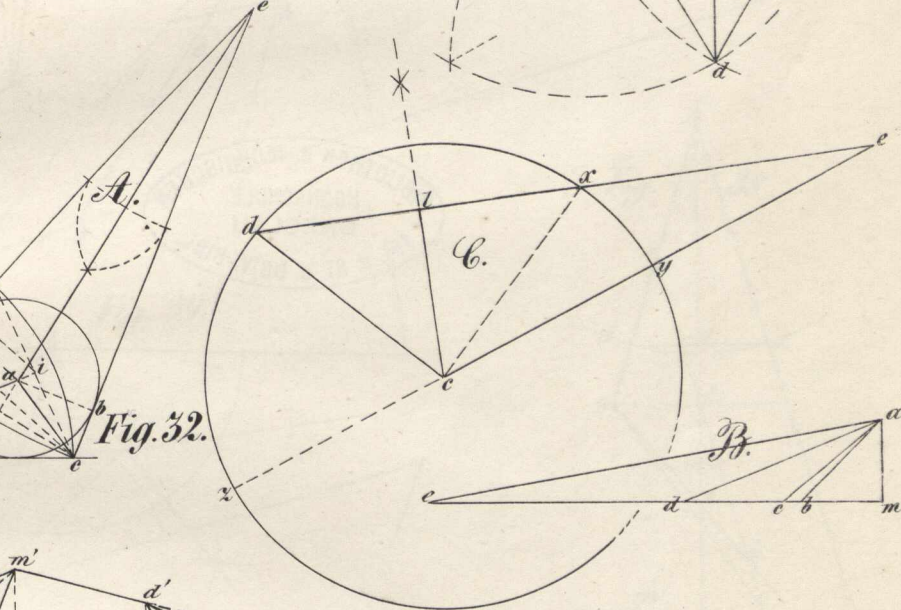
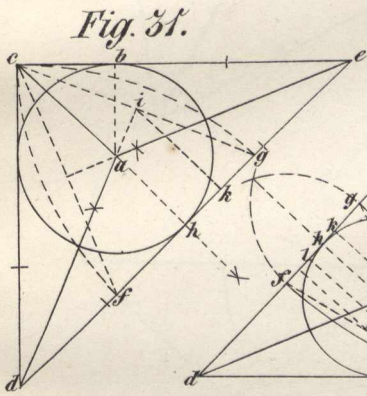
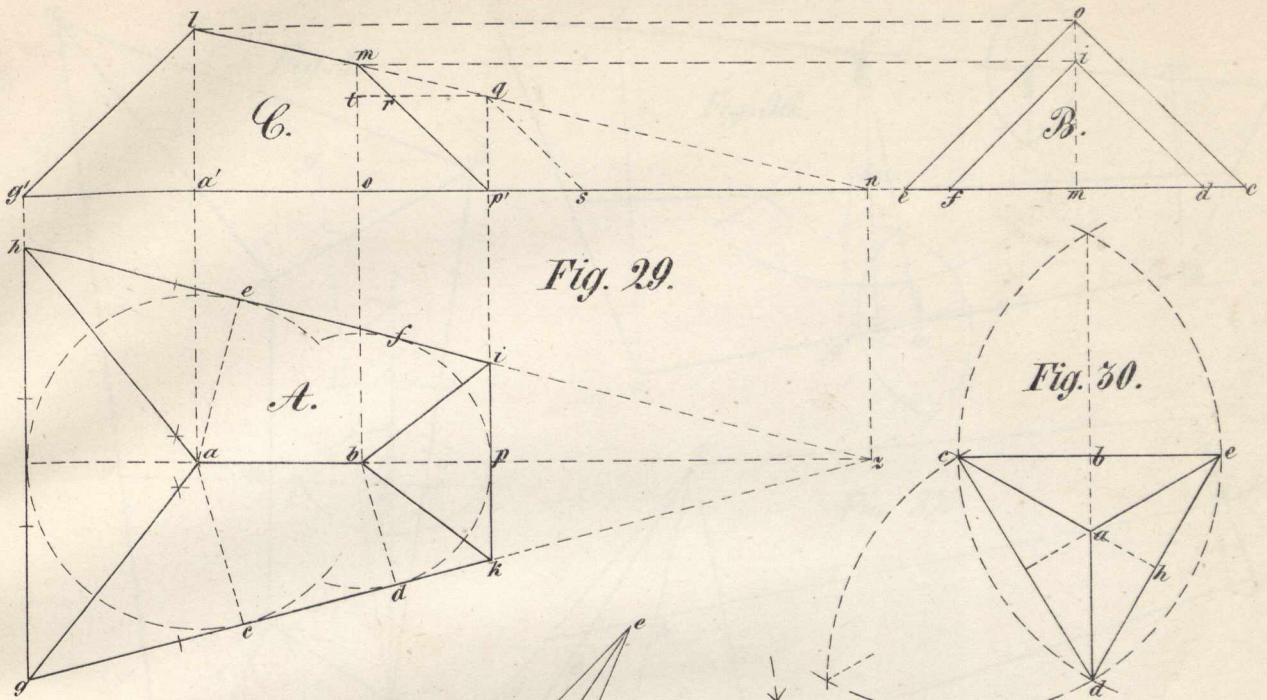

Fig. 25.



BIBLIOTHEK d. TECHNISCHEN  
HOCHSCHULE  
BRESLAU  
ABT. d. ST. u. UNIV.-BIBL.







BIBLIOTHEK d. TECHNISCHEN  
HOCHSCHULE  
BRESLAU  
ABT. d. ST. u. UNIV.-BIBL.



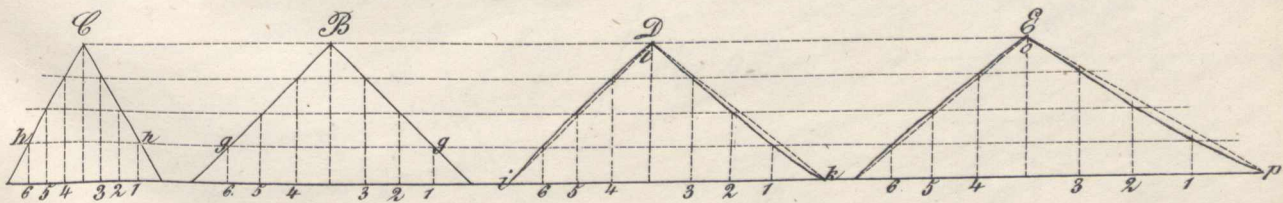
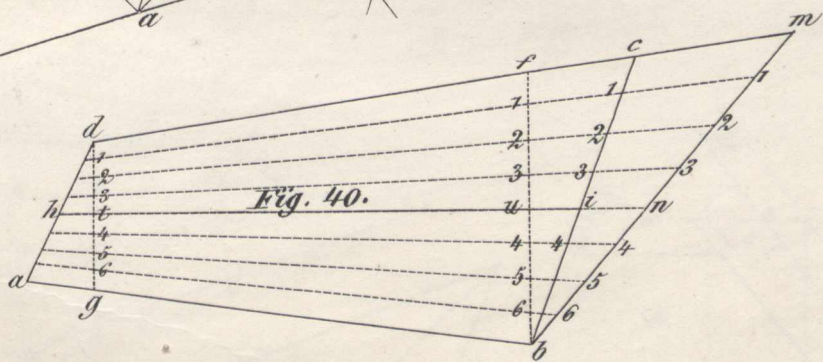
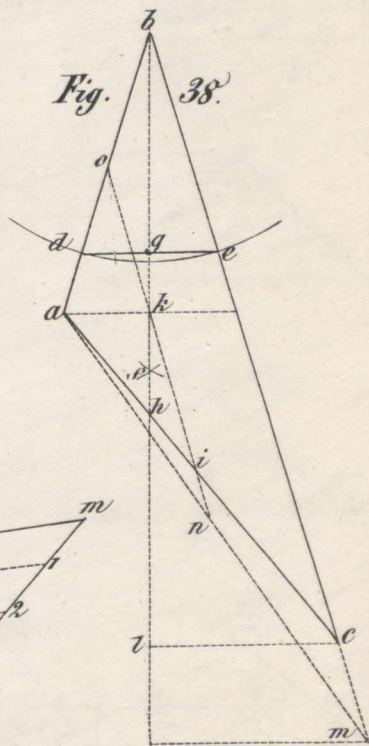
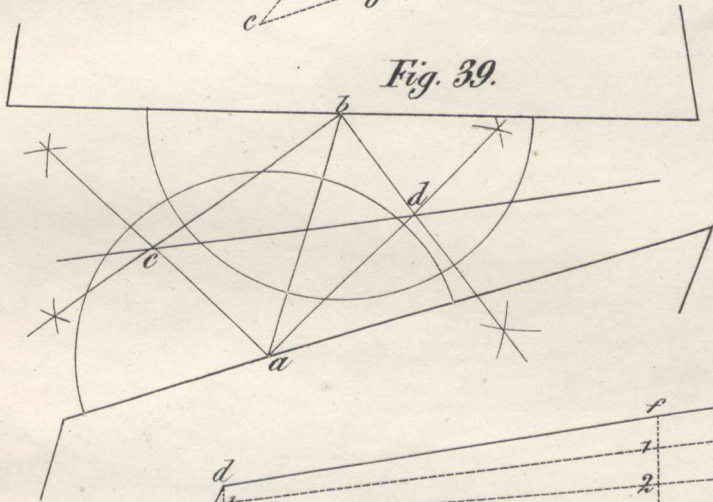
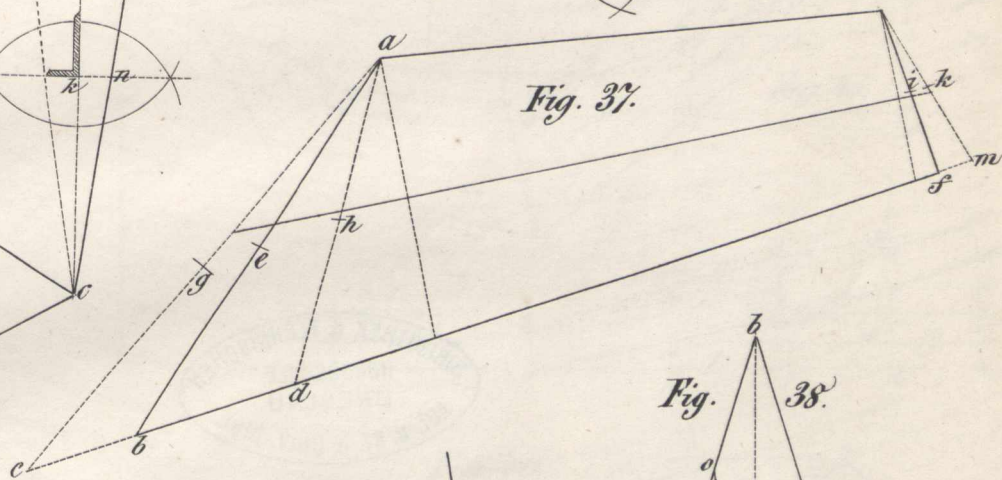
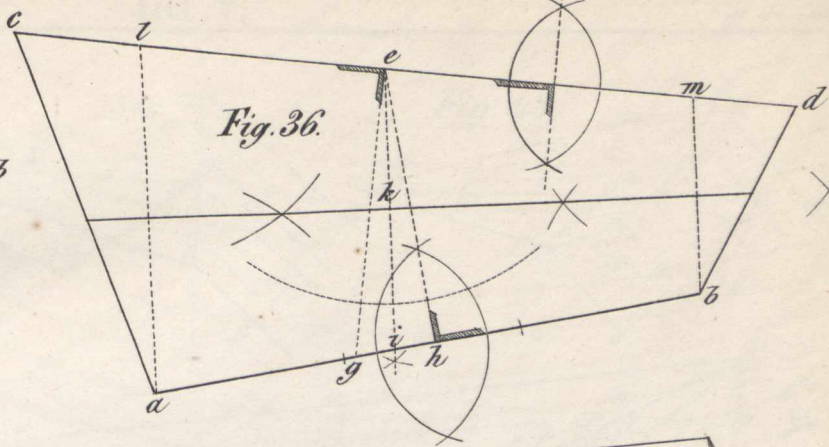
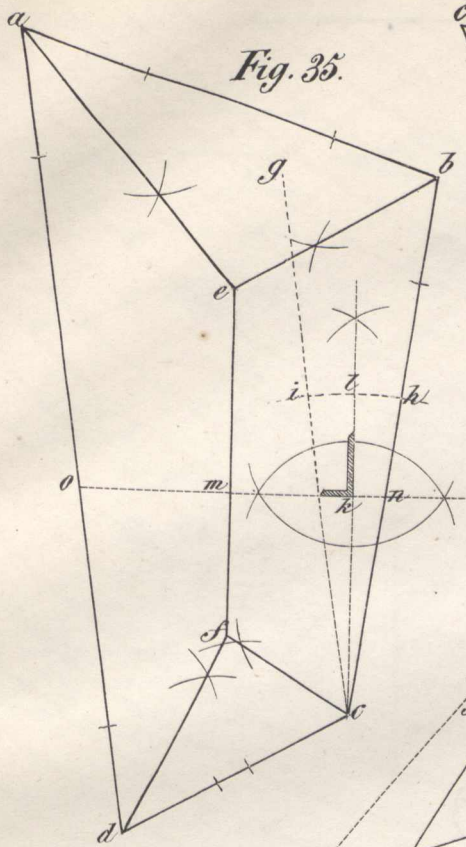



BIBLIOTHEK d. TECHNISCHEN  
HOCHSCHULE  
BRESLAU  
ABT. d. ST. u. UNIV.-BIBL.



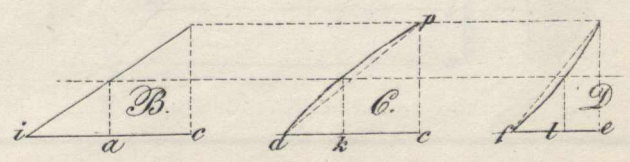
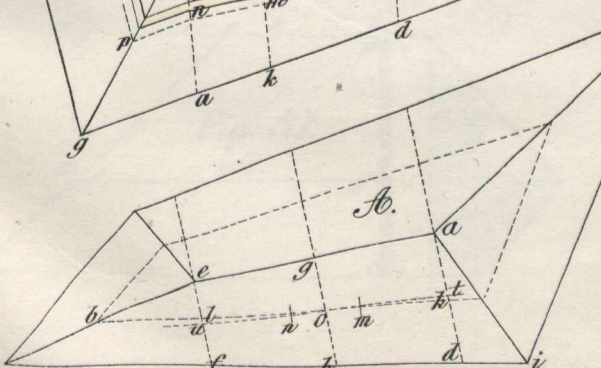
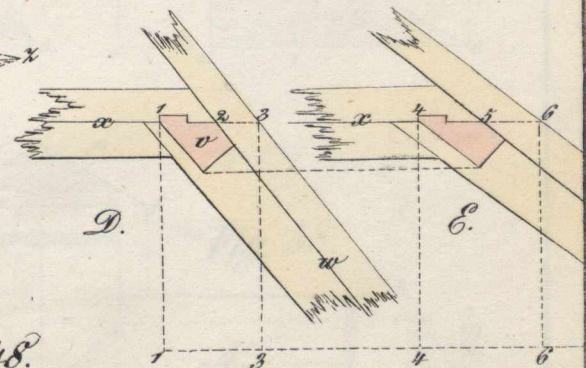
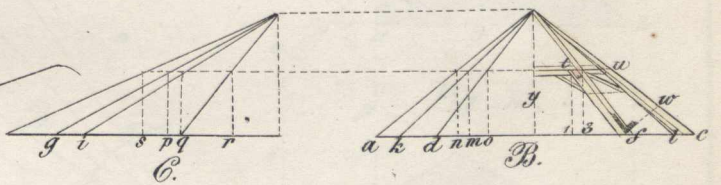
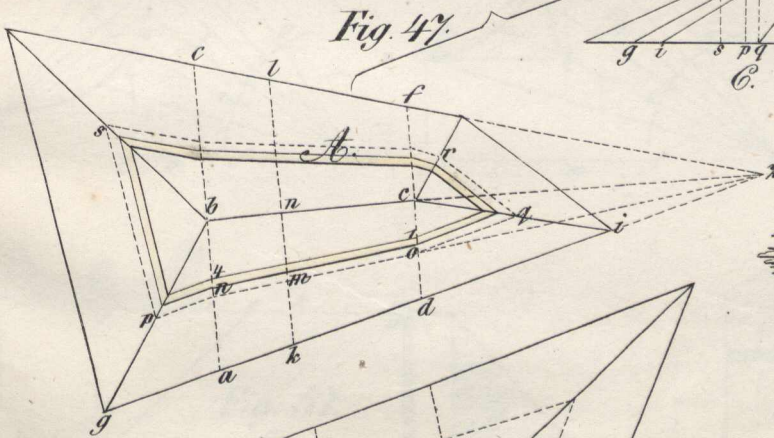
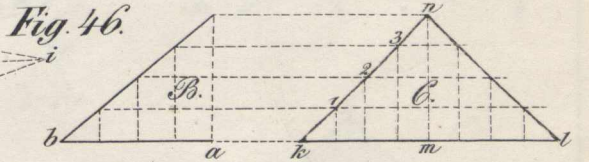
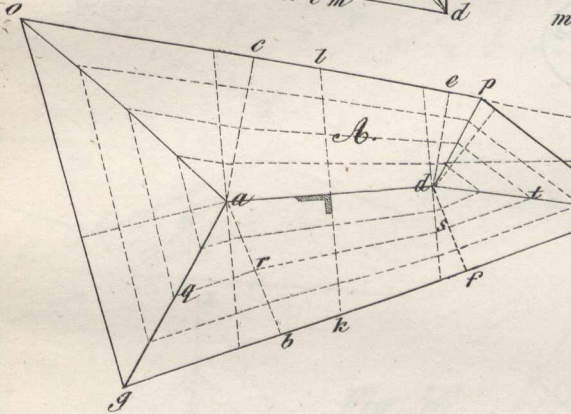
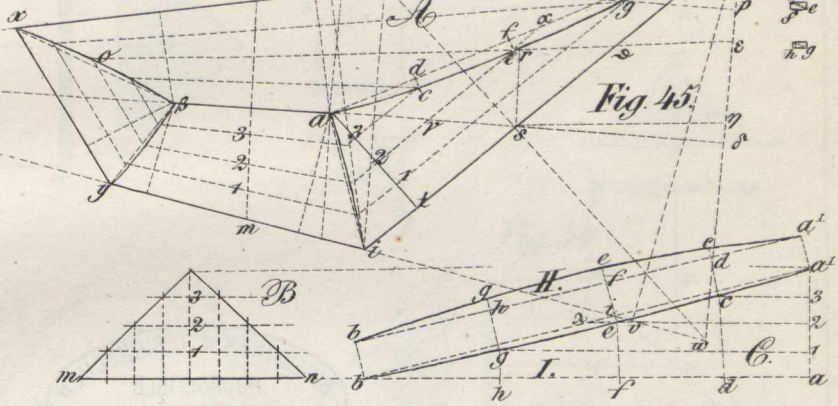
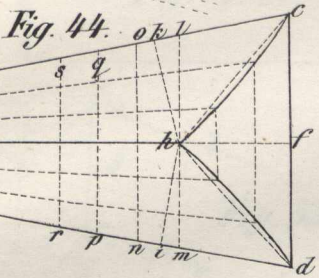
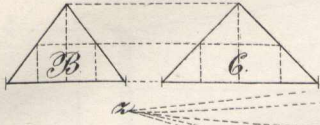
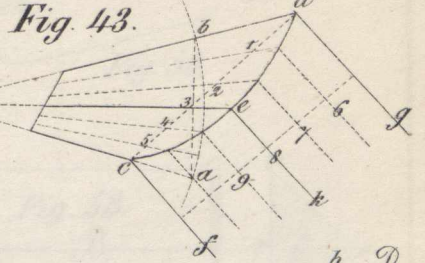
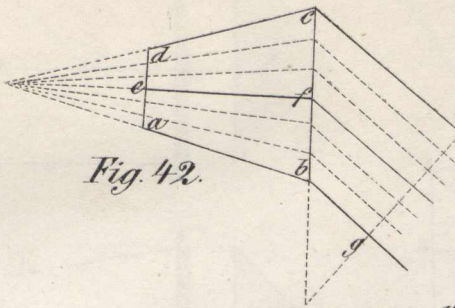
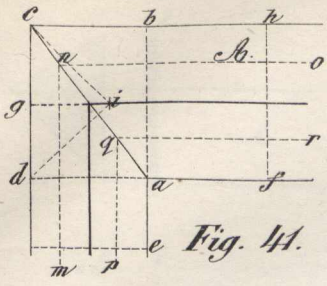



BIBLIOTHEK d. TECHNISCHEN  
HOCHSCHULE  
BRESLAU  
ABT. d. ST. u. UNIV.-BIBL.



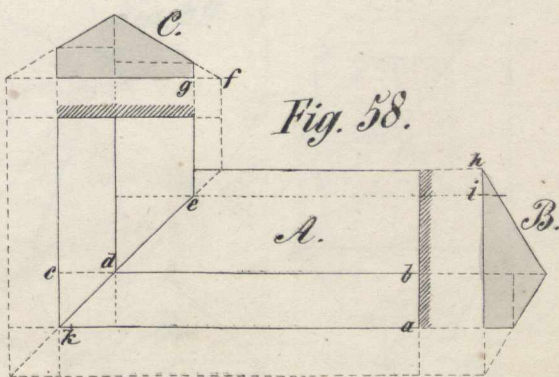
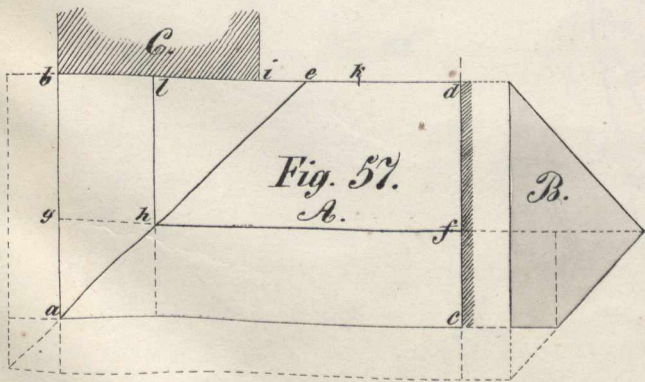
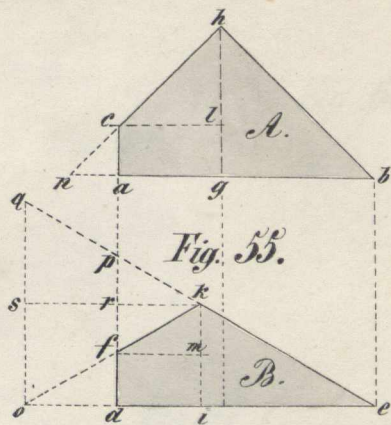
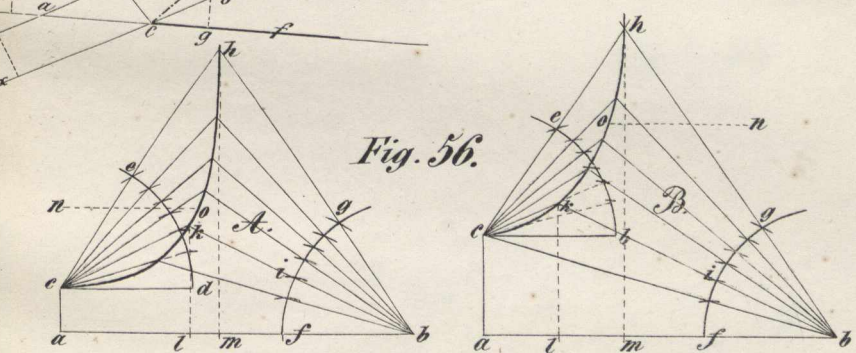
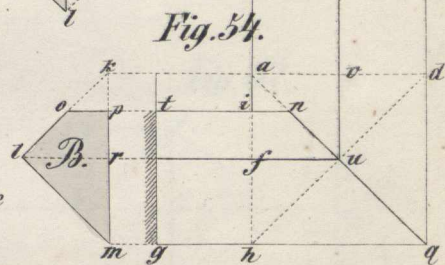
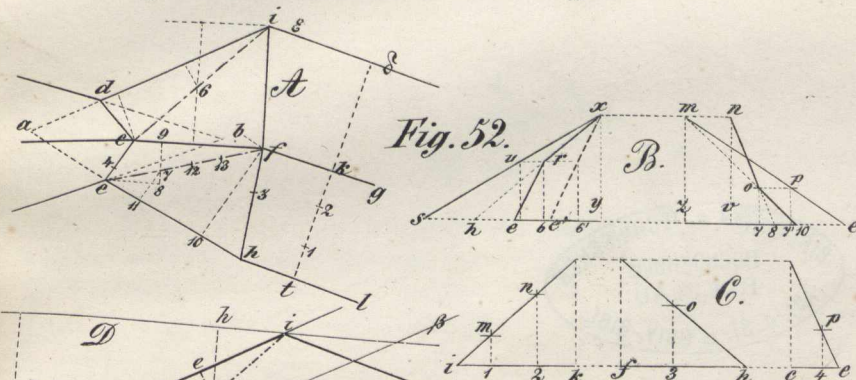
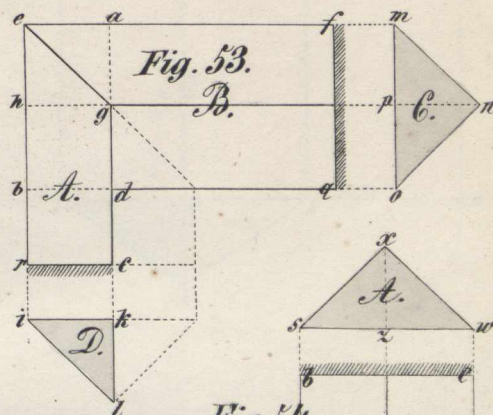
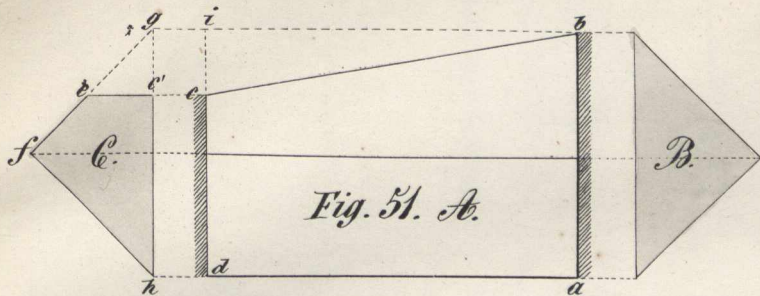
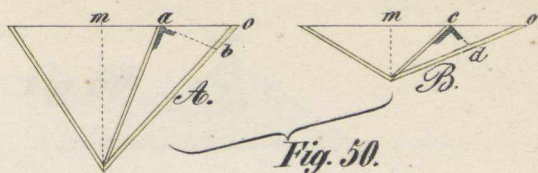
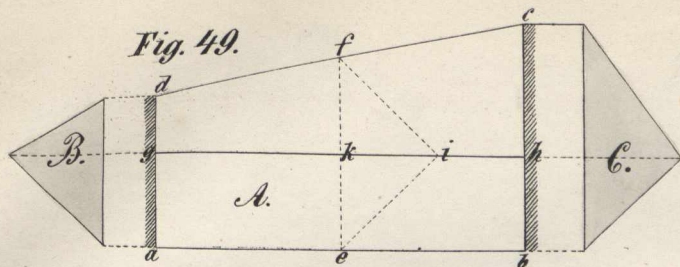



BIBLIOTHEK d. TECHNISCHEN  
HOCHSCHULE  
BRESLAU  
ABT. d. ST. u. UNIV.-BIBL.



Fig. 59.

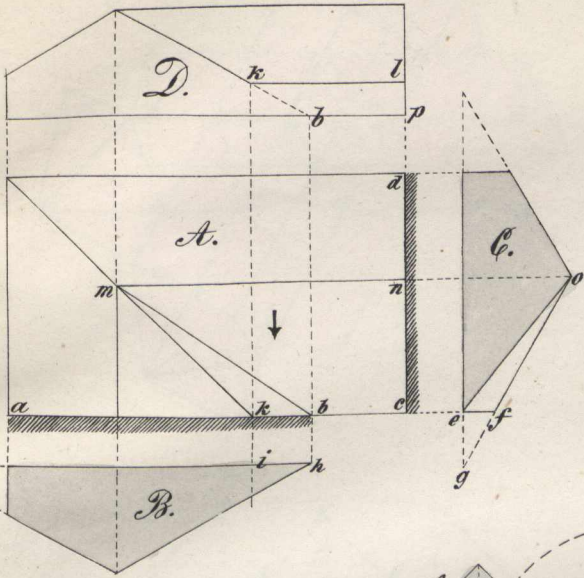

Fig. 60.

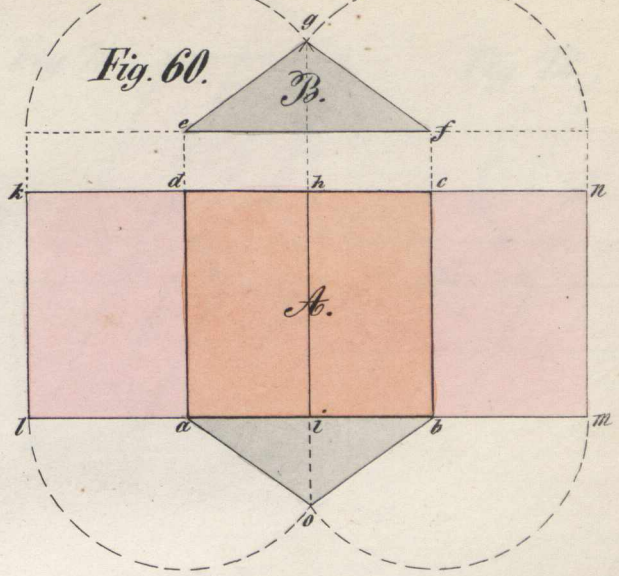

Fig. 61.

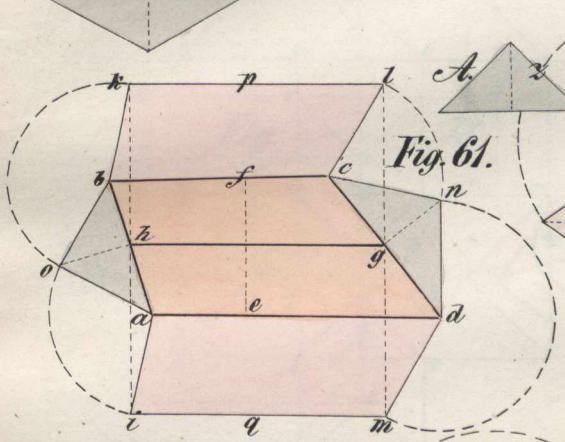

Fig. 62.

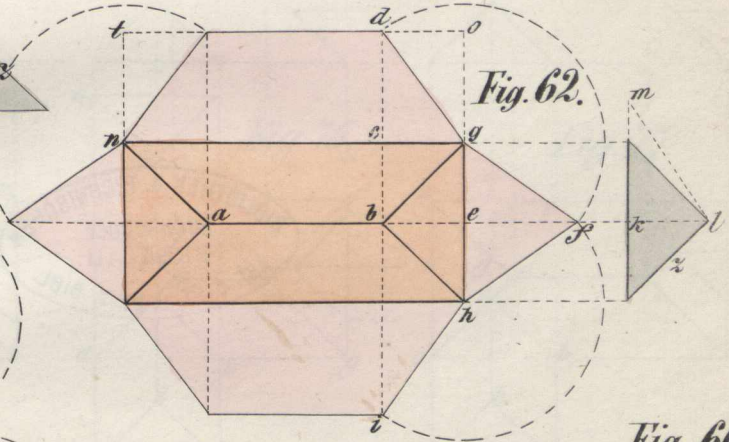

Fig. 63.

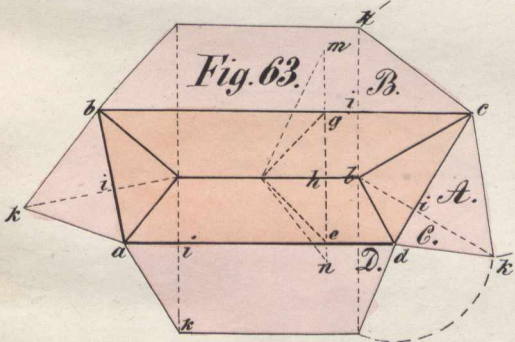

Fig. 64.

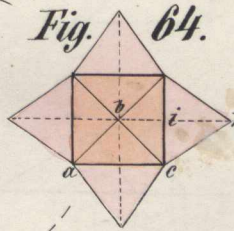

Fig. 65.

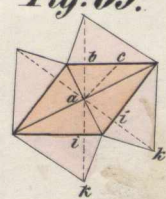

Fig. 66.

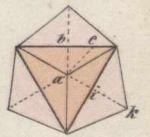

Fig. 68.

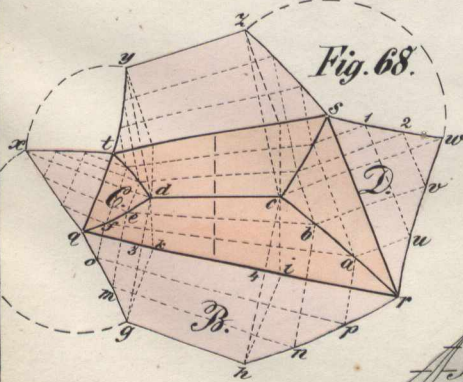

Fig. 69.

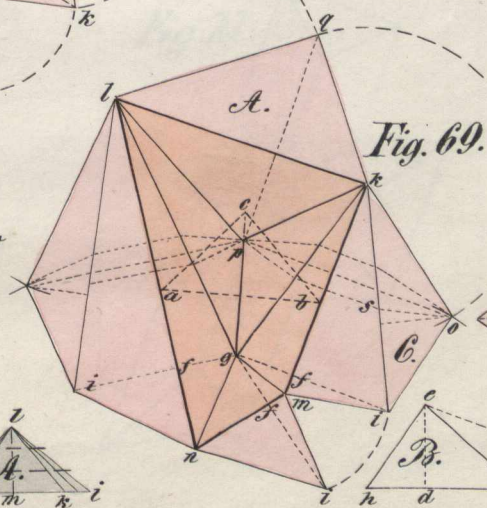
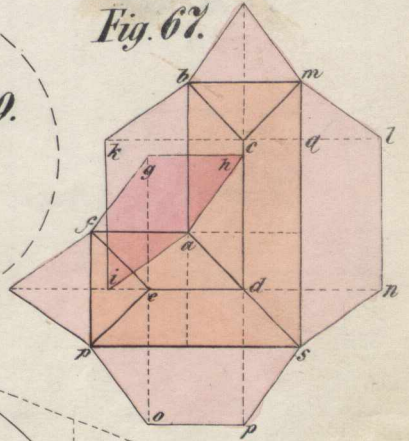

Fig. 67.





BIBLIOTHEK d. TECHNISCHEN  
HOCHSCHULE  
BRESLAU  
ABT. d. ST. u. UNIV.-BIBL.



Fig. 70.

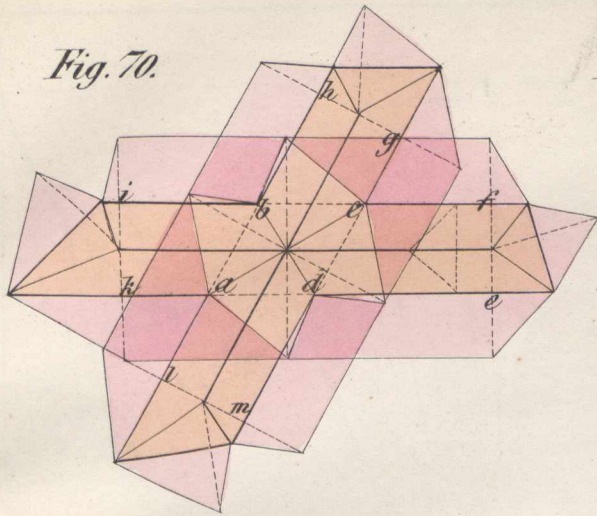

Fig. 71.

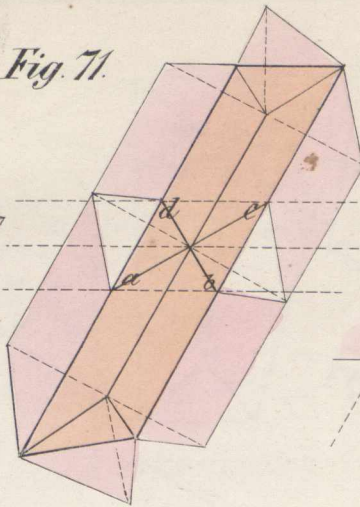
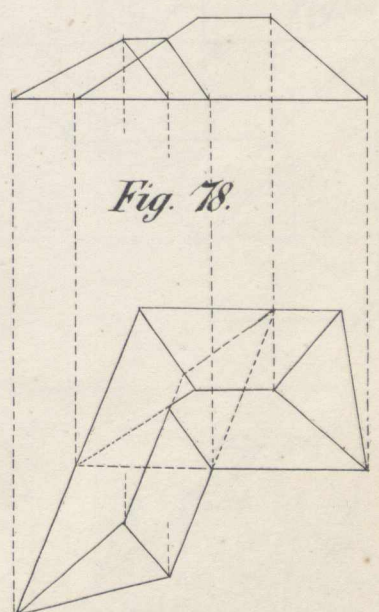
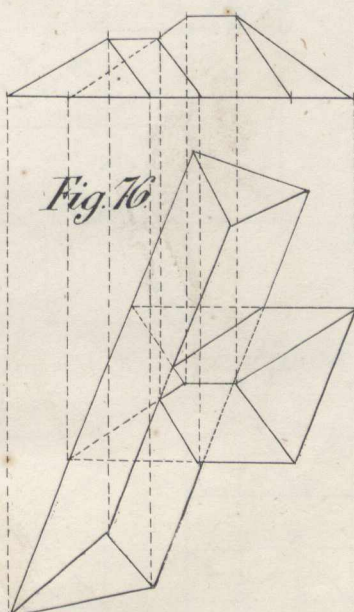
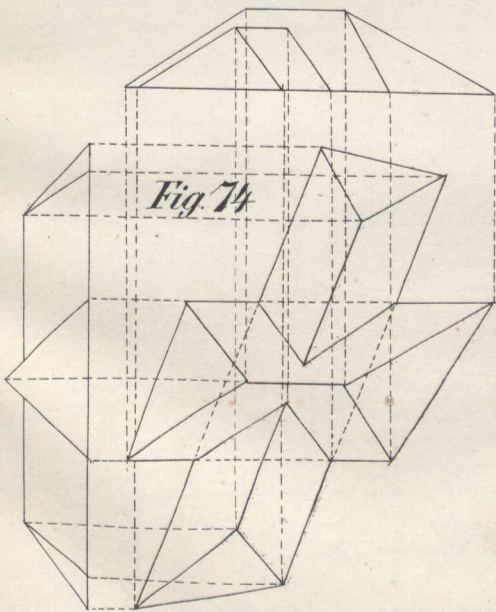
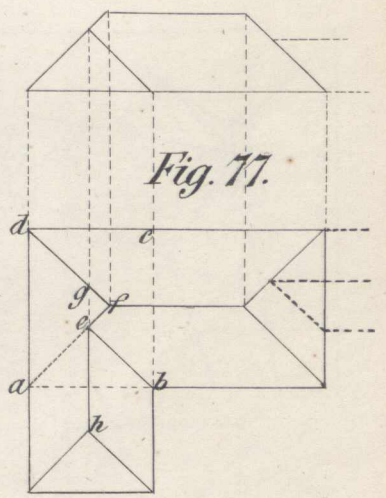
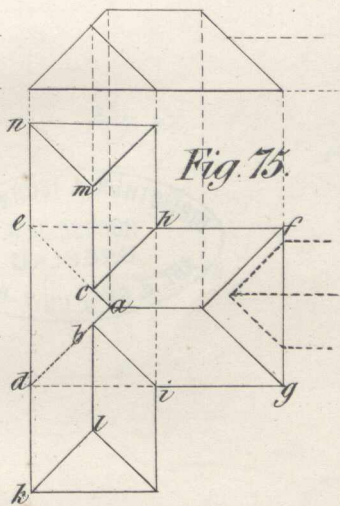
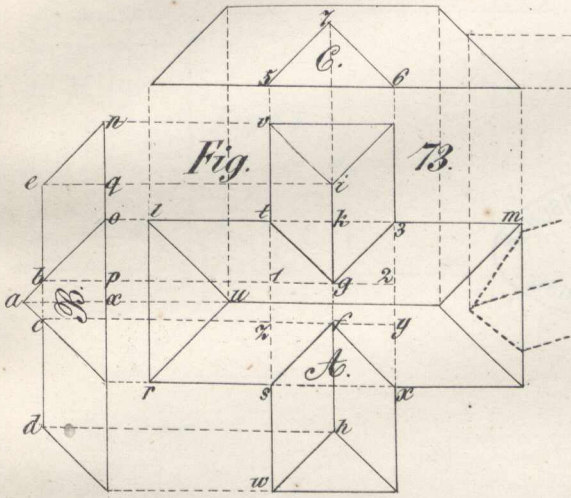
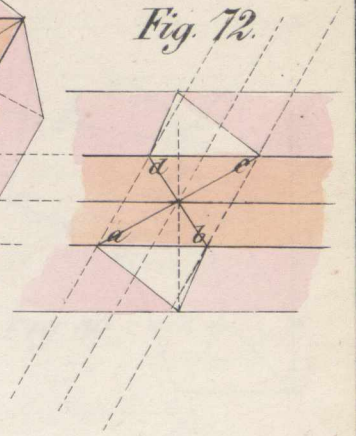

Fig. 72.





BIBLIOTHEK d. TECHNISCHEN  
HOCHSCHULE  
BRESLAU  
ABT. d. ST. u. UNIV.-BIBL.



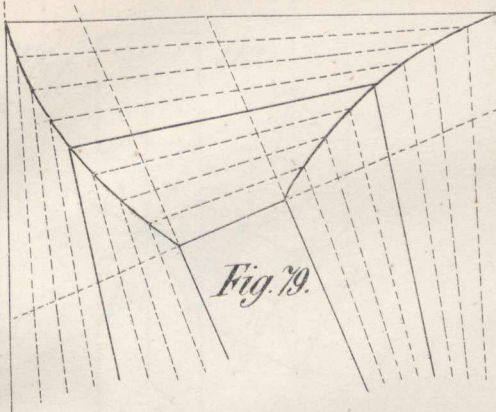

Fig. 79.

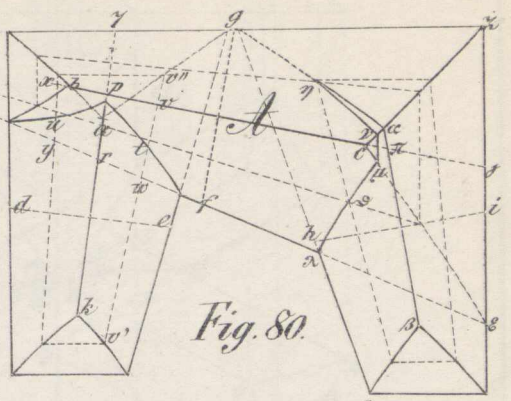
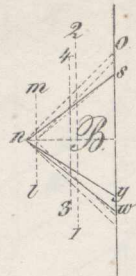

Fig. 80.

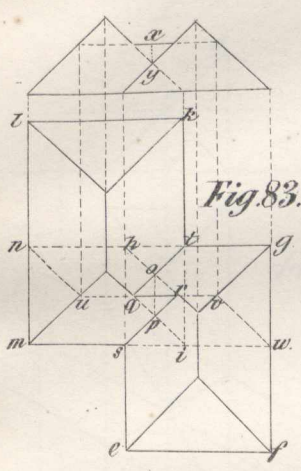
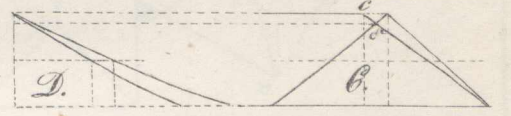

Fig. 83.

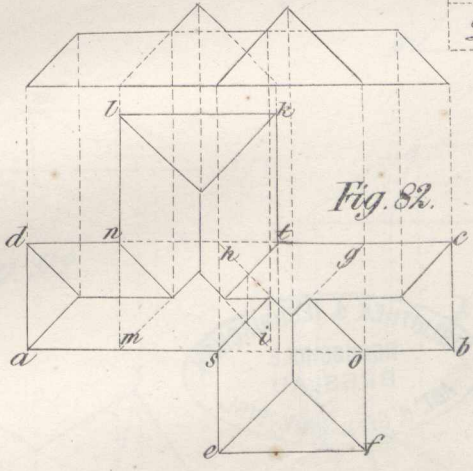

Fig. 82.

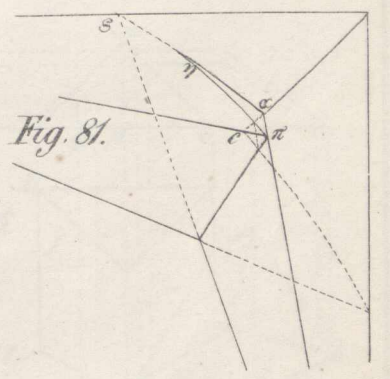

Fig. 81.

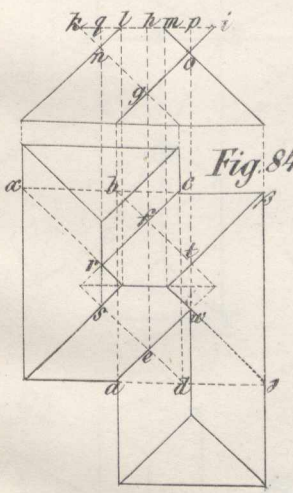

Fig. 84.

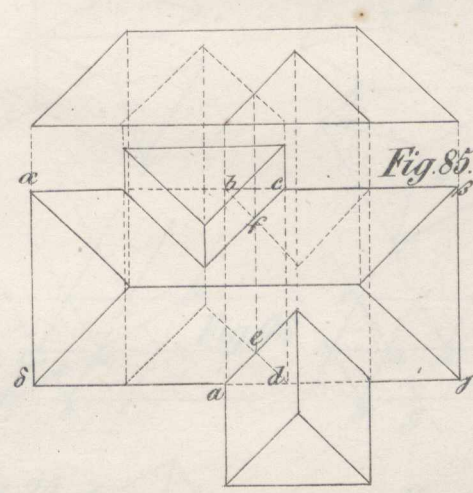

Fig. 85.

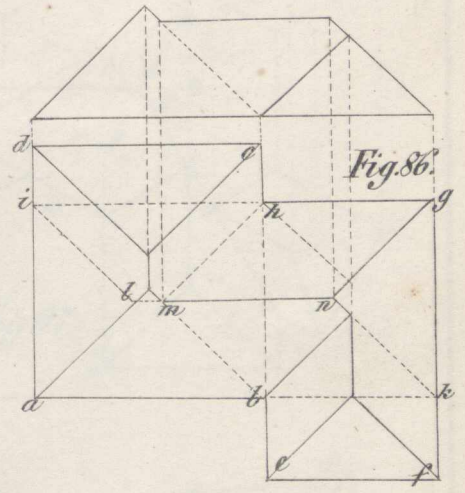

Fig. 86.

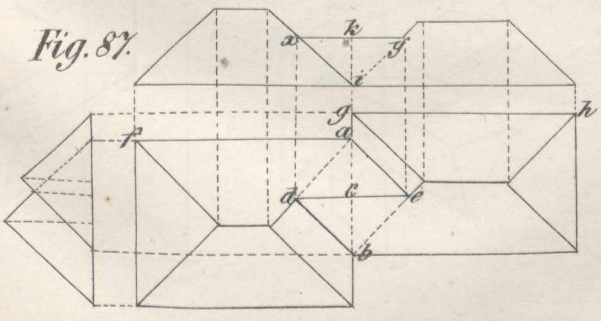

Fig. 87.

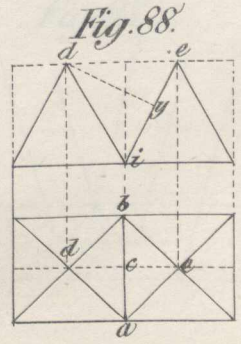

Fig. 88.

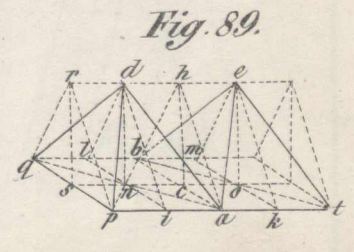

Fig. 89.



21.189

BIBLIOTHEK d. TECHNISCHEN  
HOCHSCHULE  
BRESLAU  
ABT. d. ST. u. UNIV.-BIBL.



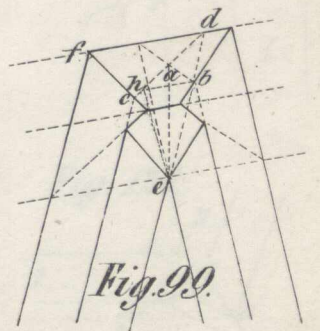
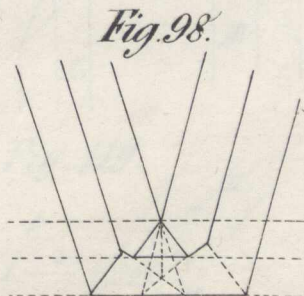
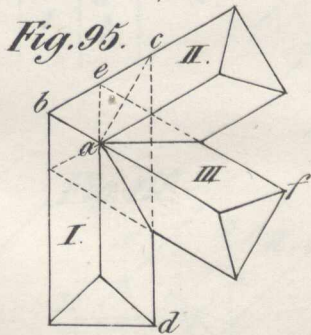
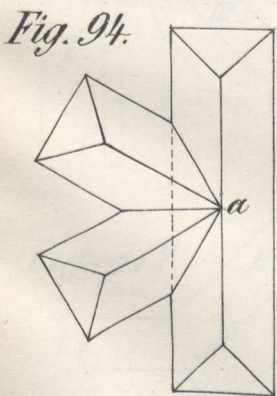
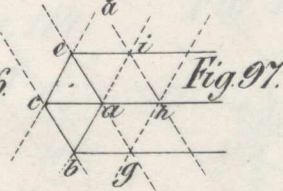
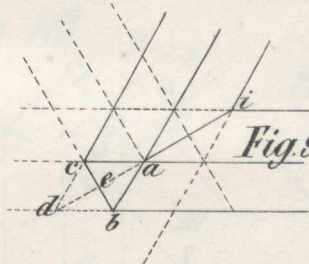
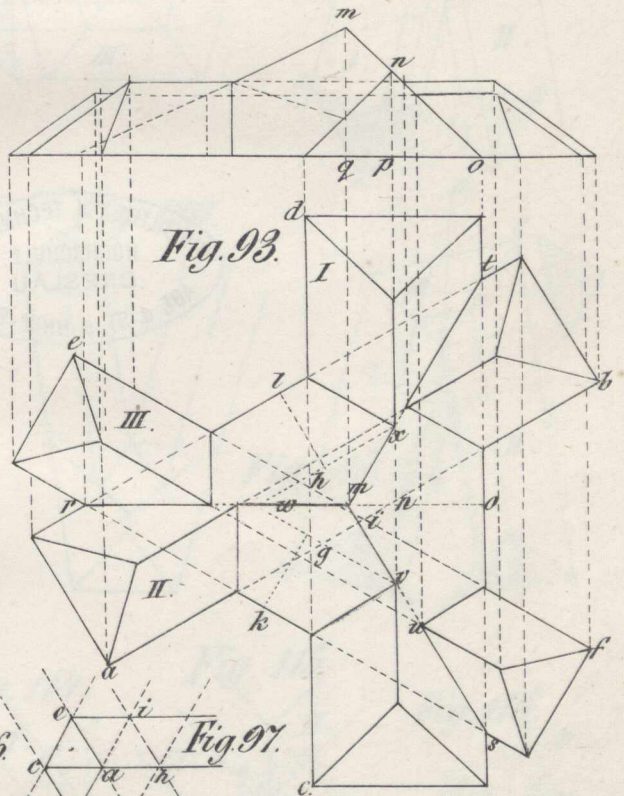
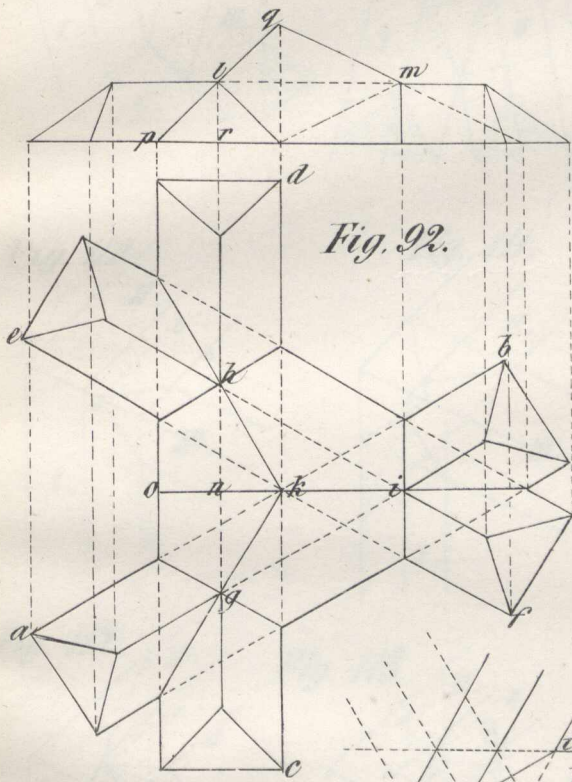
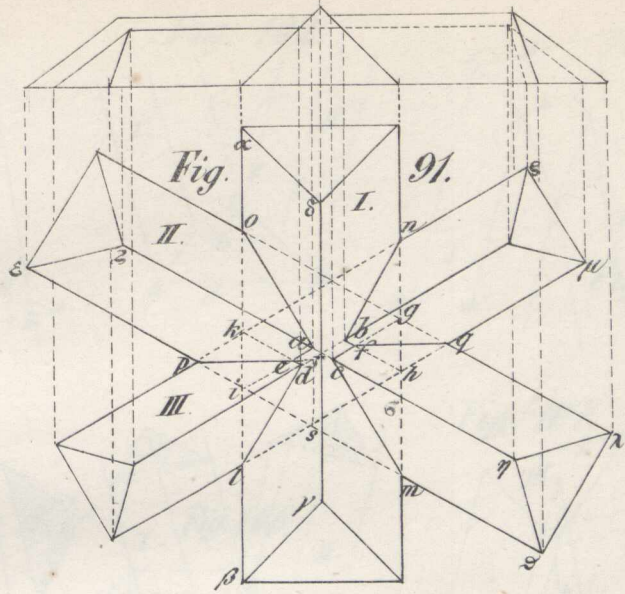
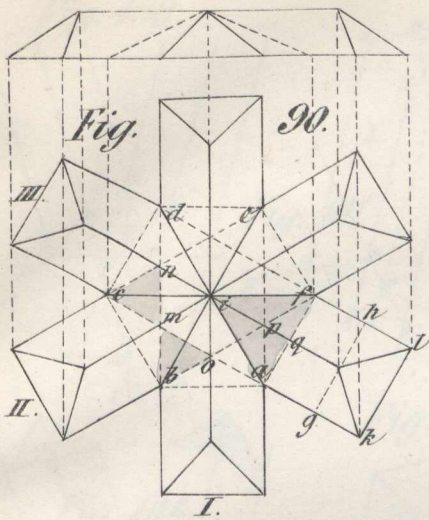



BIBLIOTHEK d. TECHNISCHEN  
HOCHSCHULE  
BRESLAU  
ABT. d. ST. u. UNIV.-BIBL.



Fig. 100.

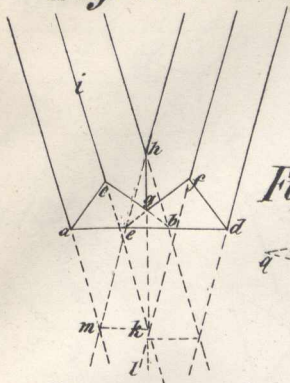

Fig. 101.

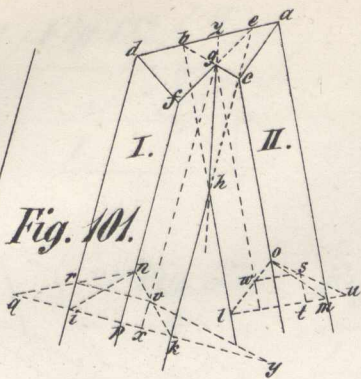

Fig. 102.

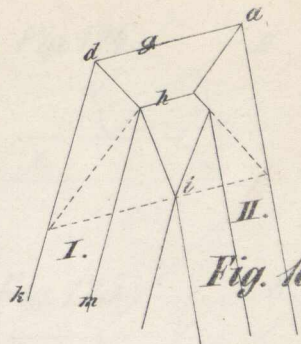
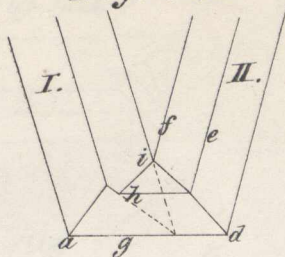

Fig. 103.

Fig. 104.

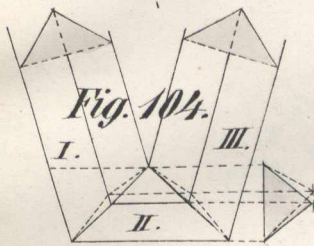

Fig. 105.

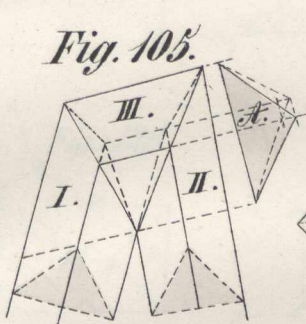

Fig. 106.

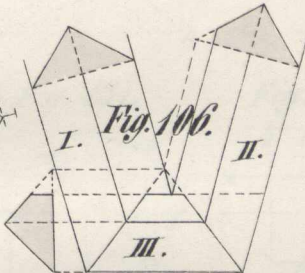

Fig. 107.

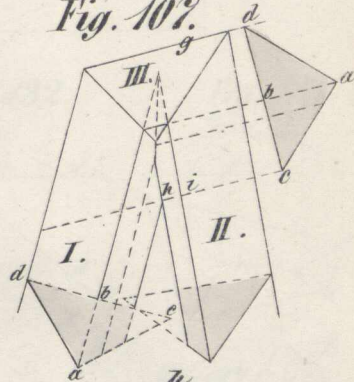

Fig. 110.

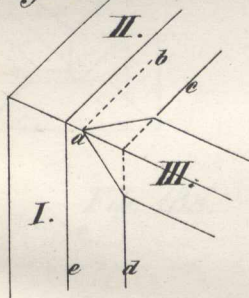

Fig. 111.

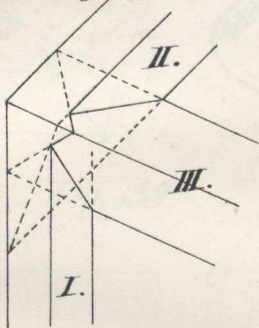

Fig. 109.

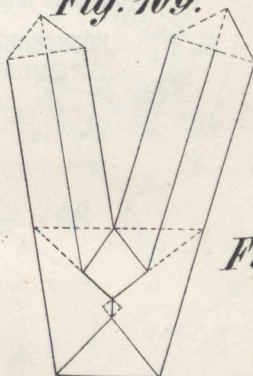

Fig. 108.

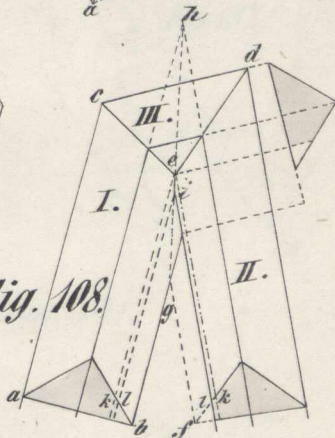

Fig. 112.

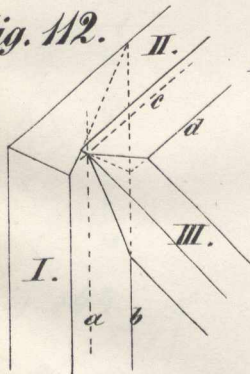

Fig. 113.

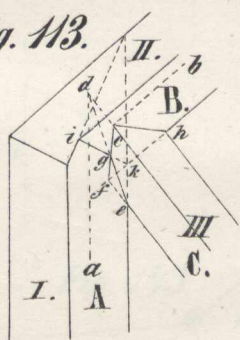

Fig. 114.

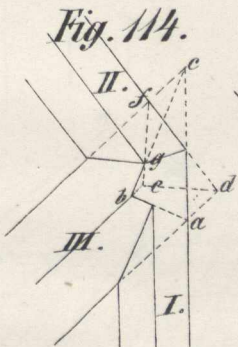

Fig. 115.

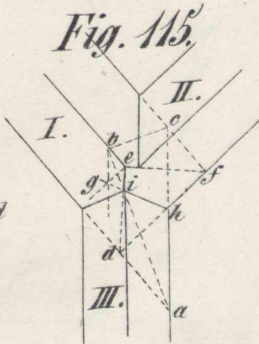

Fig. 116.

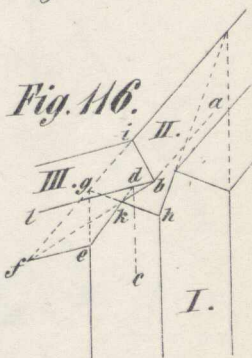

Fig. 117.

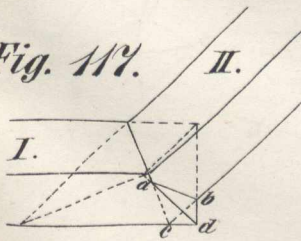

Fig. 118.

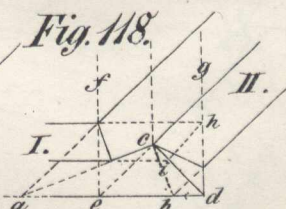

Fig. 119.

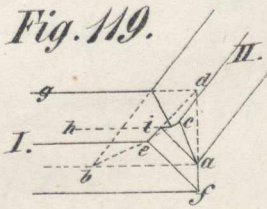
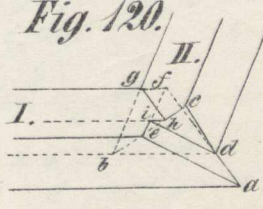

Fig. 120.





IX 76T

BIBLIOTHEK d. TECHNISCHEN  
HOCHSCHULE  
ERESLAU  
ABT. d. ET. u. UNIV.-BIBL.



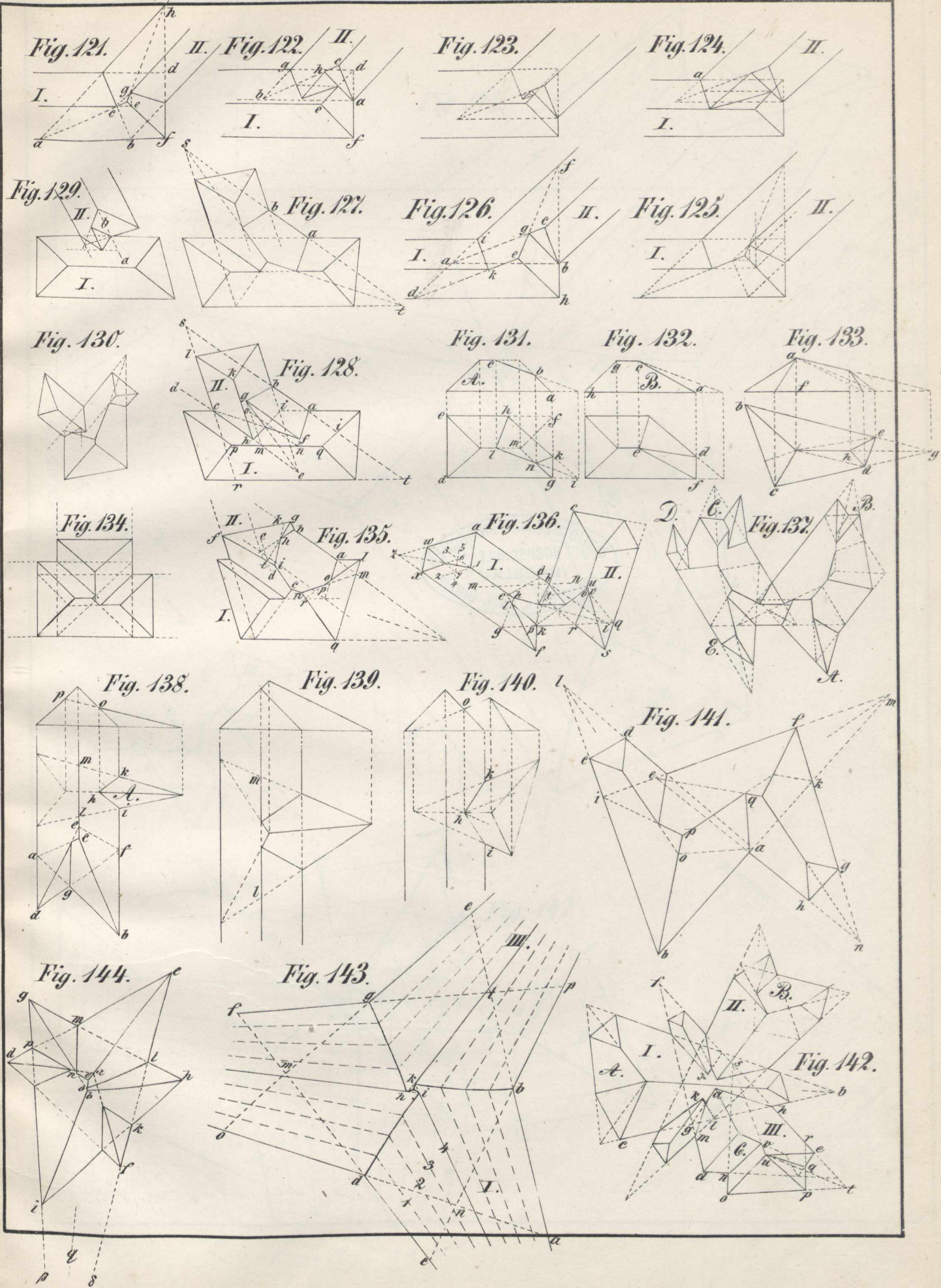



BIBLIOTHEK d. TECHNISCHEN  
HOCHSCHULE  
BRESLAU  
ABT. d. ST. u. UNIV.-BIBL.



Fig. 145.

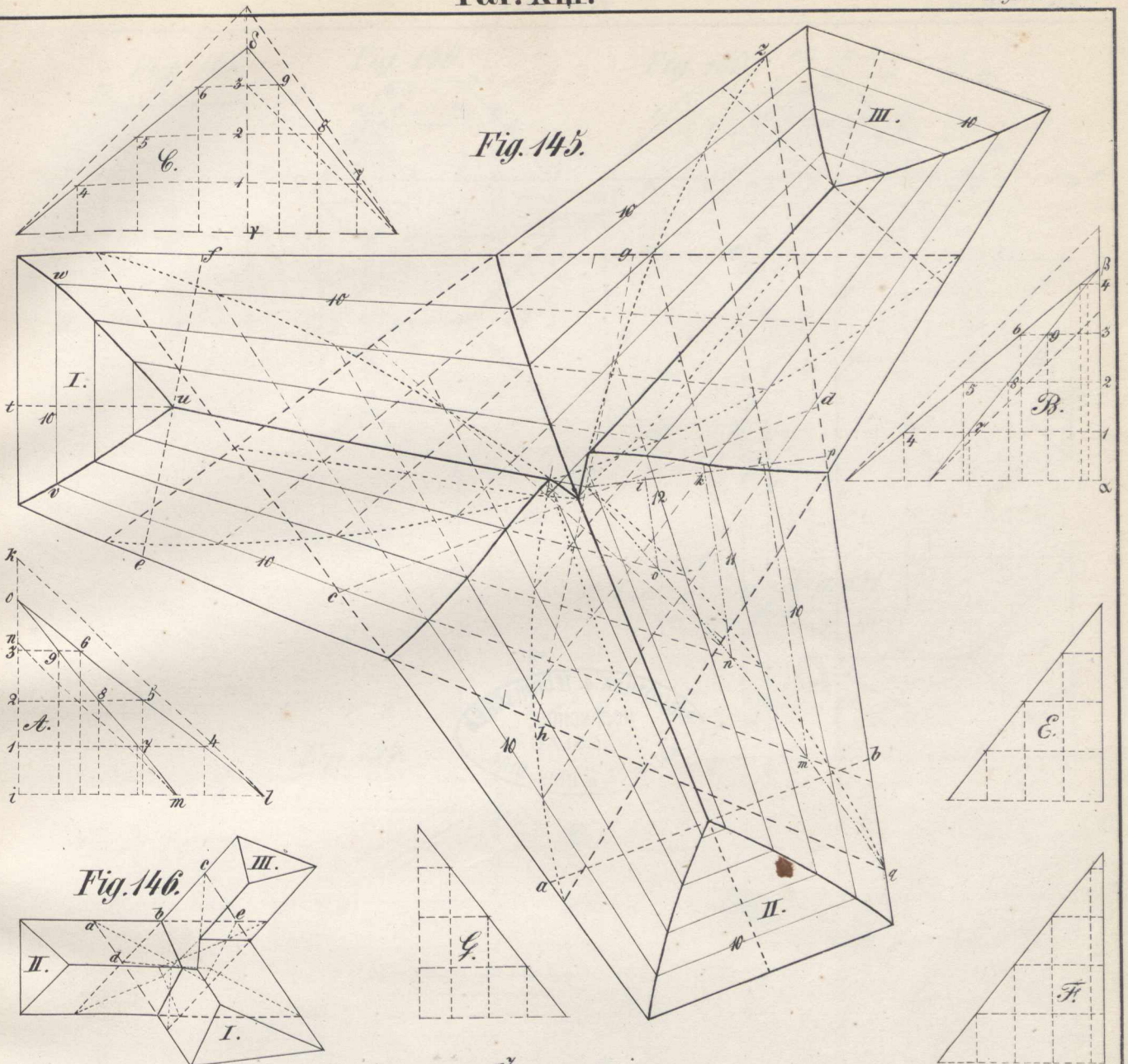

Fig. 146.

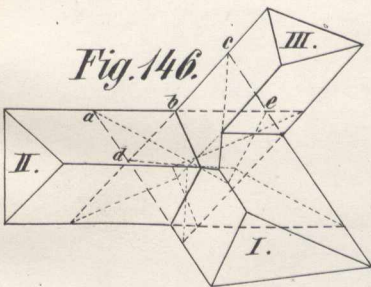
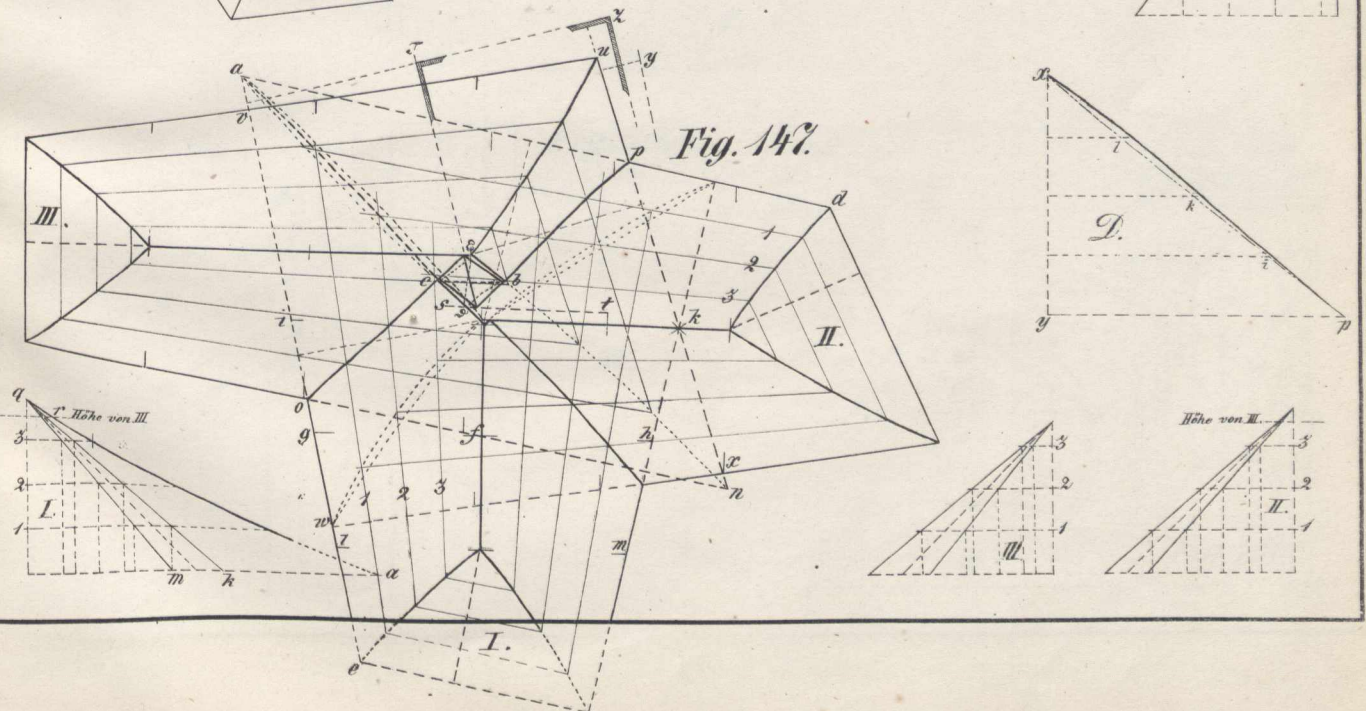

Fig. 147.





BIBLIOTHEK d. TECHNISCHEN  
HOCHSCHULE  
BRESLAU  
ABT. d. ST. u. UNIV.-BIBL.



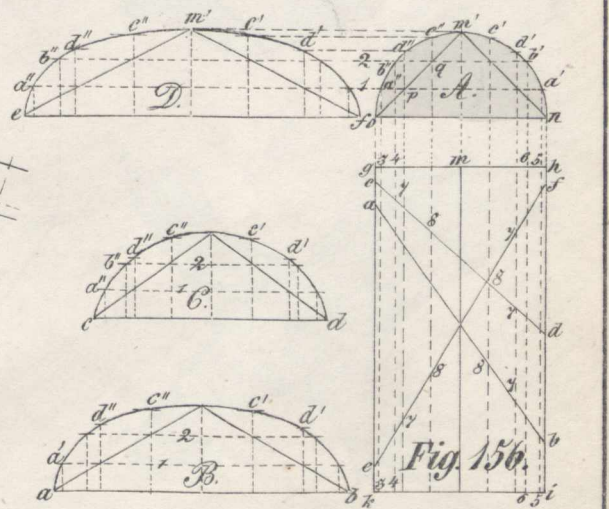
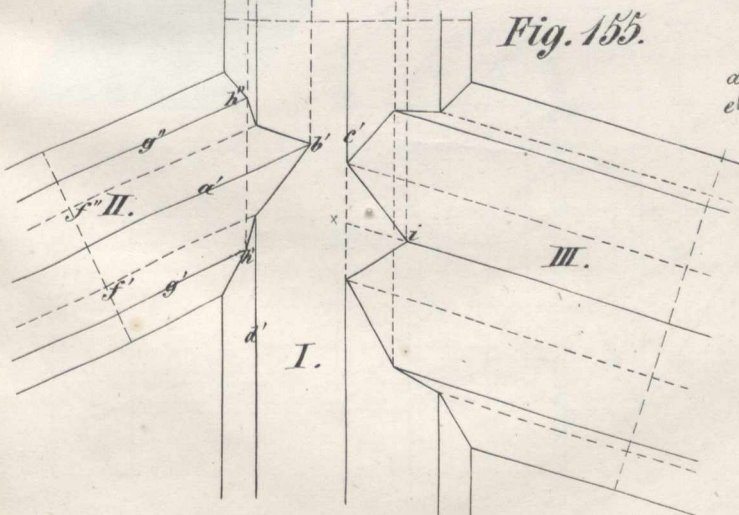
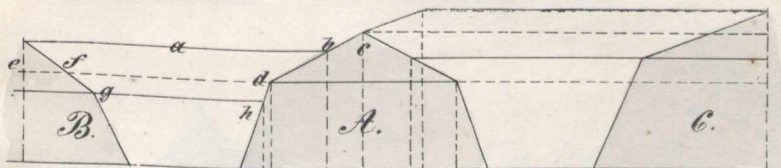
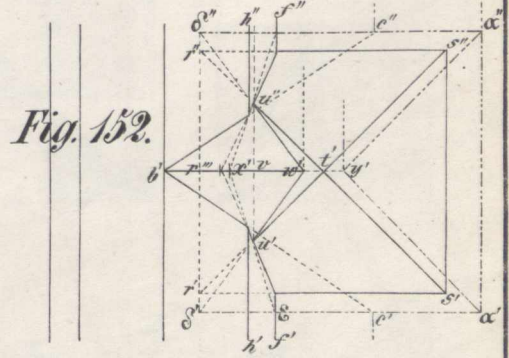
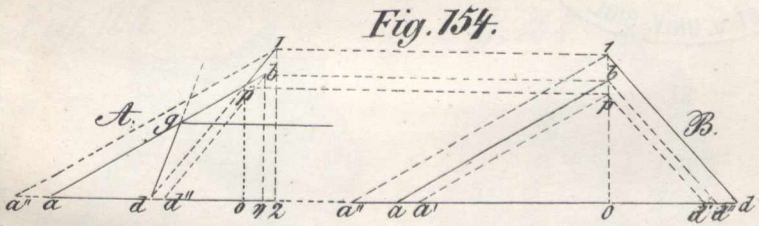
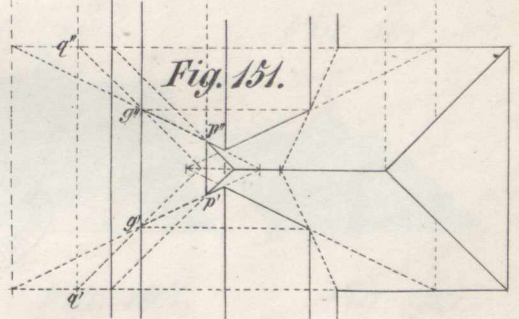
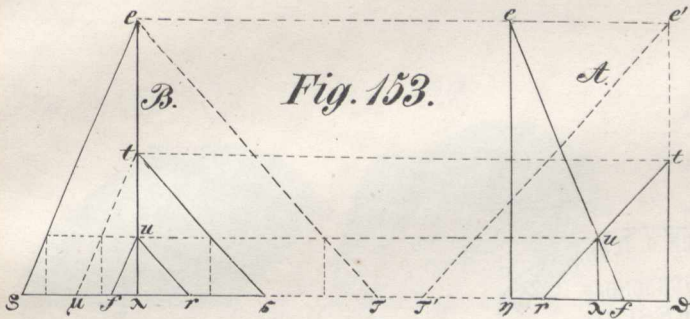
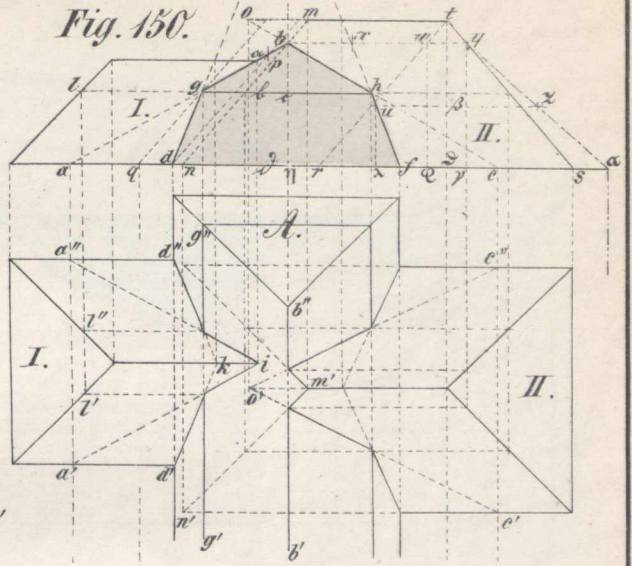
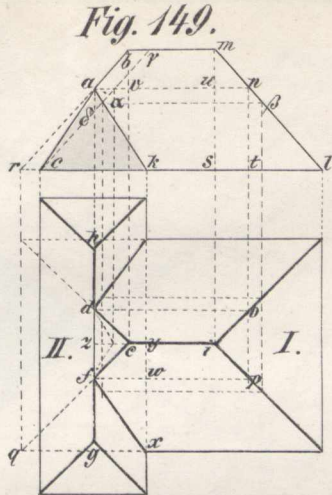
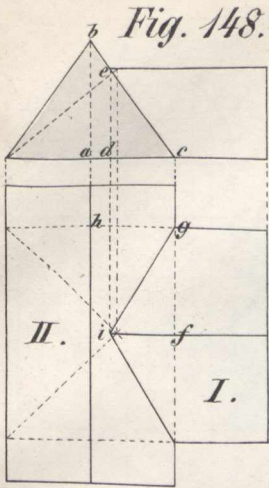



BIBLIOTHEK d. TECHNISCHEN  
HOCHSCHULE  
BRESLAU  
ABT. d. ST. u. UNIV.-BIBL.



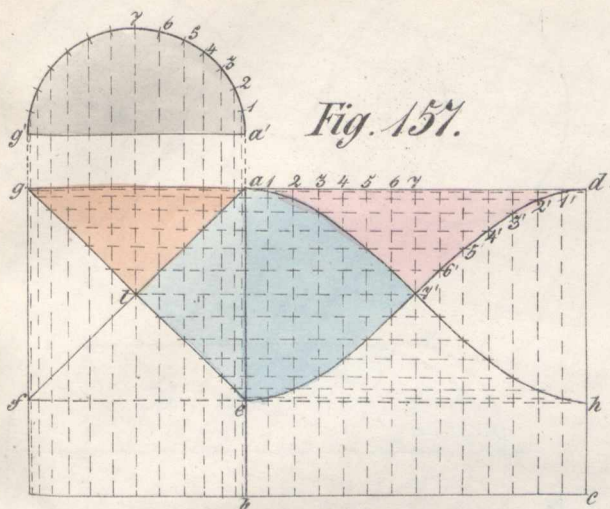

Fig. 157.

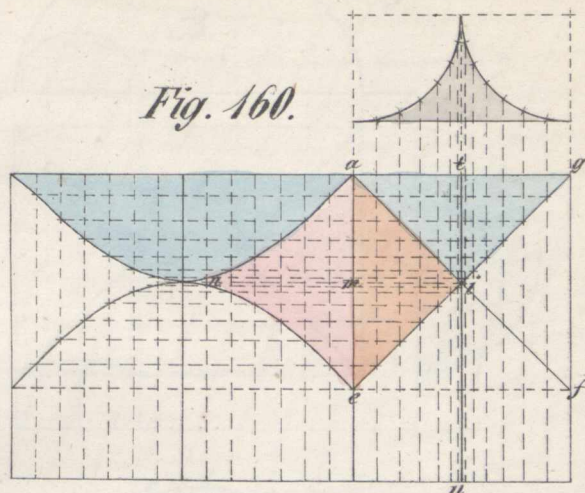

Fig. 160.

Fig. 158.

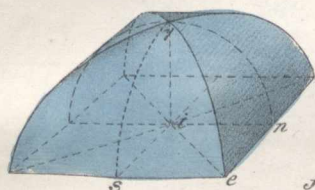

Fig. 159.

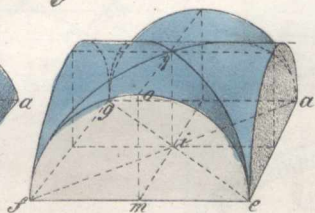

Fig. 162.

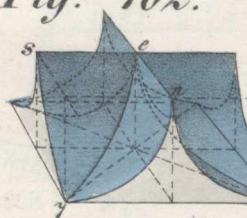

Fig. 161.

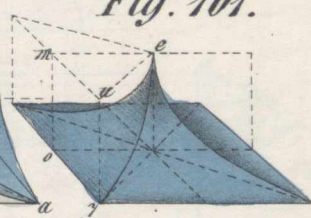

Fig. 166.

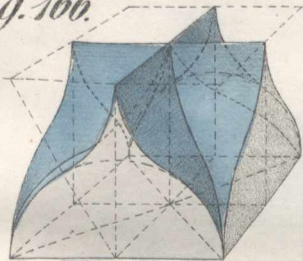

Fig. 164.

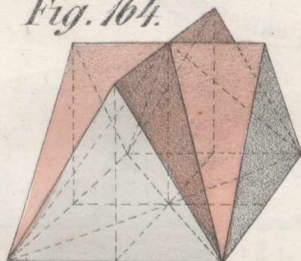

Fig. 163.

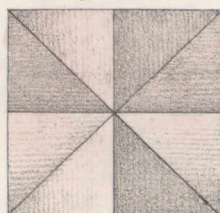

Fig. 165.

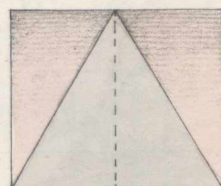

Fig. 167.

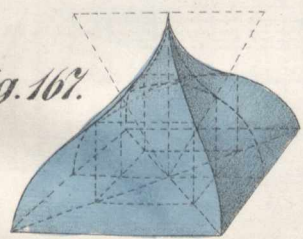
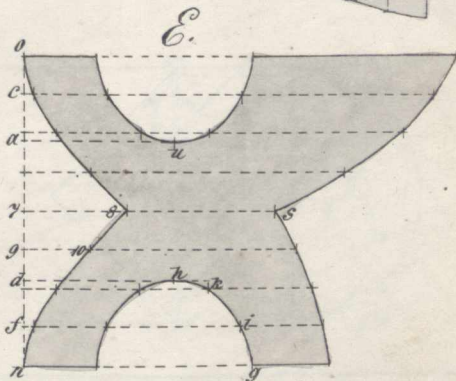
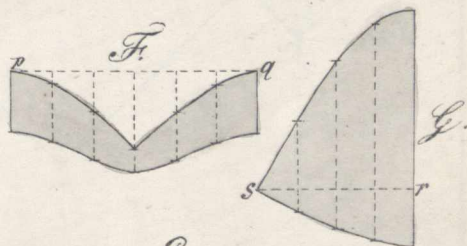
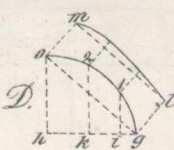
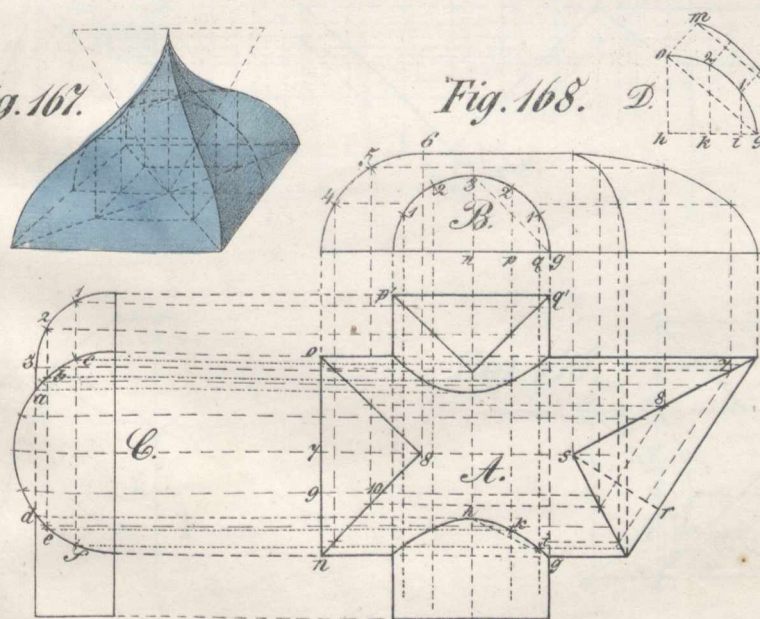

Fig. 168.





BIBLIOTHEK d. TECHNISCHEN  
HOCHSCHULE  
BRESLAU  
ABT. d. ST. u. UNIV.-BIBL.



Fig. 169.

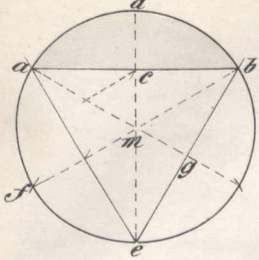

Fig. 170.

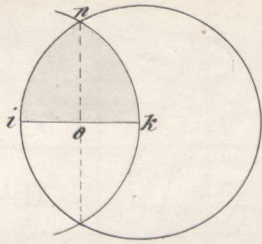

Fig. 171.

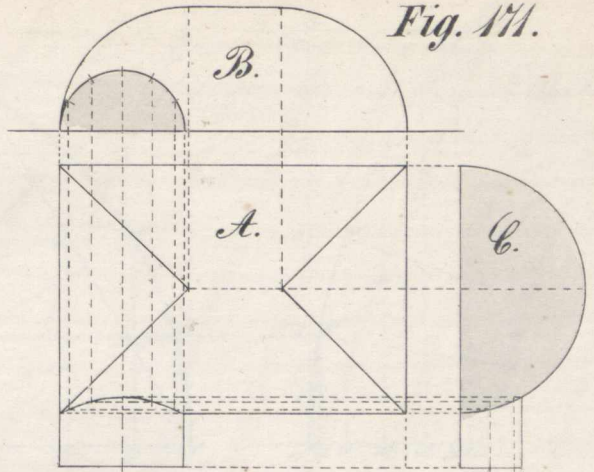

Fig. 172.

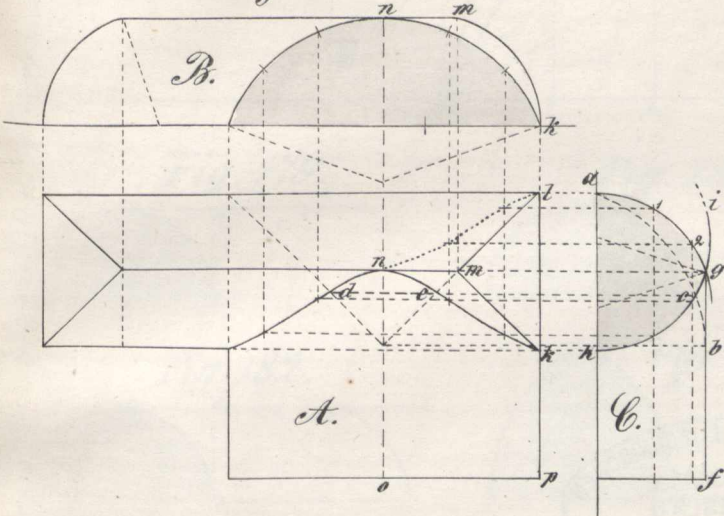

Fig. 173.

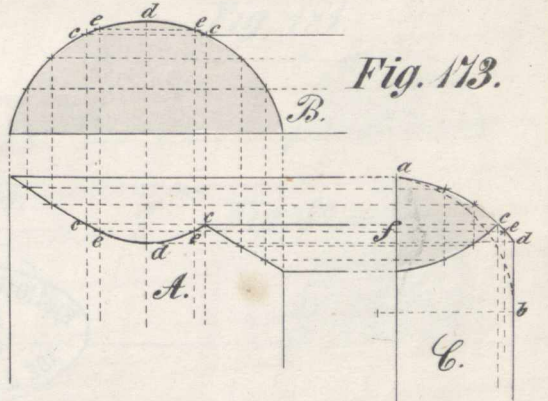

Fig. 174.

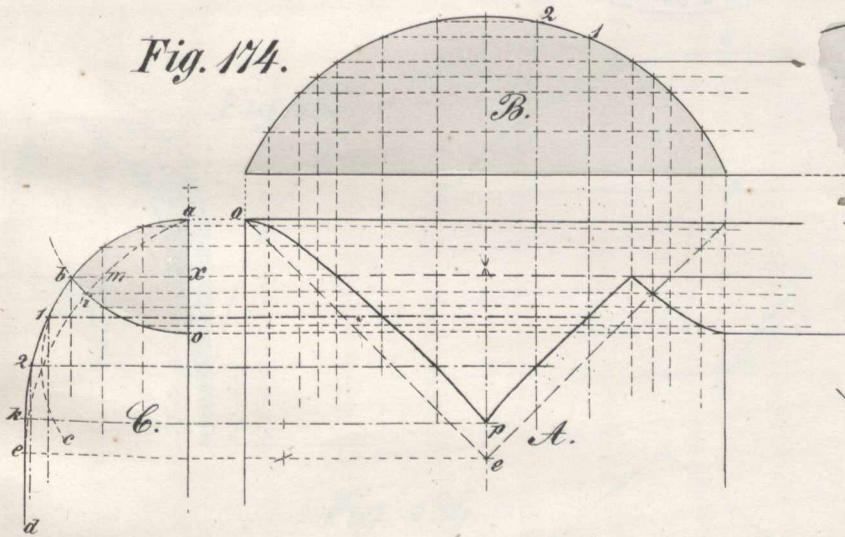

Fig. 175.

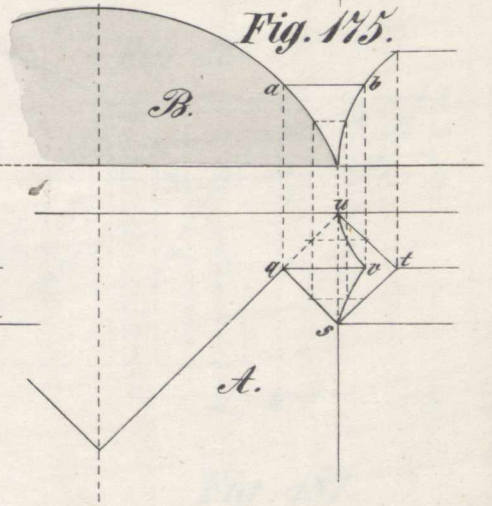
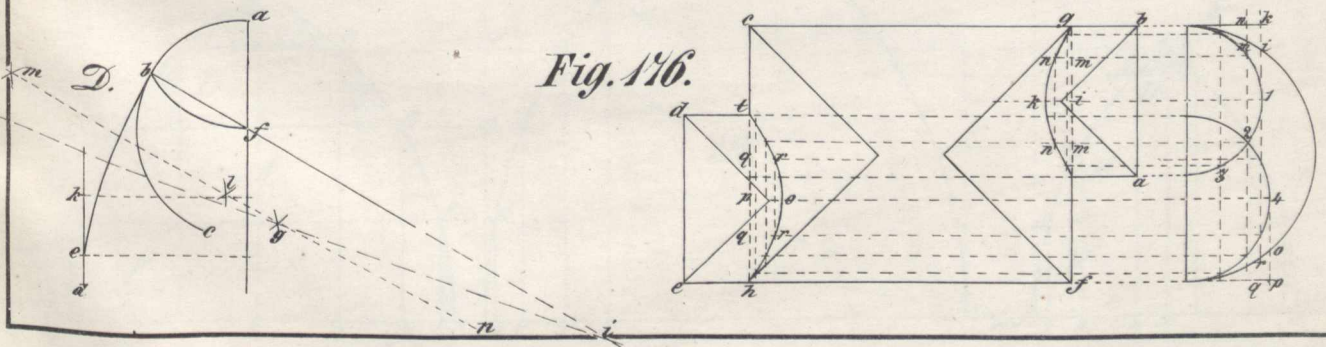

Fig. 176.





BIBLIOTHEK d. TECHNISCHEN  
HOCHSCHULE  
BRESLAU  
ABT. d. ST. u. UNIV.-BIBL.



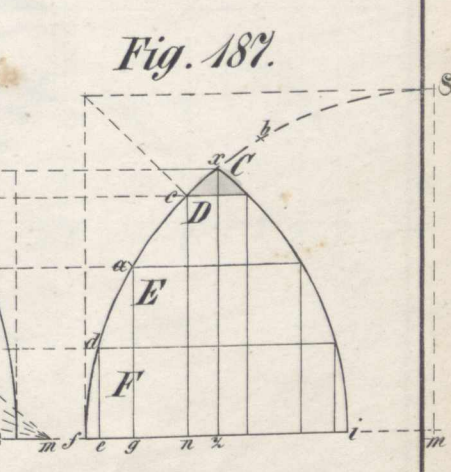
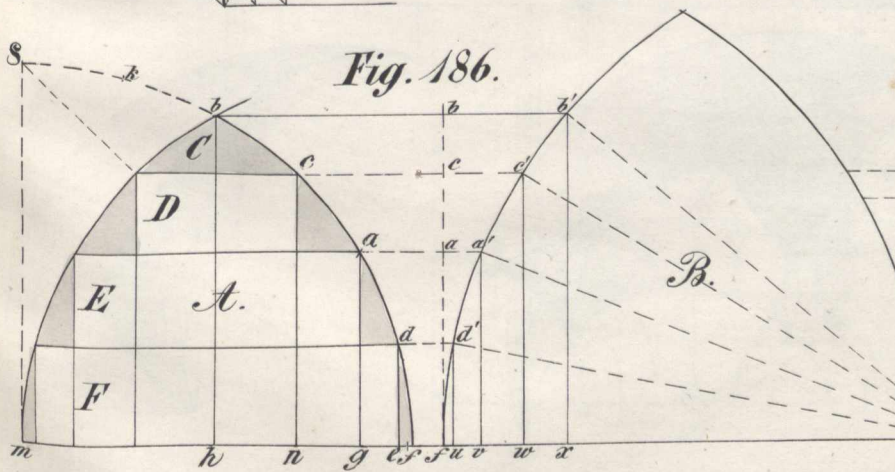
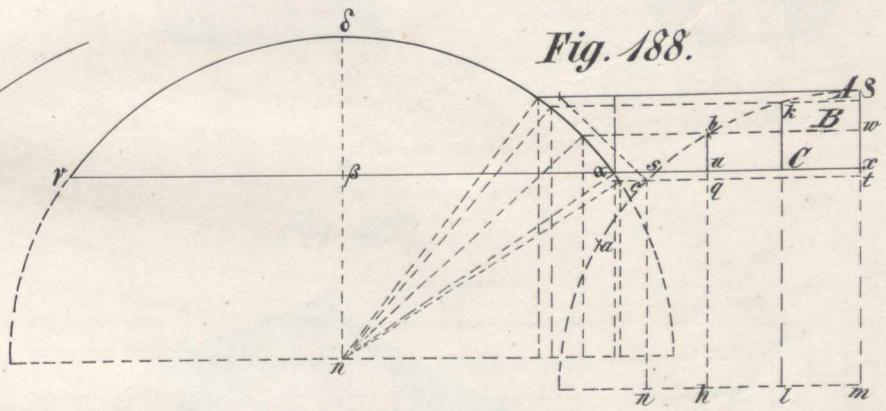
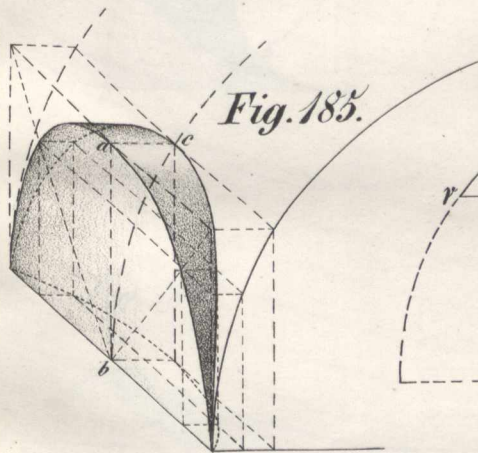
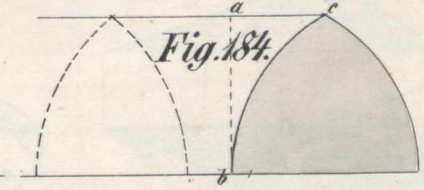
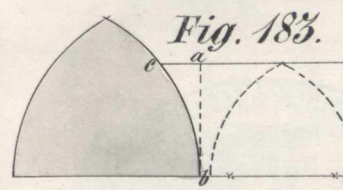
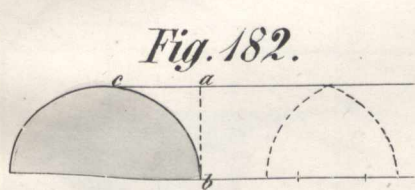
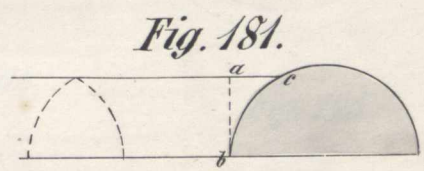
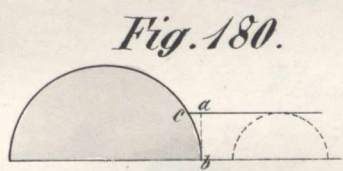
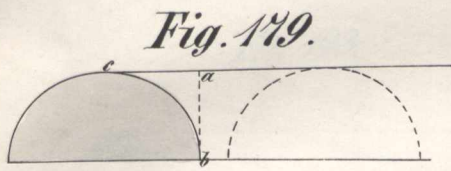
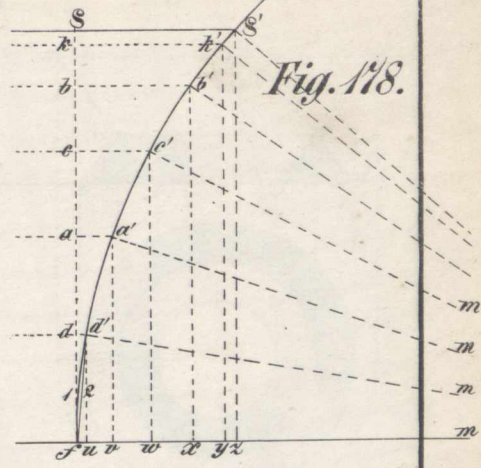
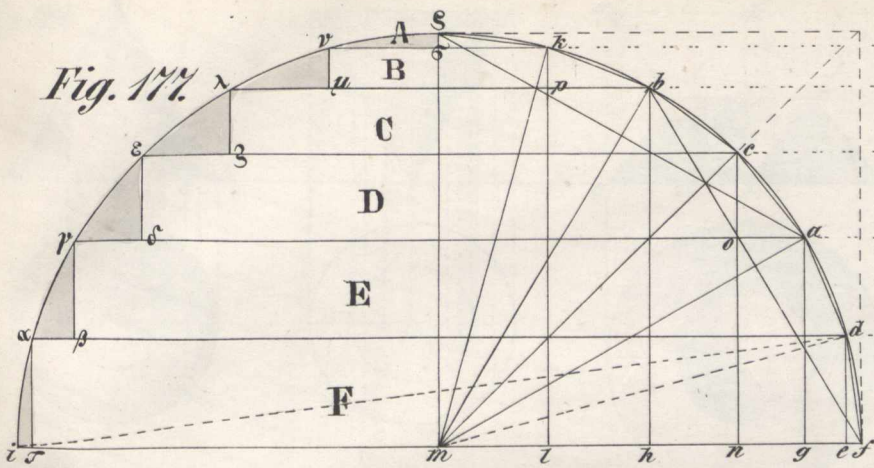



BIBLIOTHEK d. TECHNISCHEN  
HOCHSCHULE  
BRESLAU  
ABT. d. ST. u. UNIV.-BIBL.



Fig. 189.

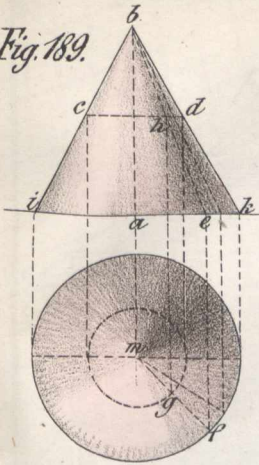

Fig. 190.

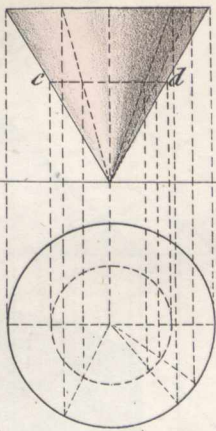

Fig. 191.

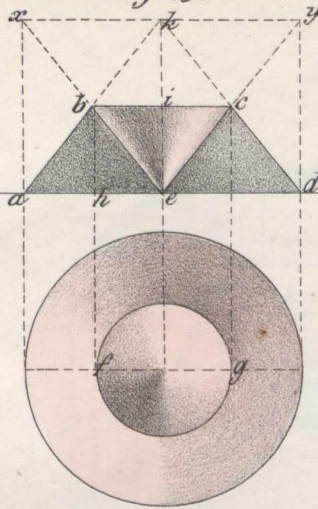

Fig. 192.

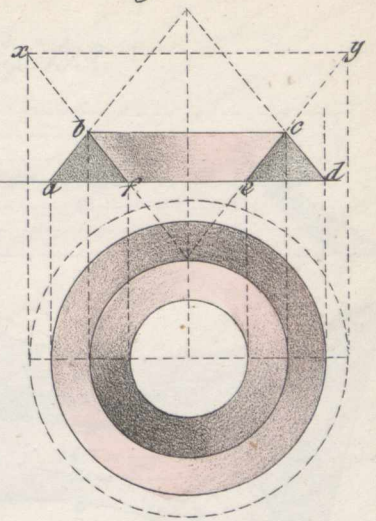

Fig. 193.

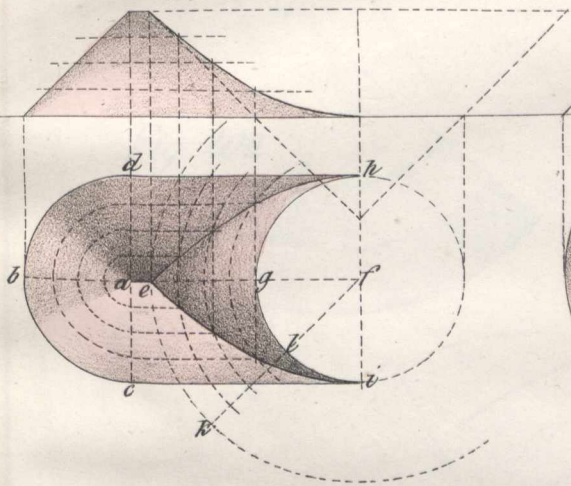

Fig. 194.

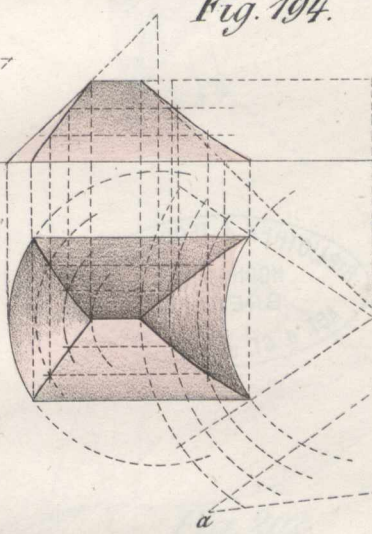

Fig. 195.

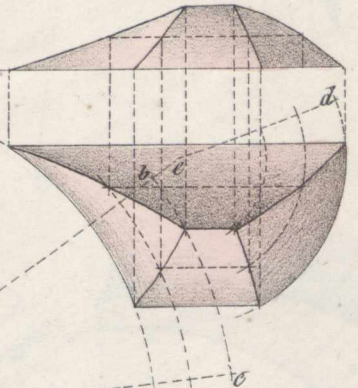

Fig. 196.

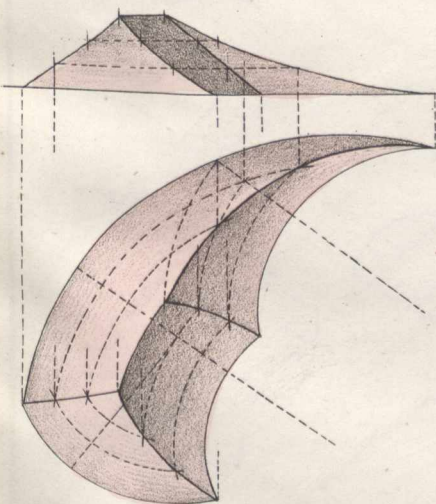
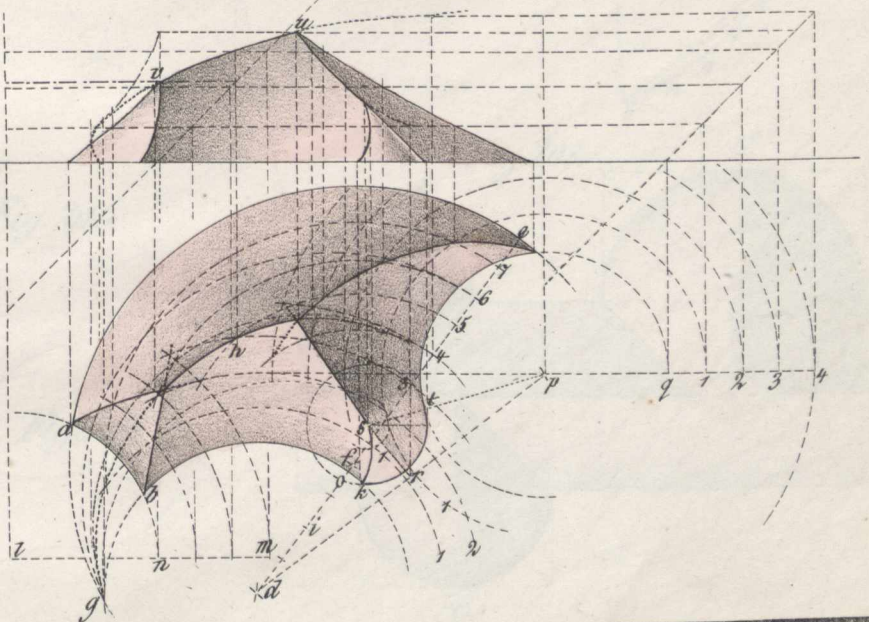

Fig. 197.





BIBLIOTHEK d. TECHNISCHEN  
HOCHSCHULE  
BRESLAU  
ABT. d. ST. u. UNIV.-BIBL.



Fig. 198.

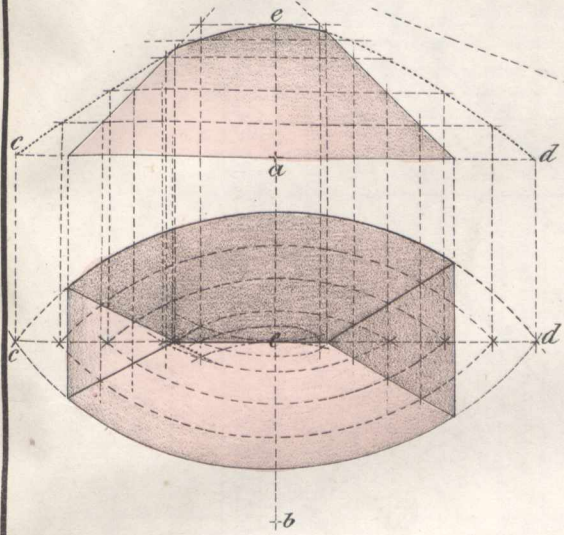

Fig. 199.

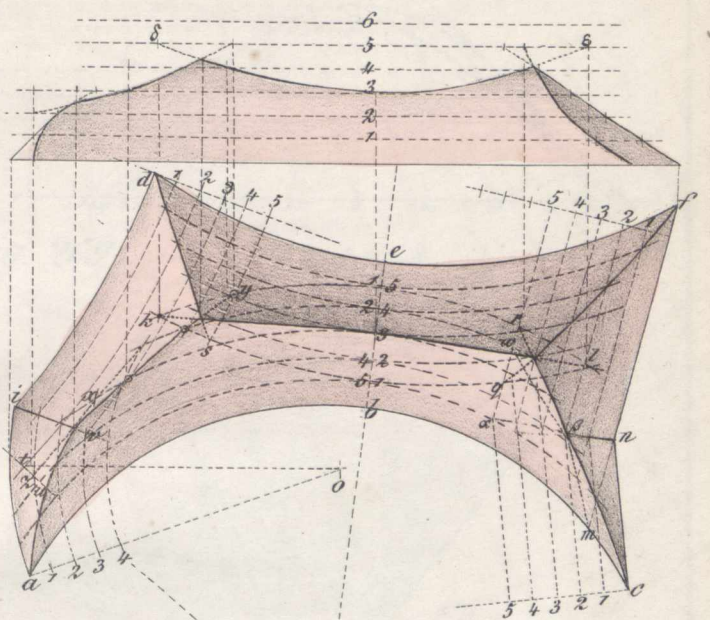

Fig. 200.

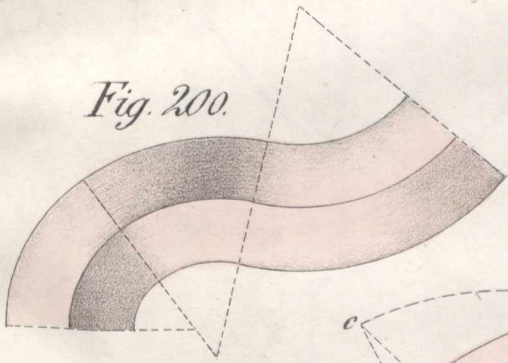

Fig. 201.

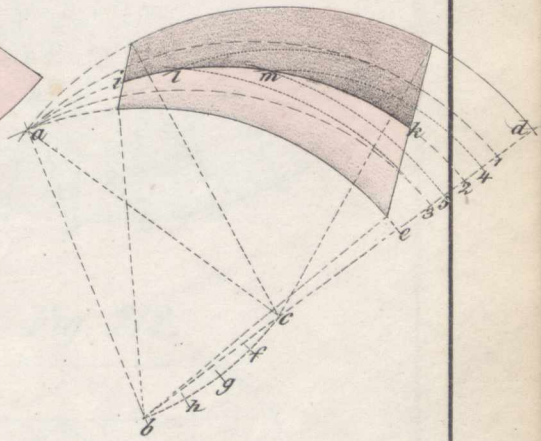

Fig. 203.



Fig. 202.

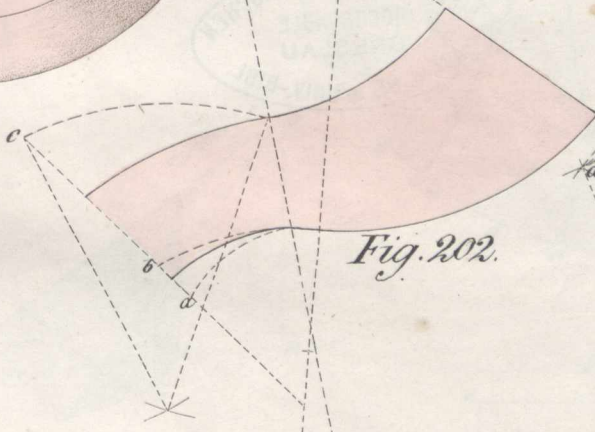

Fig. 204.



Fig. 206.



Fig. 205.

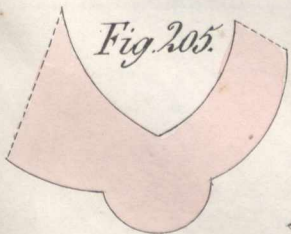

Fig. 207.

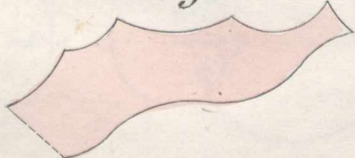
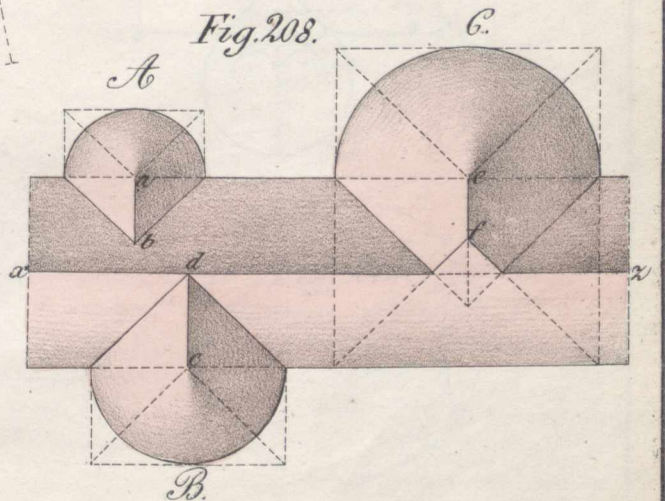

Fig. 208.





BIBLIOTHEK d. TECHNISCHEN  
HOCHSCHULE  
BRESLAU  
ABT. d. ST. u. UNIV.-BIBL.



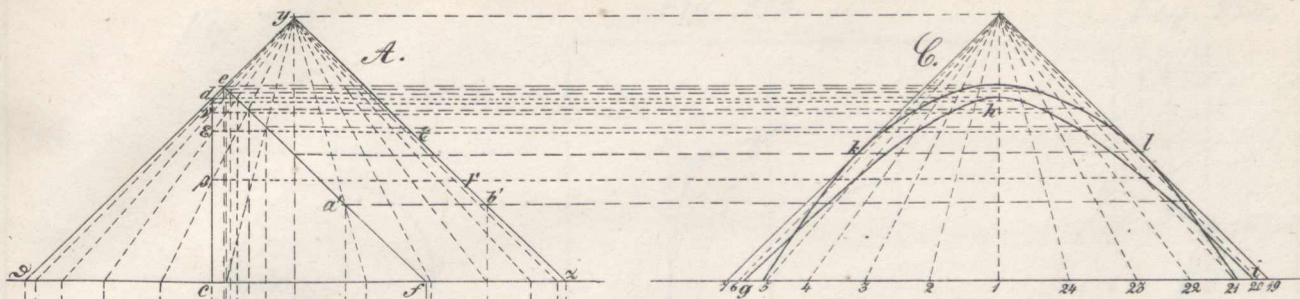

Fig. 209.

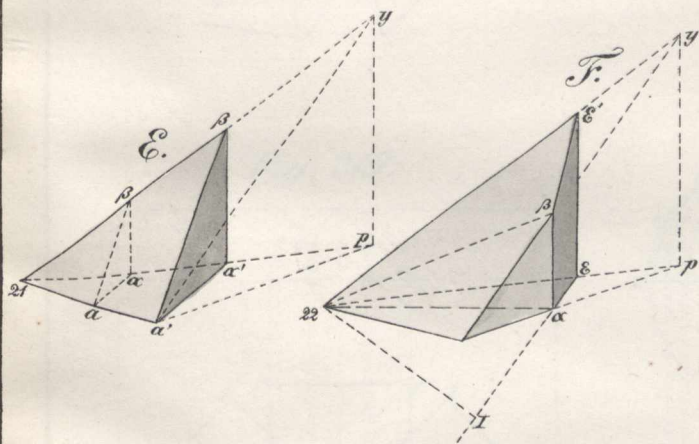

Fig. 210.

Fig. 211.

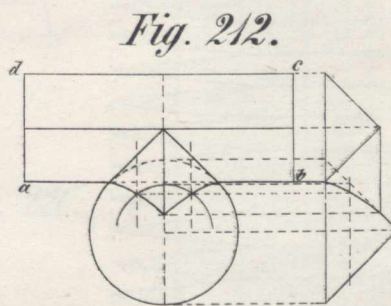
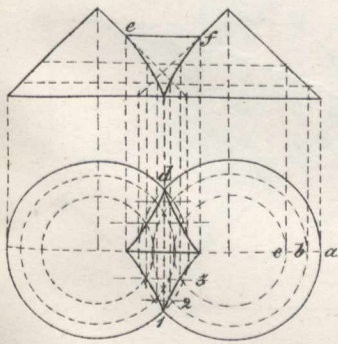

Fig. 212.

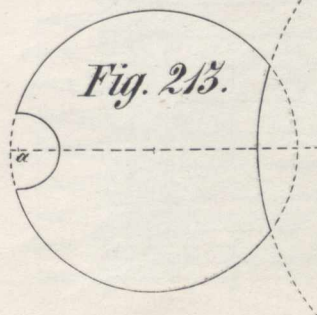
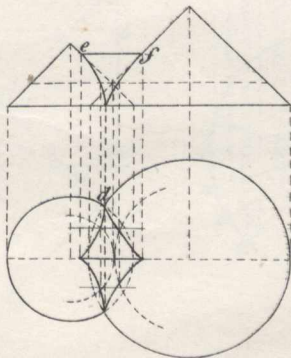

Fig. 213.



BIBLIOTHEK d. TECHNISCHEN  
HOCHSCHULE  
BRESLAU  
ABT. d. ST. u. UNIV.-BIBL.







BIBLIOTHEK d. TECHNISCHEN  
HOCHSCHULE  
BRESLAU  
ABT. d. ST. u. UNIV.-BIBL.



Fig. 221.

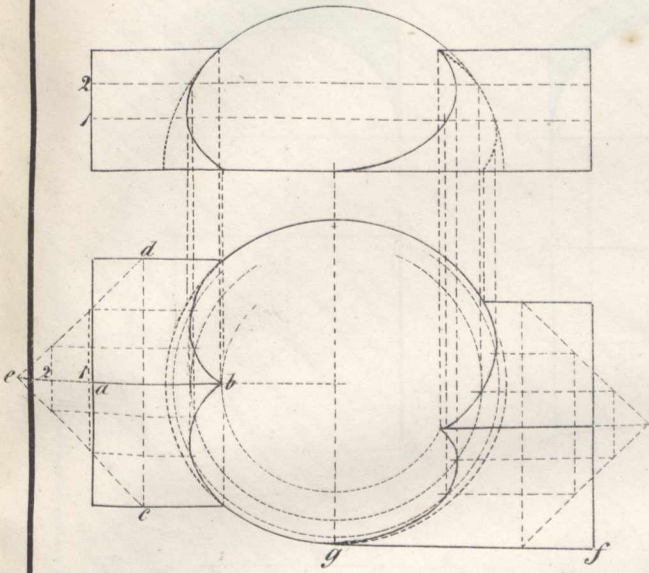
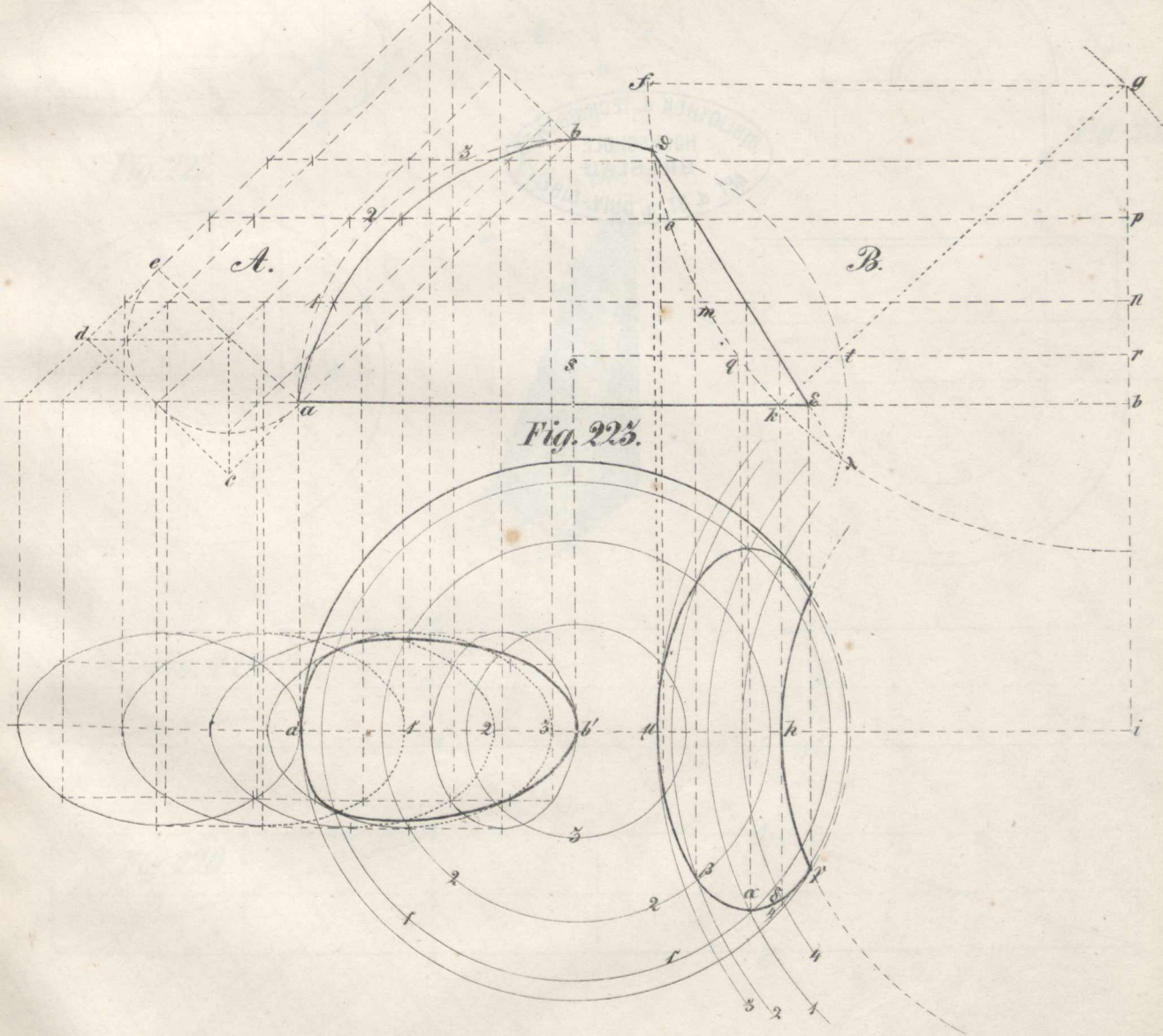
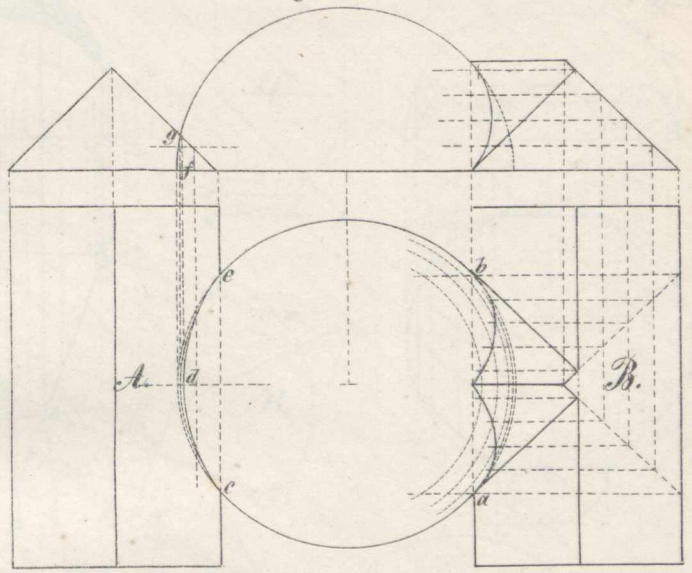

Fig. 222.





BIBLIOTHEK d. TECHNISCHEN  
HOCHSCHULE  
BRESLAU  
ABT. d. ST. u. UNIV.-BIBL.



Fig. 224.

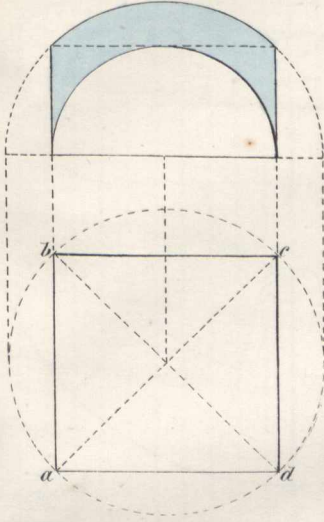

Fig. 225.

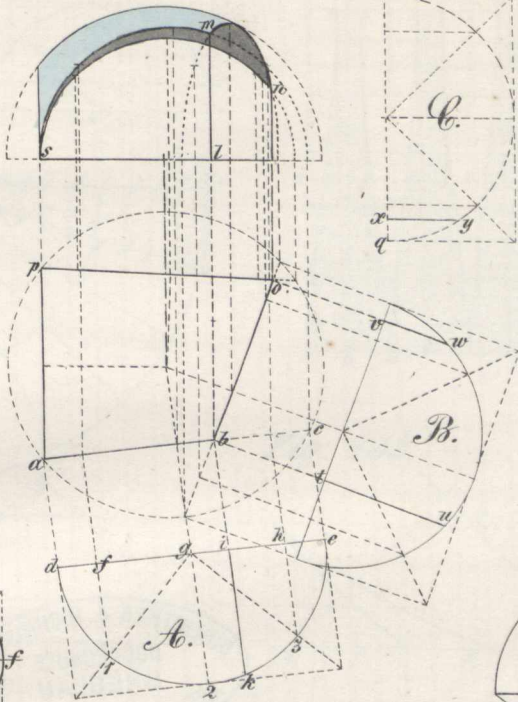

Fig. 227.

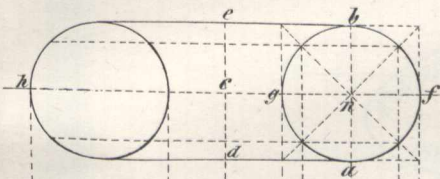
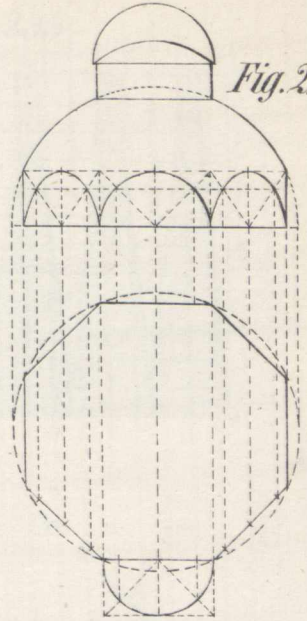

Fig. 227.

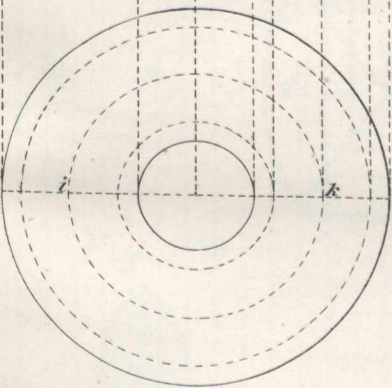

Fig. 230.

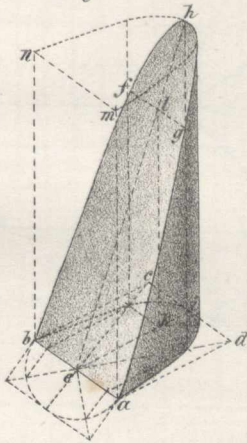

Fig. 231.

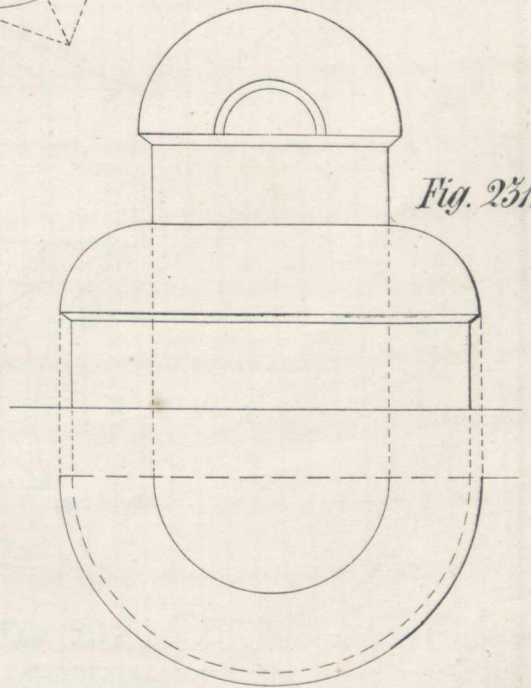

Fig. 228.

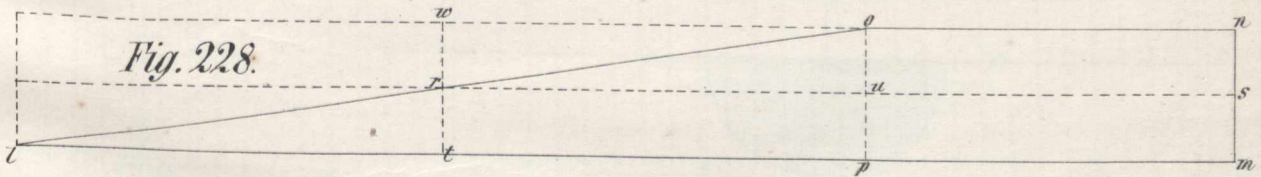
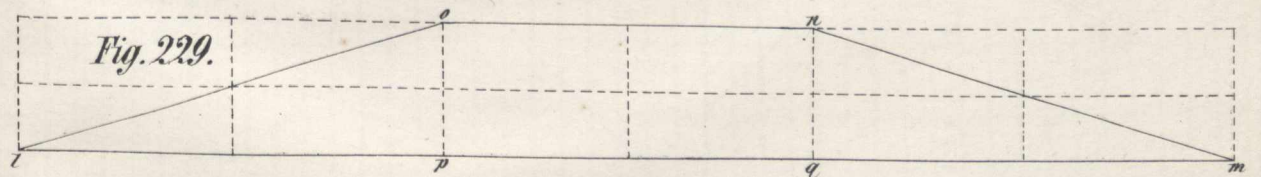

Fig. 229.





BIBLIOTHEK d. TECHNISCHEN  
HOCHSCHULE  
BRESLAU  
ABT. d. ST. u. UNIV.-BIBL.



Fig. 232.

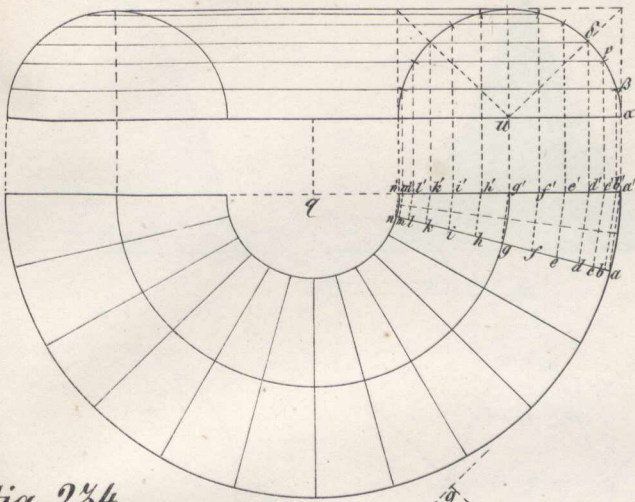

Fig. 233.

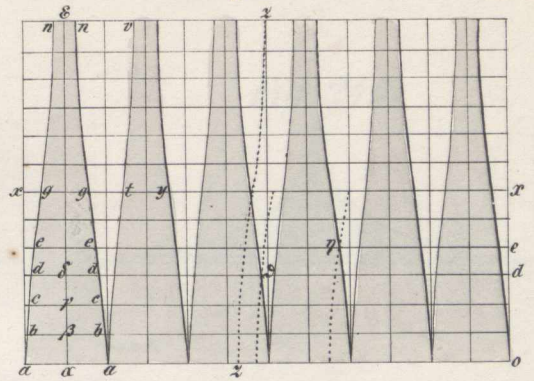

Fig. 234.

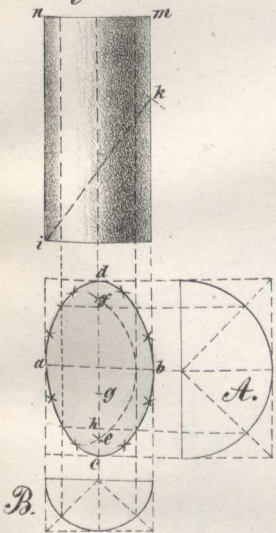

Fig. 235.

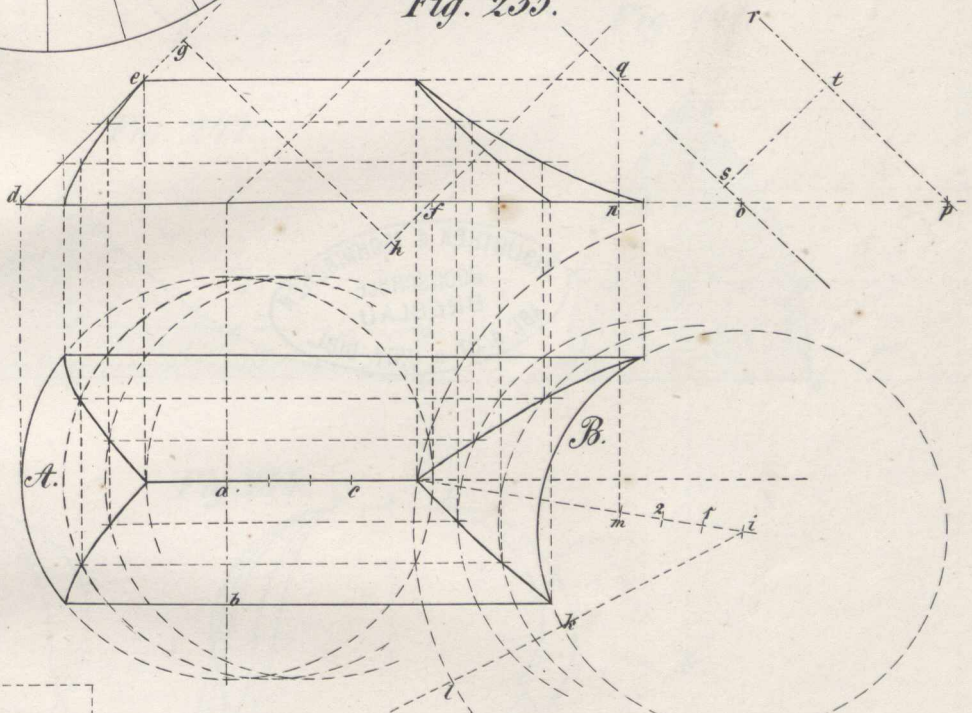

Fig. 236.

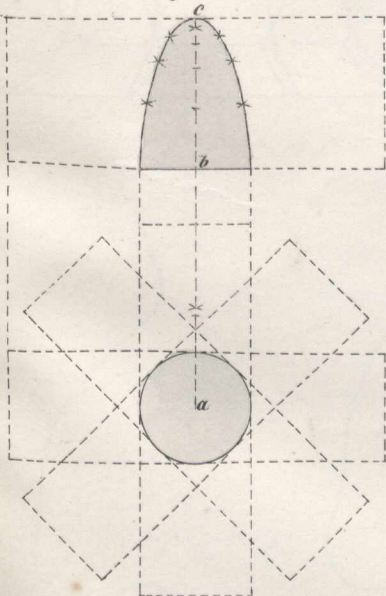
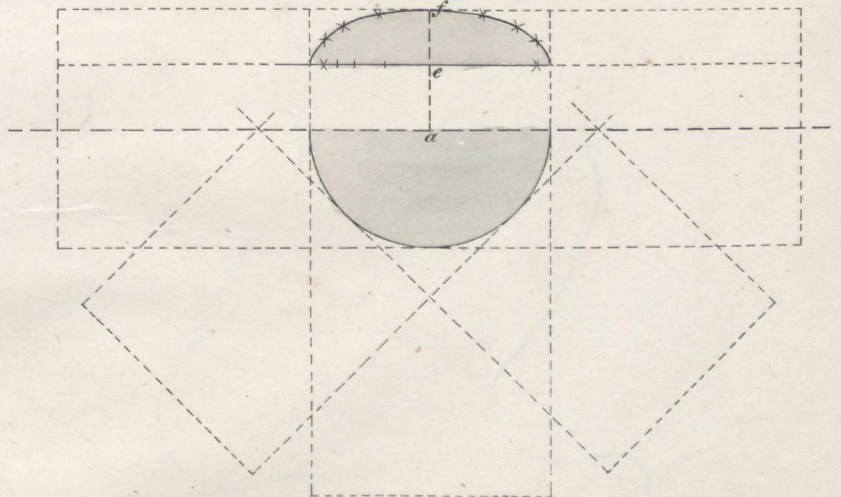

Fig. 237.





BIBLIOTHEK d. TECHNISCHEN  
HOCHSCHULE  
BRESLAU  
ABT. d. ST. u. UNIV.-BIBL.



Fig. 238.

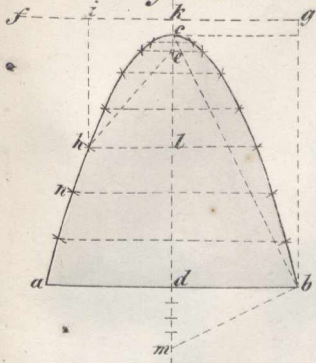

Fig. 239.

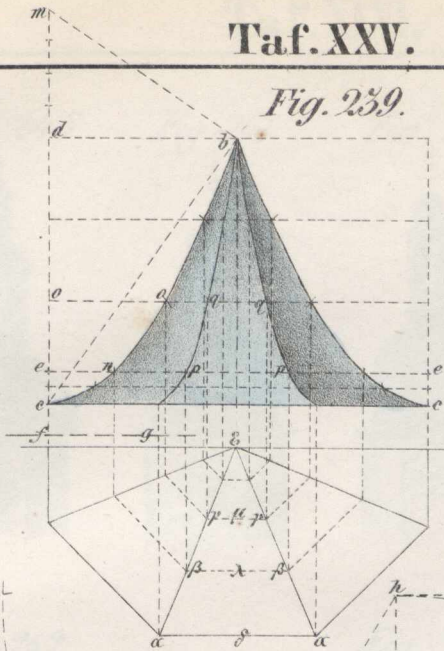

Fig. 240.

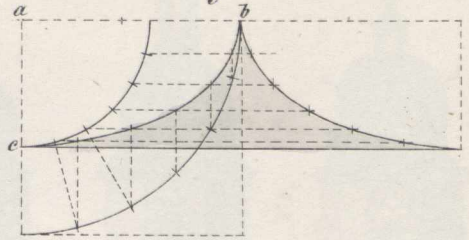

Fig. 241.

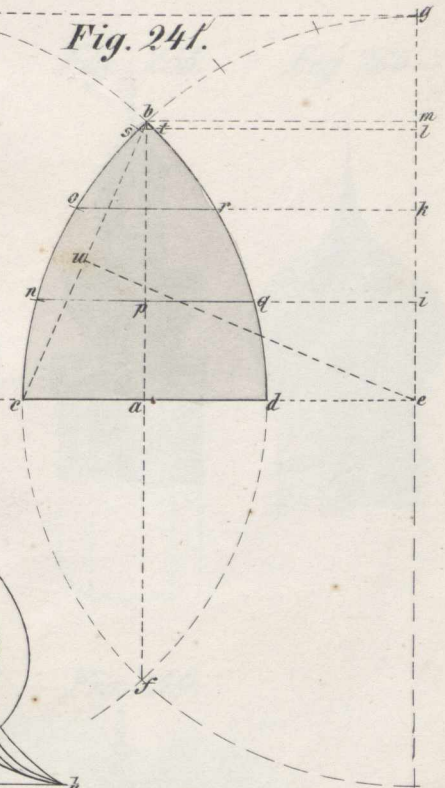

Fig. 242.

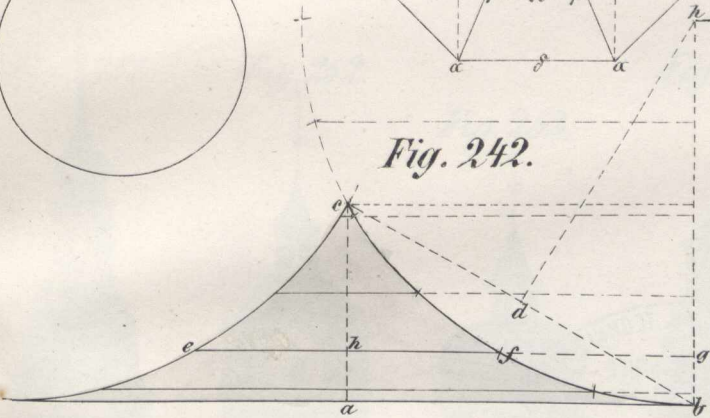

Fig. 243.

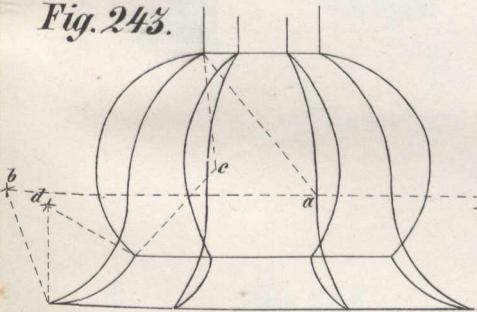
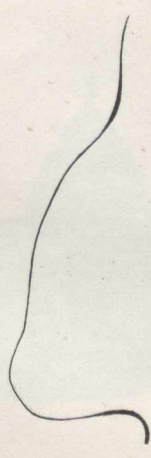
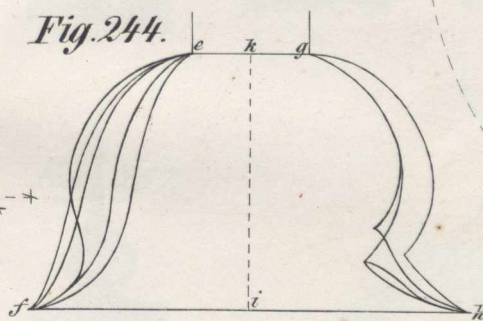

Fig. 244.





BIBLIOTHEK d. TECHNISCHEN  
HOCHSCHULE  
BRESLAU  
ABT. d. ST. u. UNIV.-BIBL.



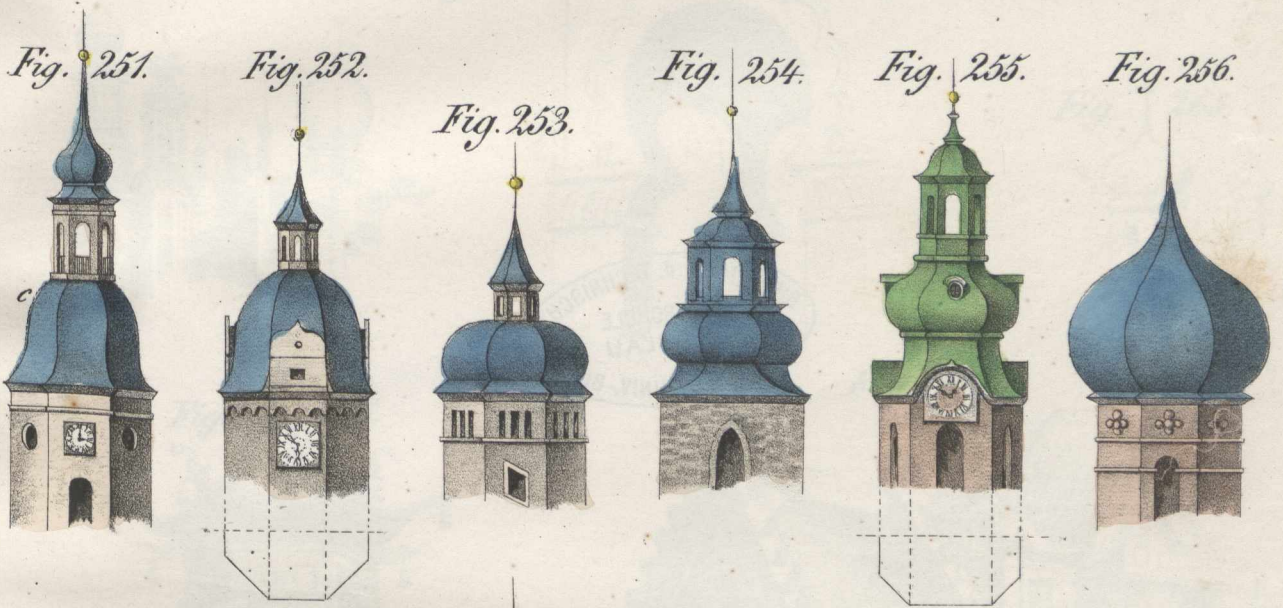
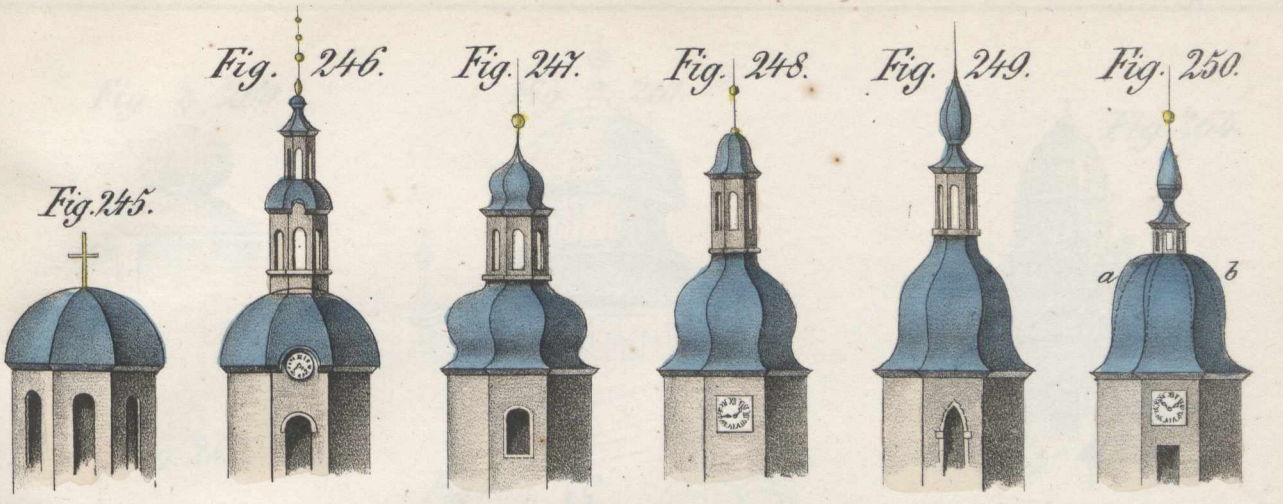



BIBLIOTHEK d. TECHNISCHEN  
HOCHSCHULE  
BRESLAU  
ABT. d. ST. u. UNIV.-BIBL.



Fig. 260.



Fig. 261.



Fig. 264.

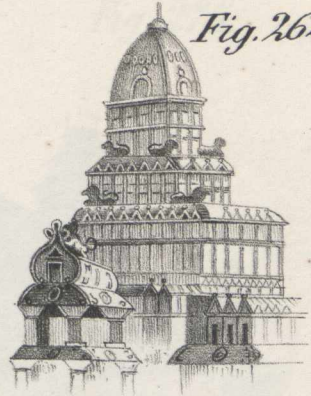

Fig. 262.



Fig. 263.

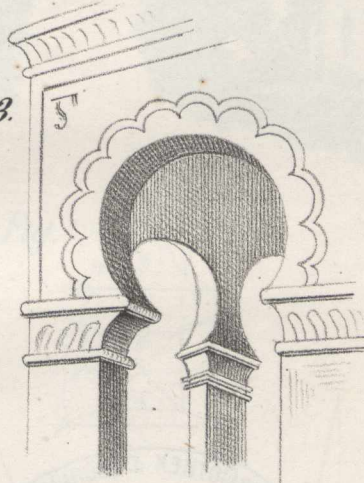

Fig. 265.

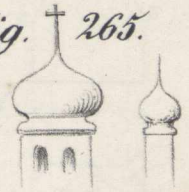

Fig. 266.

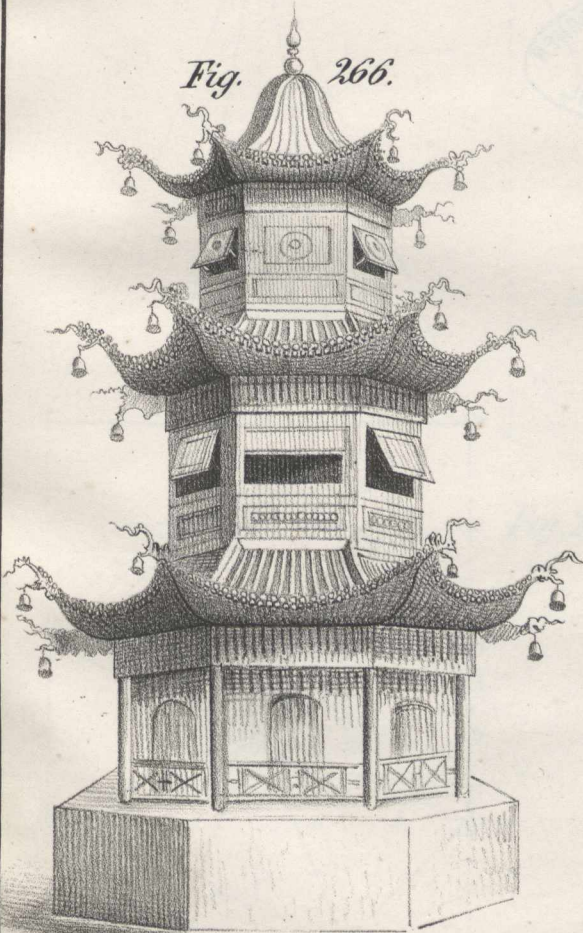

Fig. 268.

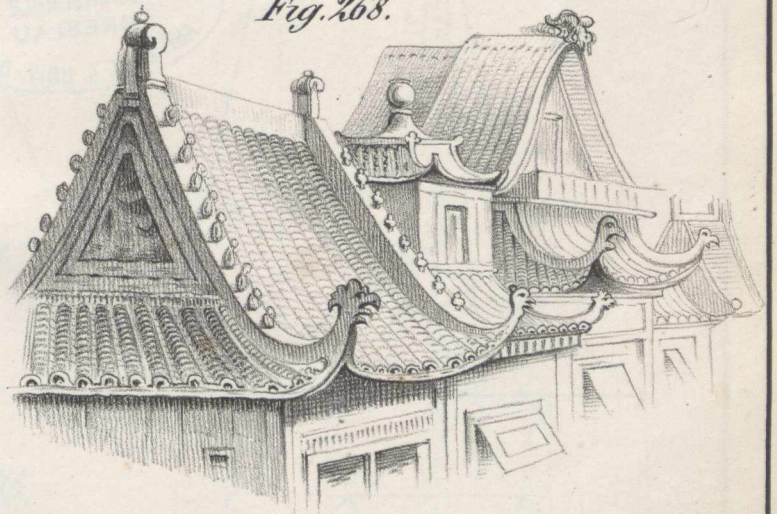

Fig. 267.

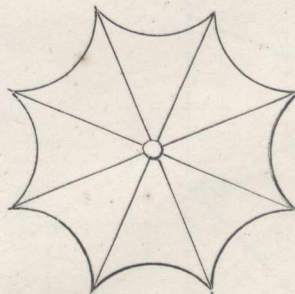
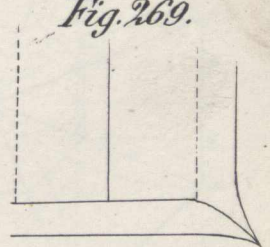

Fig. 269.





BIBLIOTHEK d. TECHNISCHEN  
HOCHSCHULE  
BRESLAU  
ABT. d. ST. u. UNIV.-BIBL.



Fig. 270.



Fig. 273.

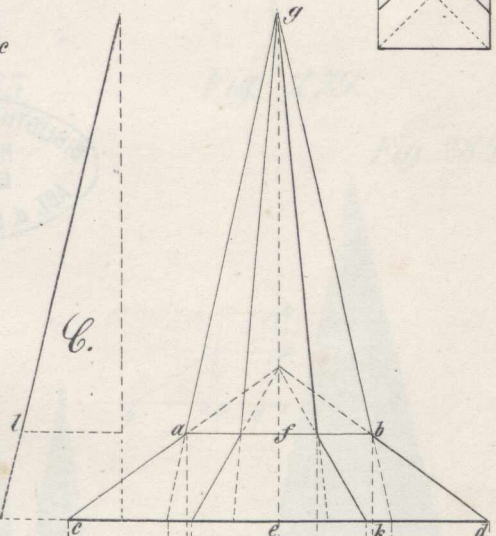
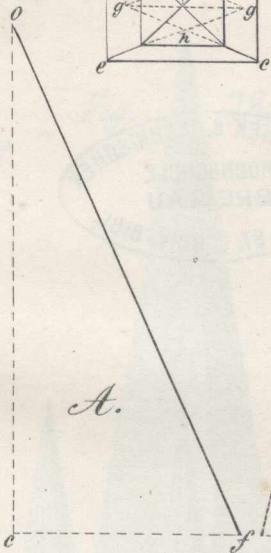
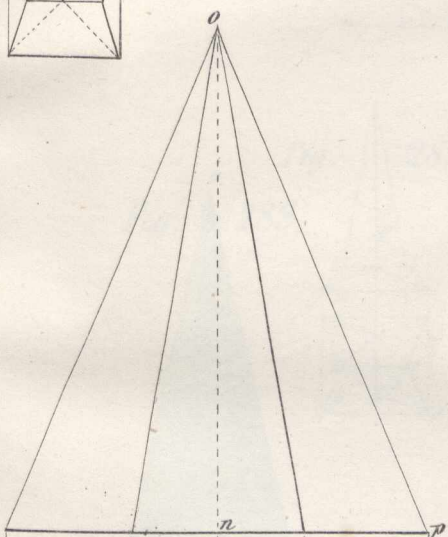
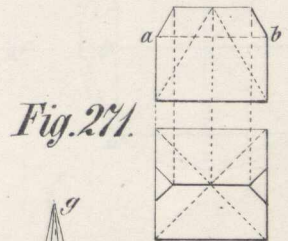
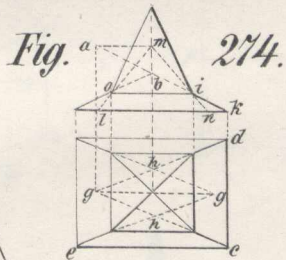
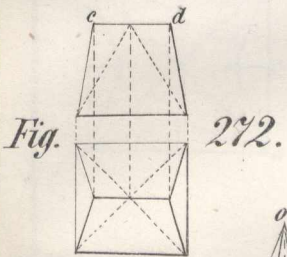
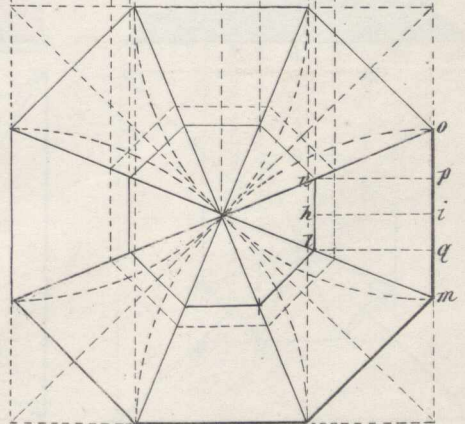
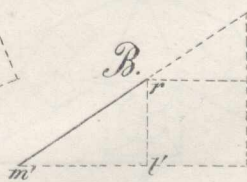
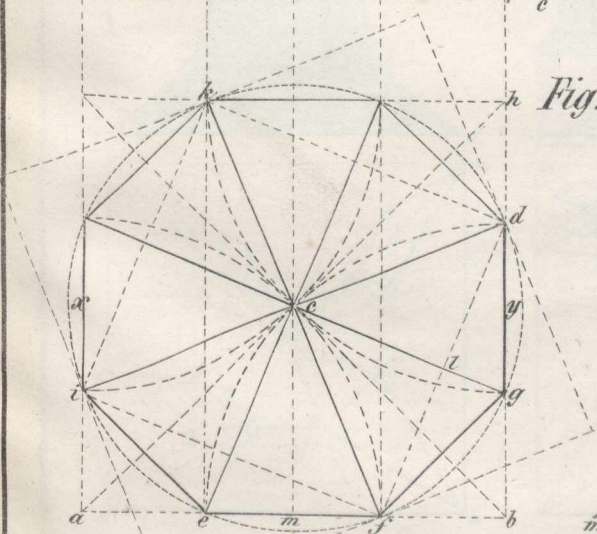

Fig. 275.

Fig. 276.





1872

1872

1872

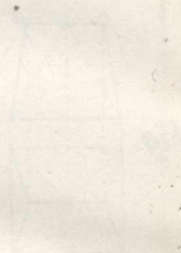
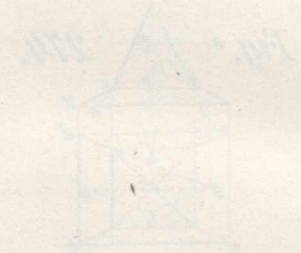

BIBLIOTHEK d. TECHNISCHEN  
HOCHSCHULE  
BRESLAU  
ABT. d. ST. u. UNIV.-BIBL.

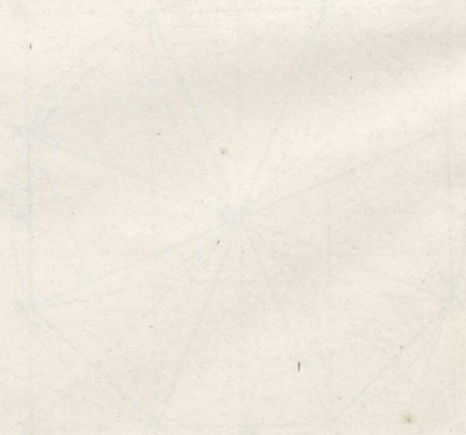
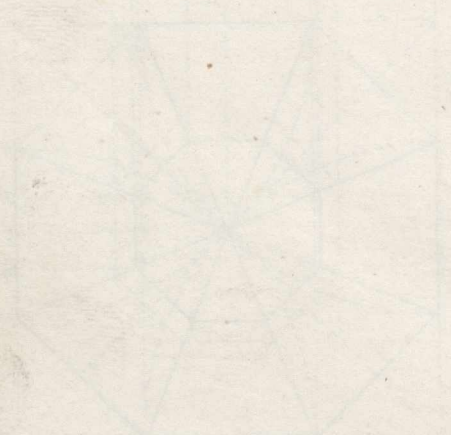



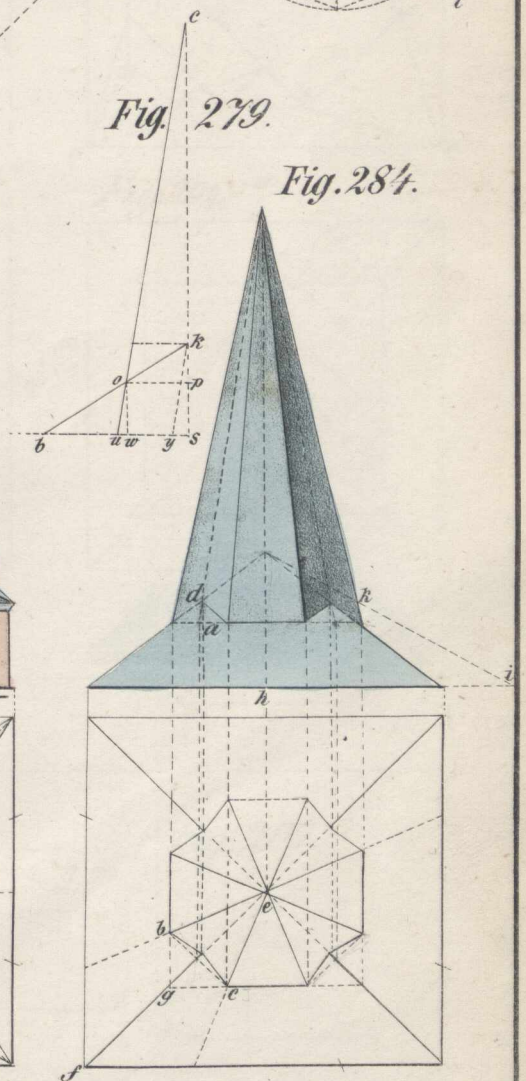
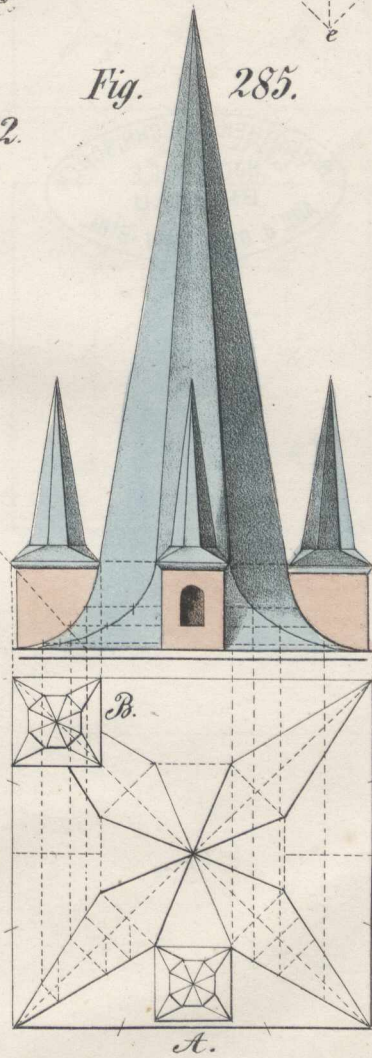
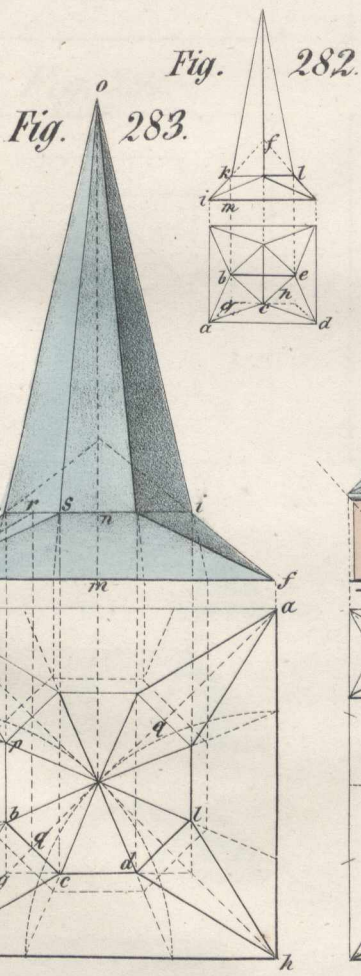
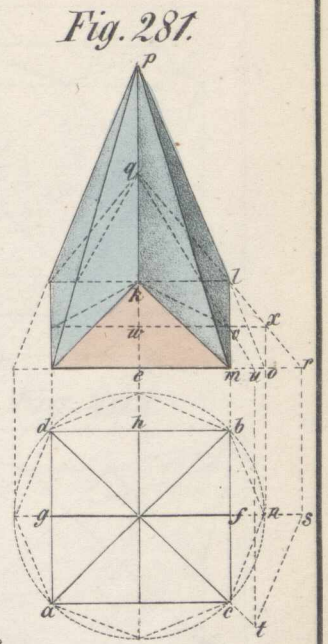
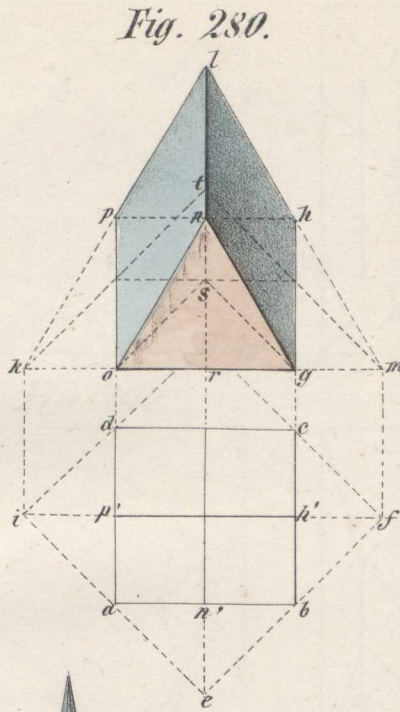
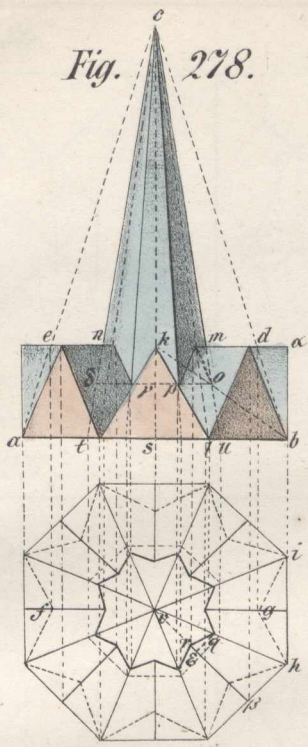
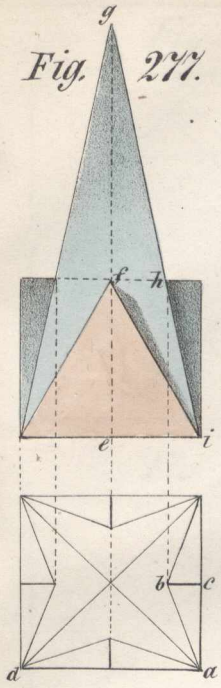



BIBLIOTHEK d. TECHNISCHEN  
HOCHSCHULE  
BRESLAU  
ABT. d. ST. u. UNIV.-BIBL.



Fig. 286.

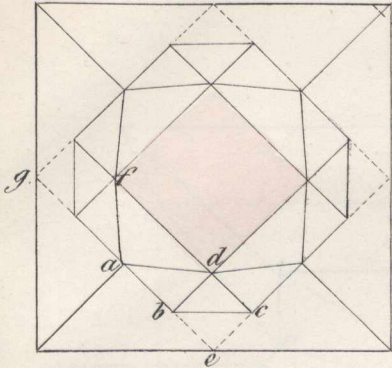

Fig. 287.

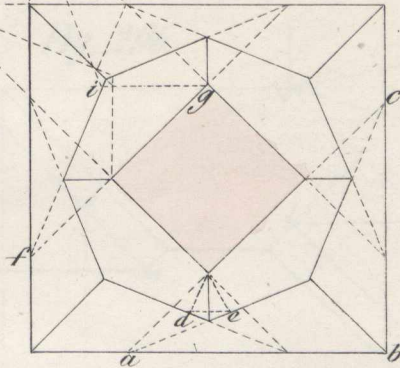

Fig. 288.

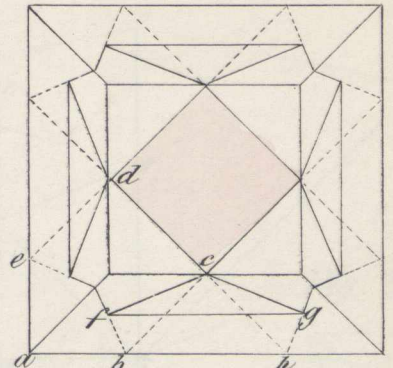

Fig. 289.

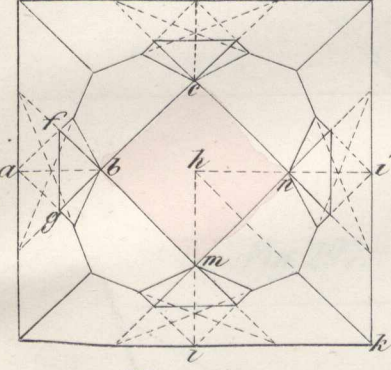

Fig. 290.

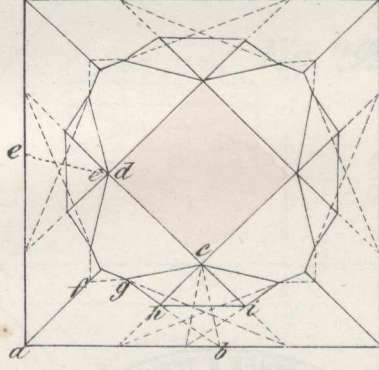

Fig. 292.

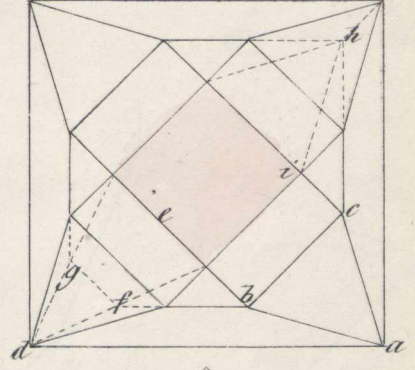

Fig. 291.

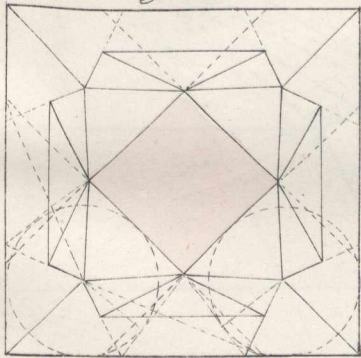

Fig. 293.

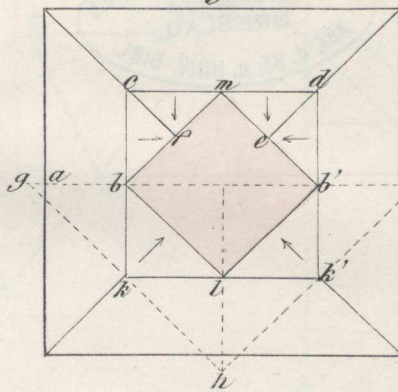

Fig. 294.

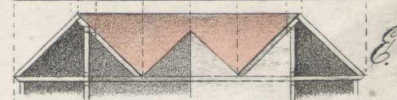
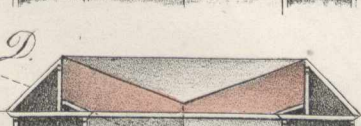
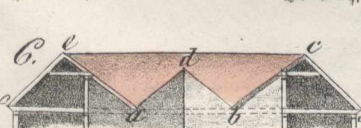
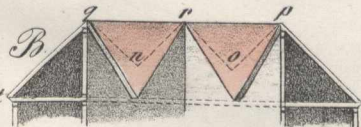
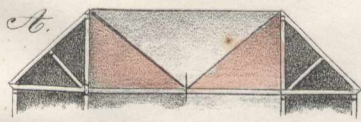
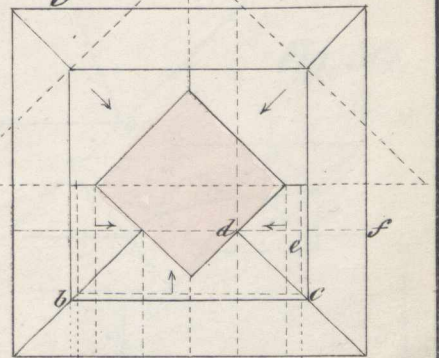
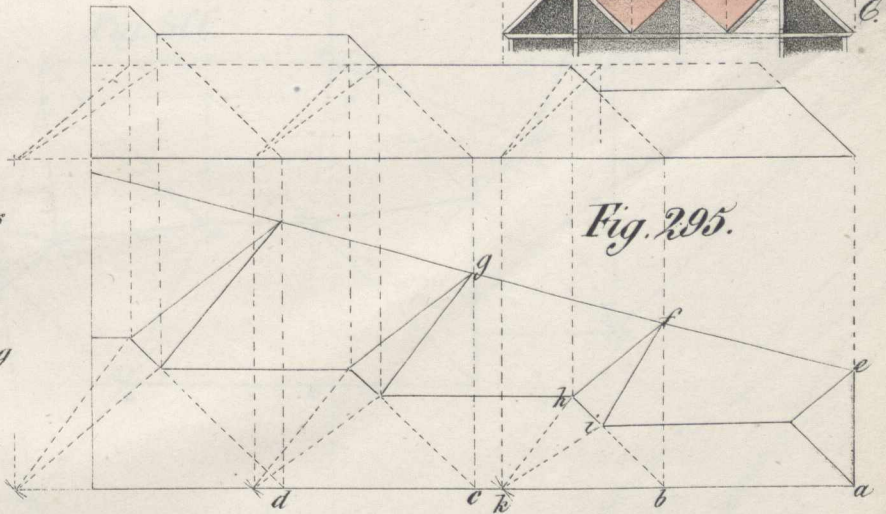

Fig. 295.





BIBLIOTHEK d. TECHNISCHEN  
HOCHSCHULE  
BRESLAU  
ABT. d. ST. u. UNIV.-BIBL.







BIBLIOTHEK d. TECHNISCHEN  
HOCHSCHULE  
BRESLAU  
ABT. d. ST. u. UNIV.-BIBL.



Fig. 302.

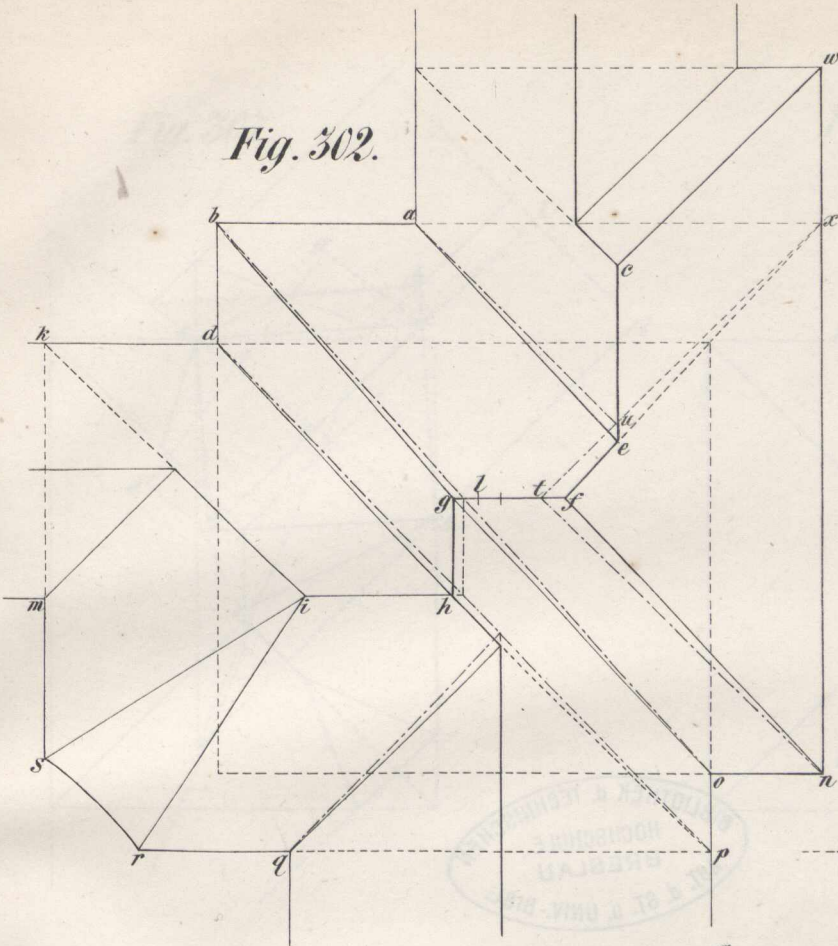

Fig. 303.

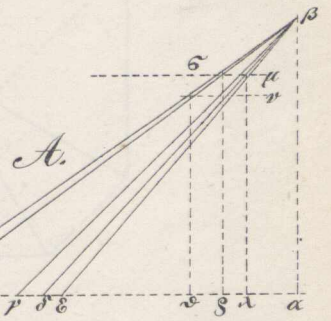
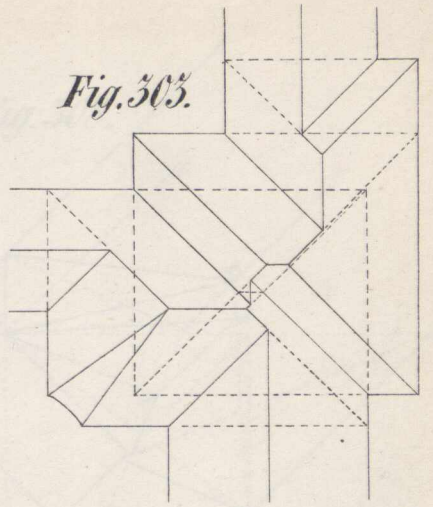

Fig. 304.

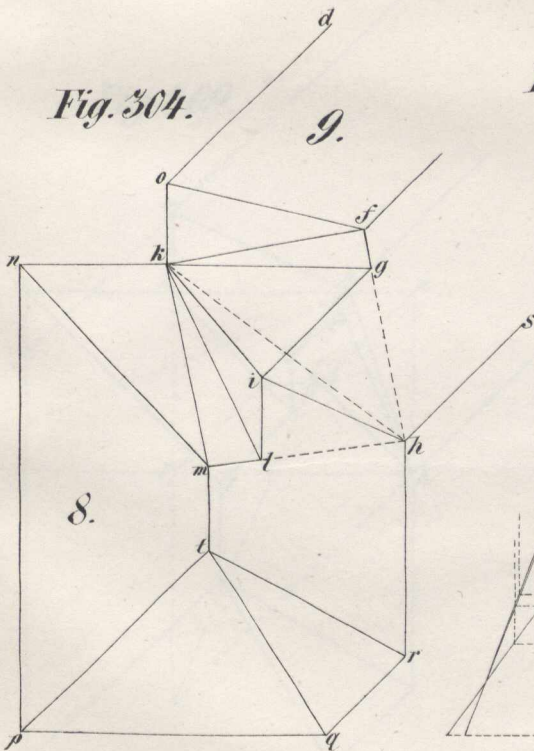

Fig. 305.

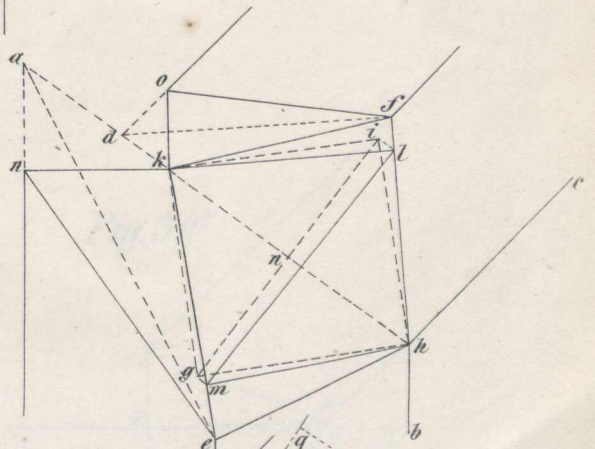
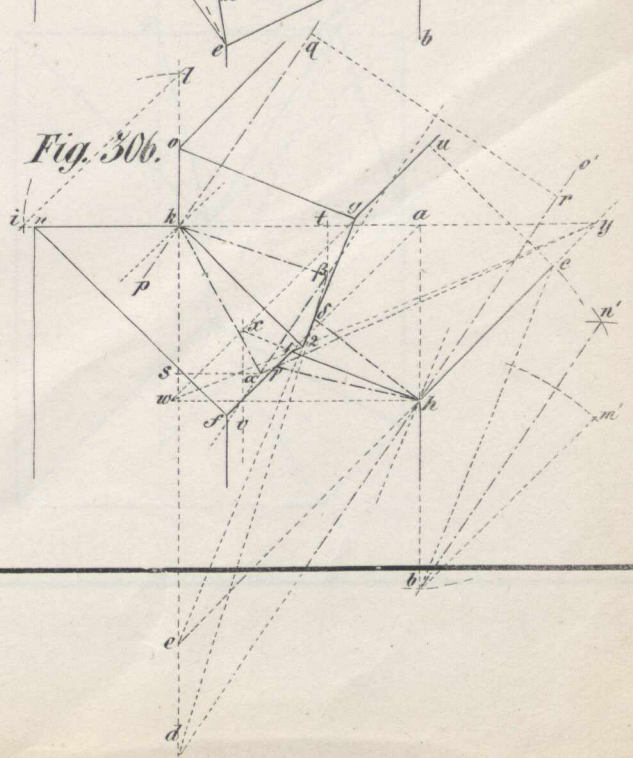

Fig. 306.





BIBLIOTHEK d. TECHNISCHEN  
HOCHSCHULE  
BRESLAU  
ABT. d. ST. u. UNIV.-BIBL.



Fig. 307.

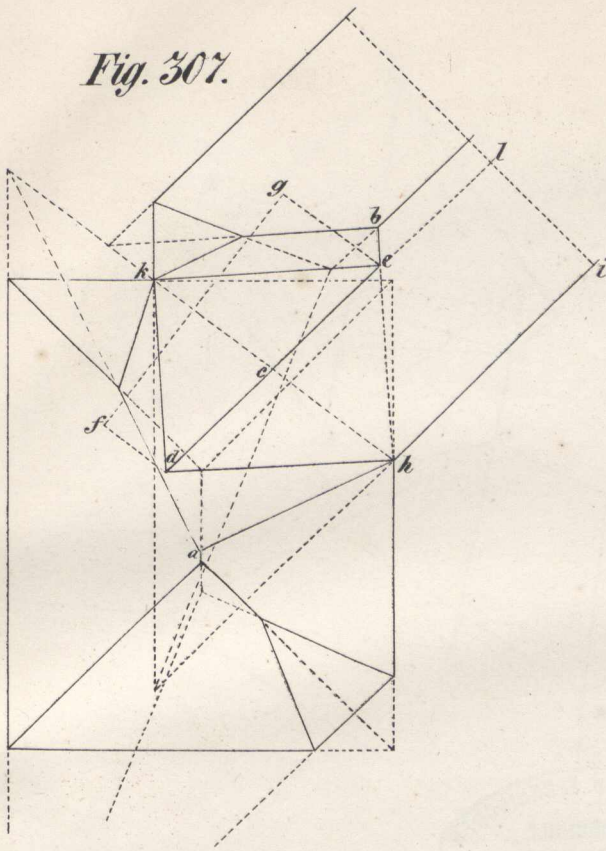

Fig. 308.

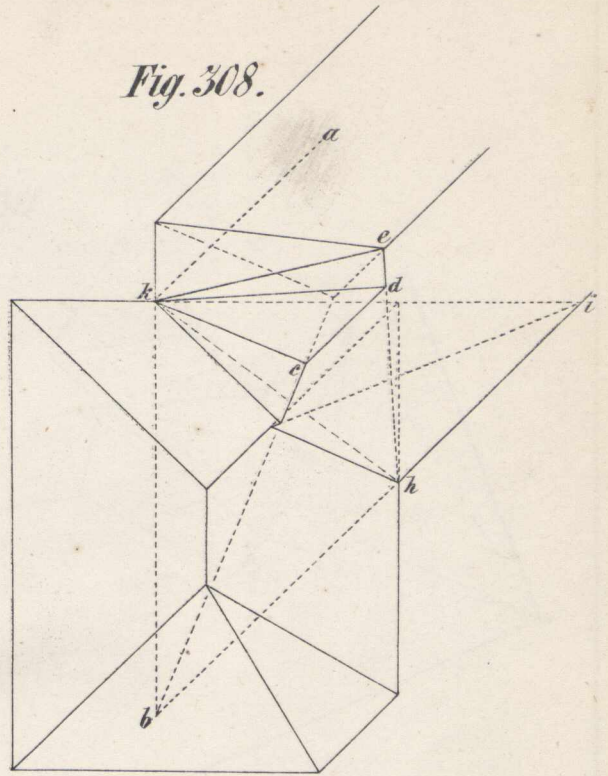

Fig. 309.

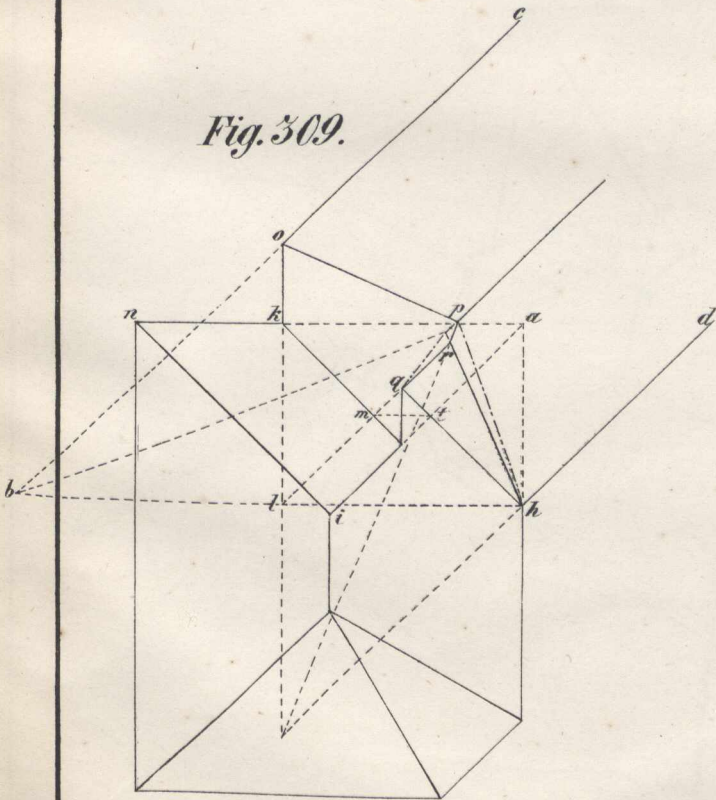
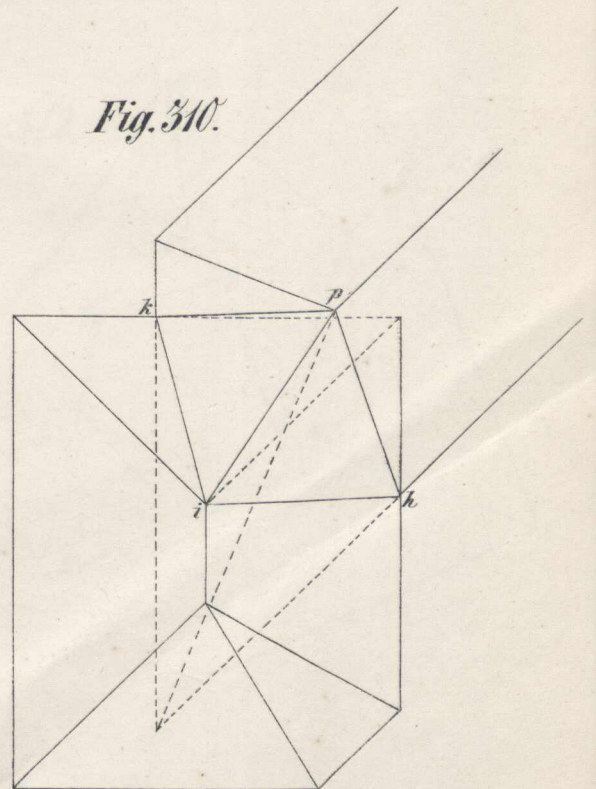

Fig. 310.





11277 168

BIBLIOTHEK d. TECHNISCHEN  
HOCHSCHULE  
BRESLAU  
ABT. d. ST. u. UNIV.-BIBL.



Fig. 311.

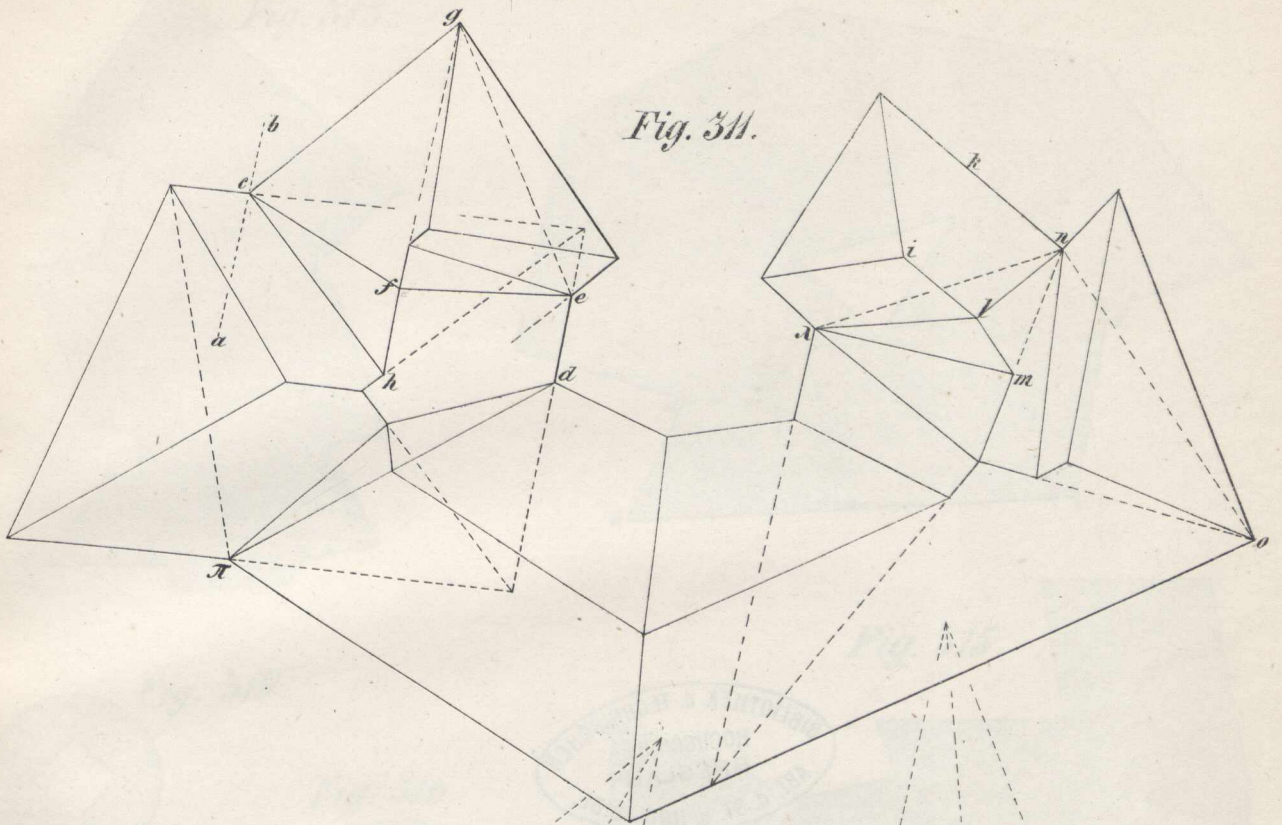
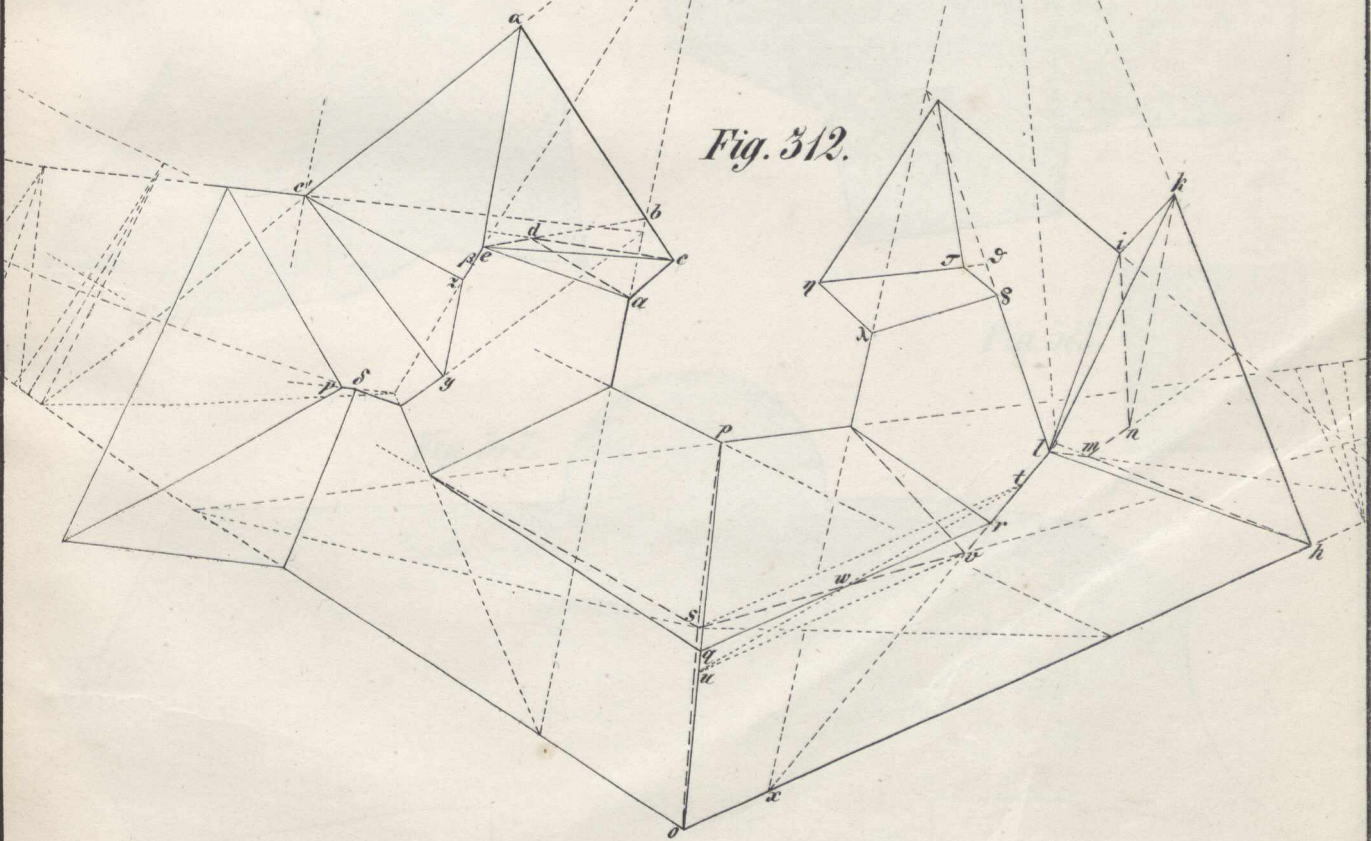

Fig. 312.



10 5 0 10 20 30 40 50 Fuß weimar. Werkmass.



BIBLIOTHEK d. TECHNISCHEN  
HOCHSCHULE  
BRESLAU  
ABT. d. ST. u. UNIV.-BIBL.



Fig. 313.

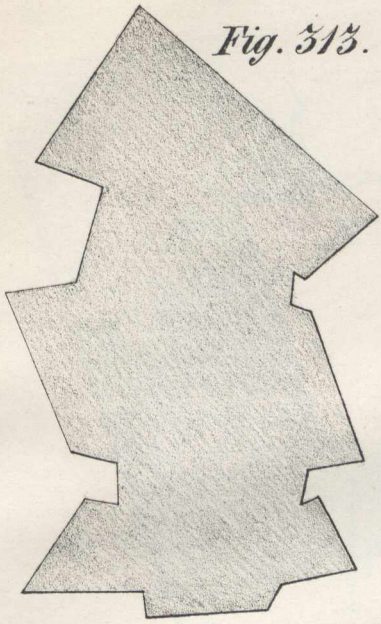

Fig. 314.

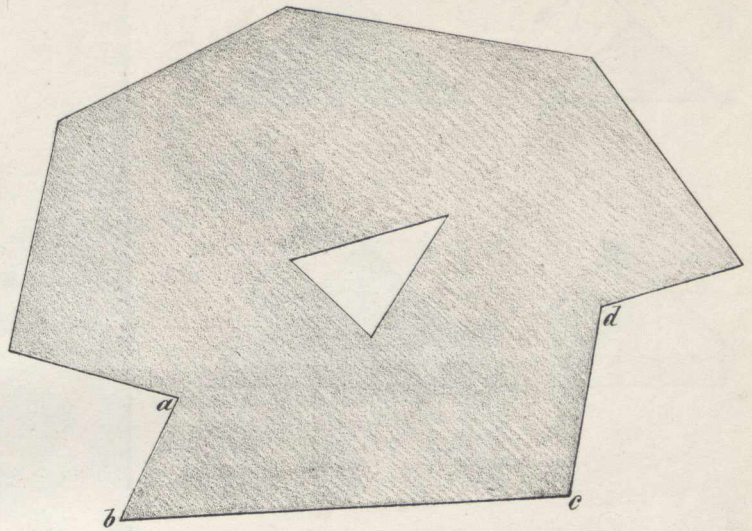

Fig. 319.

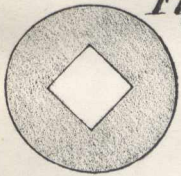

Fig. 316.

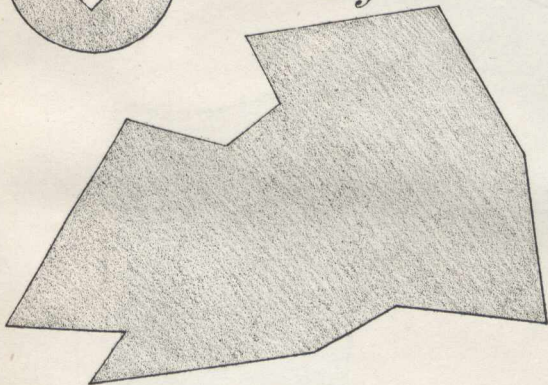

Fig. 315.

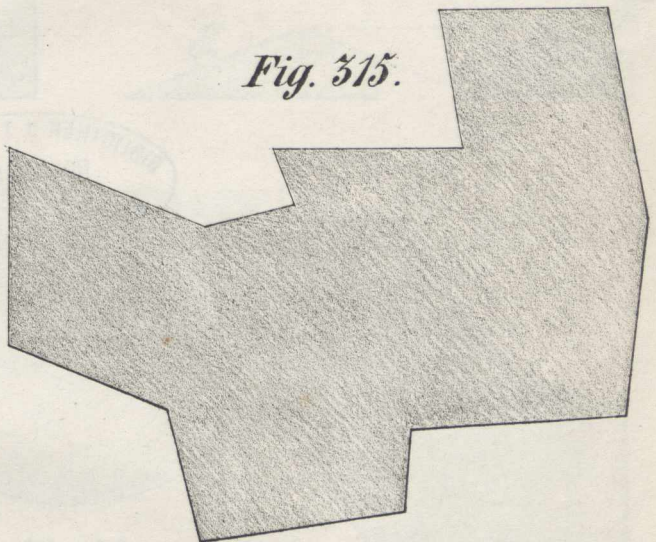

Fig. 318.

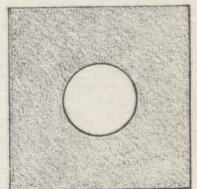
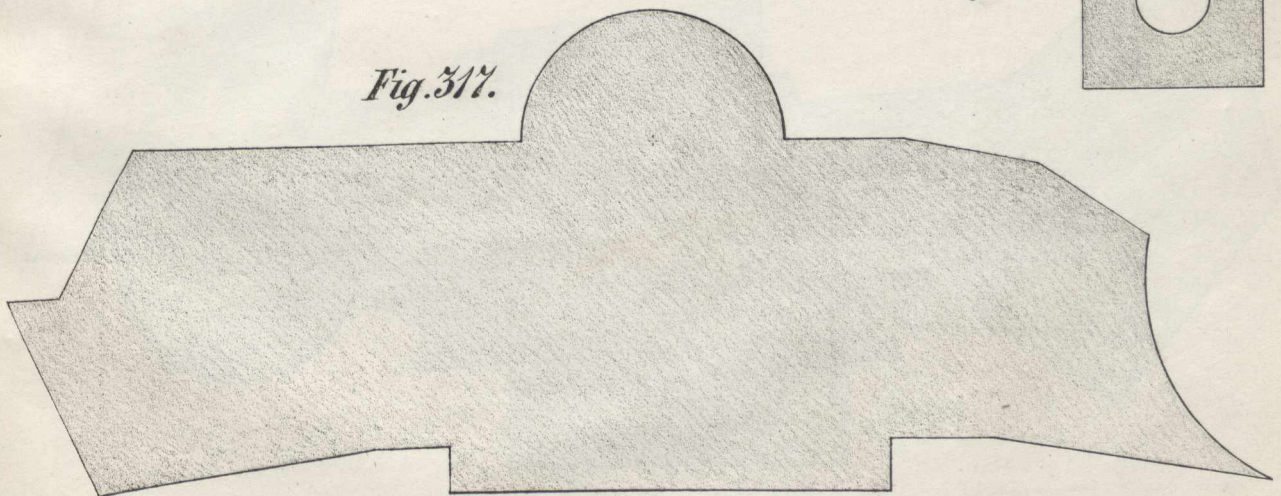

Fig. 317.





BIBLIOTHEK d. TECHNISCHEN  
HOCHSCHULE  
BRESLAU  
ABT. d. ST. u. UNIV.-BIBL.



Fig. 320.

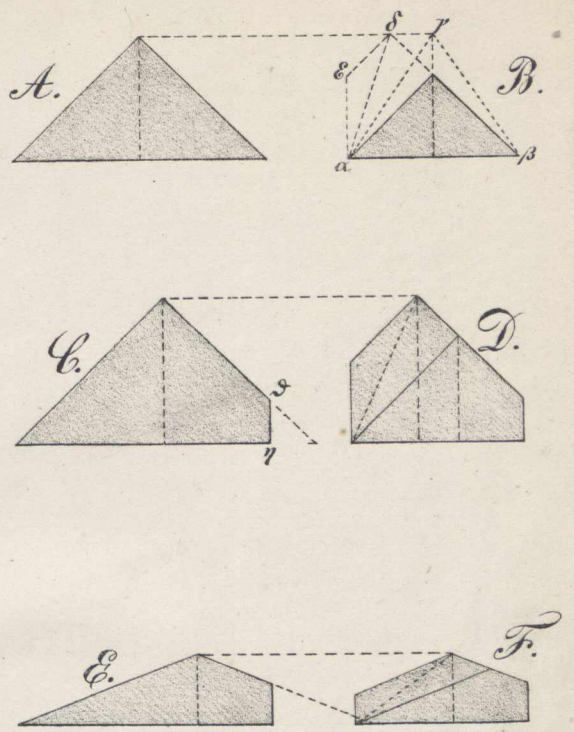
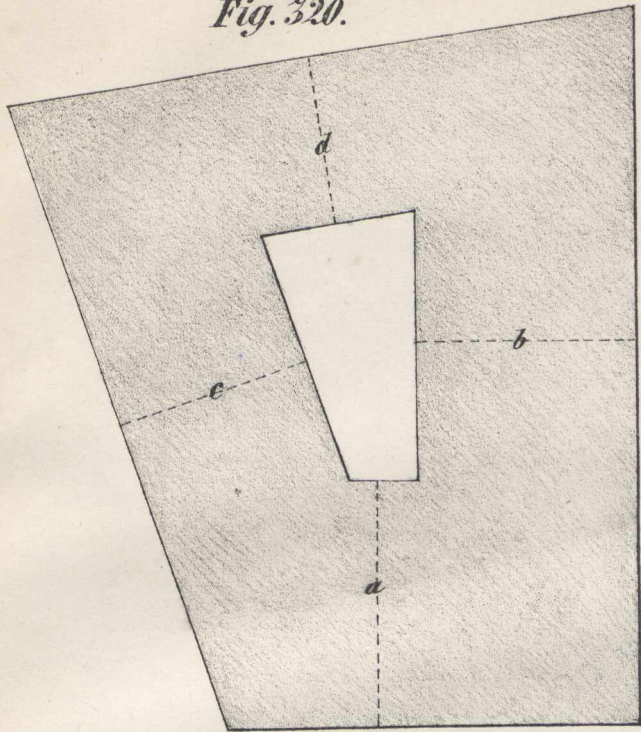
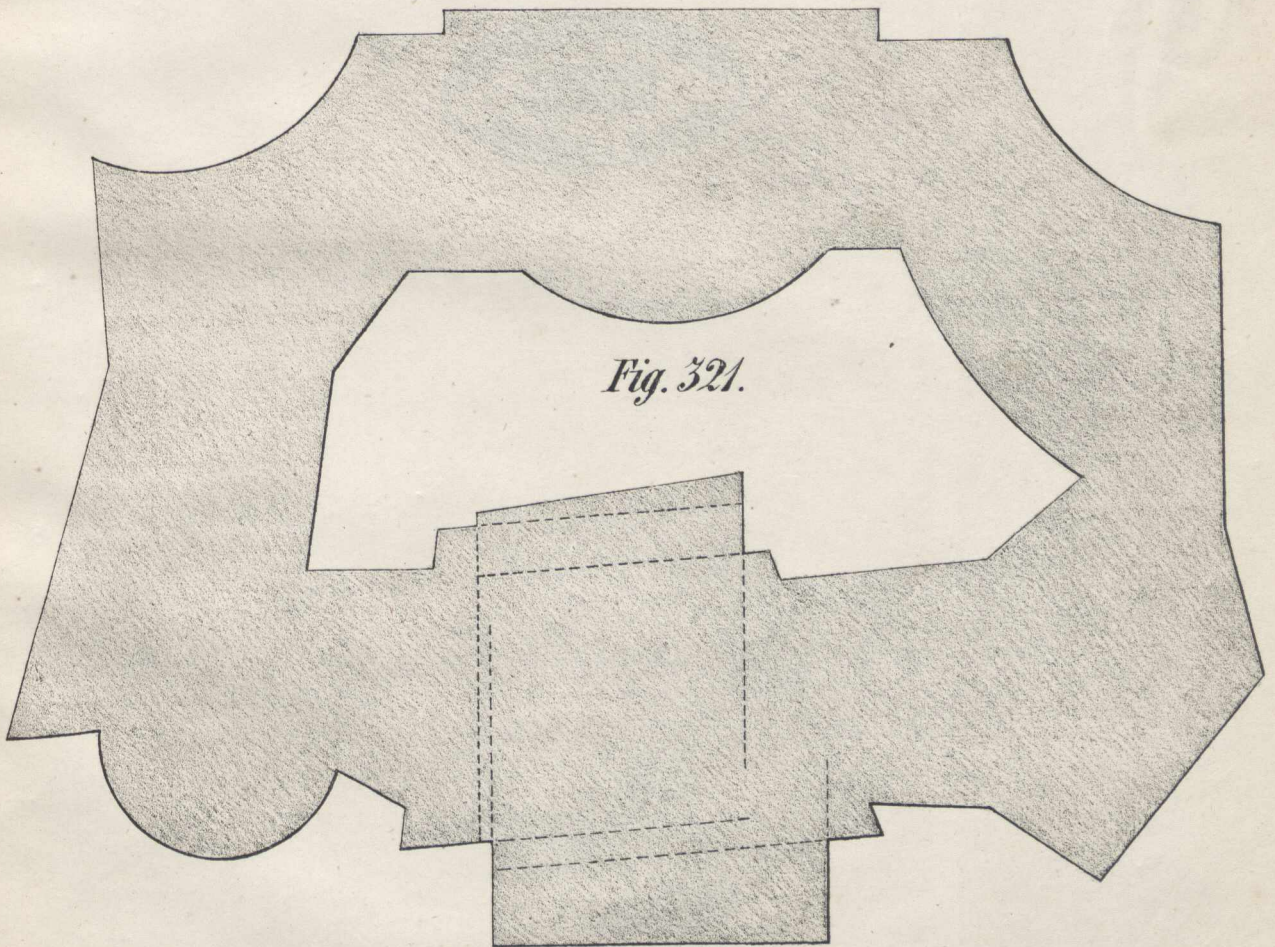

Fig. 321.





1111 1111  
1111 1111



BIBLIOTHEK d. TECHNISCHEN  
HOCHSCHULE  
BRESLAU  
ABT. d. ST. u. UNIV.-BIBL.















