

MAREK KALENIK¹

EXPERIMENTAL INVESTIGATIONS OF INTERFACE VALVE FLOW CAPACITY IN THE RoeVac TYPE VACUUM SEWAGE SYSTEM

The results of investigations of an interface valve flow capacity in a vacuum sewage system have been presented. The investigations were carried out in an experimental vacuum sewage system installation, built in a laboratory. The flow of liquid and air through the interface valve was measured for three opening times: 6, 9, 12 s. Based on the obtained results, nomograms were carried out to determine the coefficient f and the interface valve flow capacity. The nomograms may be used in design processes and in exploitation of the RoeVac type vacuum sewage system.

1. INTRODUCTION

The European standard on design of vacuum sewage system [1] precisely specifies that a vacuum sewage system is intended to transport domestic and industrial sewage on developed land excluding rain waters. The design requirements contained in the standard are minimum requirements which do not contain full guidelines, sufficient to design a properly functioning system. The norm does not specify neither a scope of detailed design nor the materials applied to construct the components of a system. The vacuum sewage systems should be designed individually, considering recommendations of suppliers.

The details concerning design guidelines for vacuum sewage systems can be found in available domestic and foreign literature [2–12]. On account of very complicated hydraulic flow conditions [13–16], the design guidelines based on a mathemati-

¹Division of Water Supply and Sewage Systems, Department of Civil Engineering, Faculty of Civil and Environmental Engineering, Warsaw University of Life Sciences, ul. Nowoursynowska 159, 02-776 Warsaw, Poland, e-mail: marek_kalenik@sggw.pl

cal description of real hydraulic work conditions of the systems still have not been defined. In the available literature, there is no data concerning flow capacity of interface valves working in unsteady conditions.

The aim of this paper was to present the analysis of research on the flow capacity of an interface valve which works in unsteady conditions of liquid and air flow. The paper concerns the interface valve used in the RoeVac type vacuum sewage system from Roediger [17].

2. DESCRIPTION OF THE MEASURING POSITION

The experimental vacuum sewage system was built in a laboratory in its natural dimensions with the materials and devices being typically used for vacuum sewage systems. Four Roediger interface knots [17], mounted at various heights, were applied: two of them located on the floor level and two – at 2.0 m above the floor on a steel rail scaffolding. As the vacuum sewage systems are recommended to build on flat areas, the difference between the altitudes of the pipeline levels in the installation is small, amounting to 3.0 m [1, 18]. The pipelines of the experimental vacuum sewage system were mounted on the appropriately prepared steel rail scaffolding. The total length of individual pipeline branches is as follows: the 63 mm pipelines – 96 m, the 90 mm pipelines – 44 m, the 110 mm pipelines – 42 m.

In Figure 1, the scheme of the experimental vacuum sewage system is presented. The observation stands from 1a to 6a–d were made of transparent PMMA pipes and the remaining piping network – of PVC pipes. The transparent segments of the vacuum pipes allow one to observe flow structures of a medium under various conditions. A transparent container (15) serves to supervise a vacuum pump as well as prevents water from splashing onto the laboratory floor while the pump is set in motion. The applied vacuum vessel (2) has the volume of 2.5 m³. The media transported in the installation are water and air. The installation can operate as closed or open system and under unsteady as well as steady conditions.

The operational sequence of the installation under unsteady flow conditions is as follows: as the throttling valve (14) has been opened and the vacuum pump (1) has been switched on, an underpressure appears in the vacuum vessel (2) and in the system of vacuum pipelines (3)–(5). When the underpressure, read from the electronic meter of absolute pressure (13), has value 0.02 MPa, the water pump (9) is switched on and pumps liquid from the vacuum vessel (2) through the pressure pipeline (10) to appropriate collection sumps (11a–d). Next, the control valve (8f) closes and the control valve (8e) opens, along with appropriate control valves (8a–d). The interface valves open automatically in a random way, depending on a liquid level in the individual collection sumps.

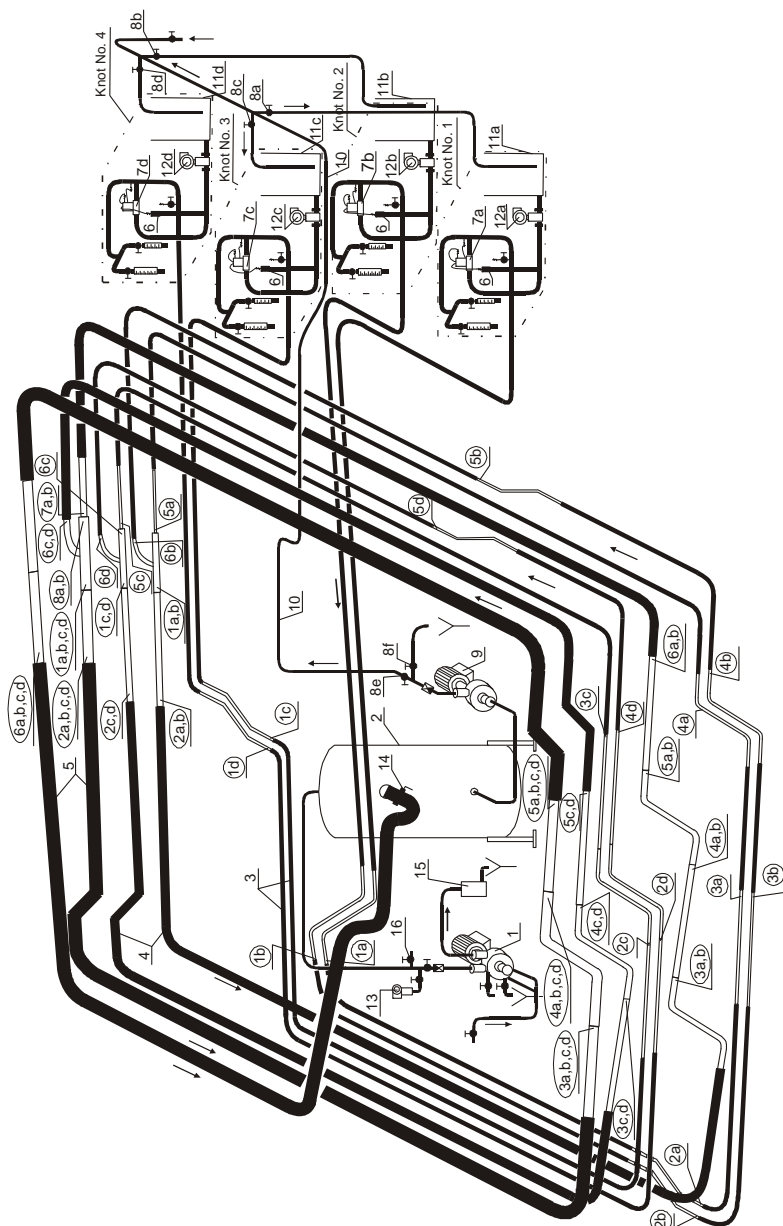

Fig. 1. Scheme of the installation of the experimental vacuum sewage system: 1 – vacuum pump, 2 – vacuum vessel, 3 – 63 mm vacuum pipeline, 4 – 90 mm vacuum pipeline, 5 – 110 mm vacuum pipeline, 6 – sensor pipe, 7a–d – interface valves, 8a–f – control valves, 9 – water sump, 10 – pressure pipeline, 11a–d – collection sumps, 12a–d – electronic liquid flowmeters, 13 – electronic absolute pressure meter, 14 – throttling valve, 15 – transparent container, 16 – vacuum vessel – undersurface regulation valve, 1a–6d – flow structure observation posts

After filling the appropriate collection sump with water and arising the appropriate pressure in the sensor pipe (6), this pressure is transmitted to the air-operated controller through the impulse hose. Then the interface valves (7a–d) open and water from the collection sump is sucked out to the vacuum pipelines network. As the liquid has been completely sucked out from the collection sump, the interface valve remains opened for a few seconds during which the air is sucked into the experimental vacuum sewage system.

3. RESEARCH METHOD

In the measurements the installation of experimental vacuum sewage system (Fig. 1) was used. The investigation of the interface valve flow capacity was made in unsteady flow conditions. The internal diameter of the investigated interface valve amounted to $\varnothing = 65$ mm. In the RoeVac type vacuum sewage system, sewage is sucked in as first and air as next – directly after sewage: after the sewage has been sucked in, the interface valve stays opened during few seconds (from 3 to 8) and at that time, the air is sucked. The electronic air flow meters which are available on market are not adapted to fast stabilization if liquid flows through them at first. On account of this, the vacuum knot (Fig. 2) has been precisely sealed and equipped with an additional 75 mm pipeline, on which an electronic air flow meter was mounted.

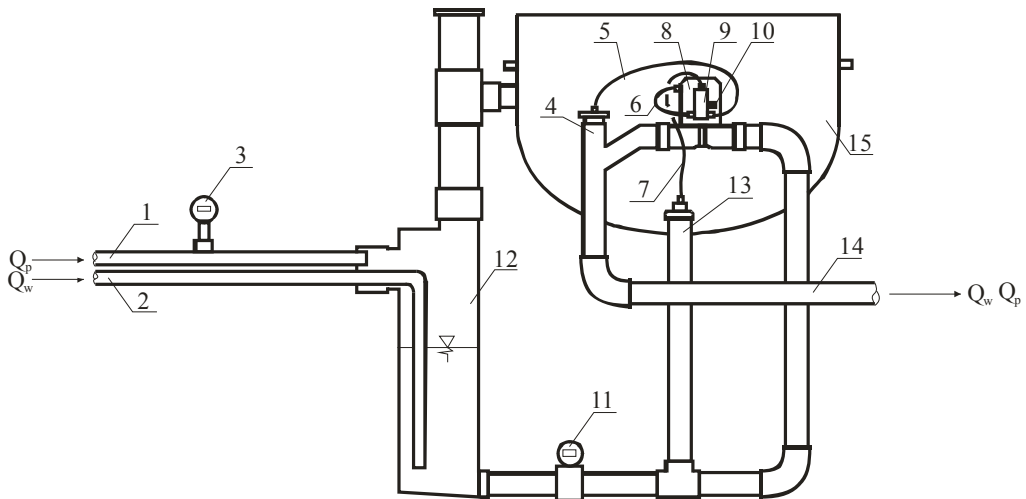

Fig. 2. Measurement of interface valve capacity: 1 – air supply pipeline, 2 – liquid supply pipeline, 3 – electronic air flow meter, 4 – pipe closed by a rubber cork, 5–7 impulse hoses, 8 – interface valve, 9 – air operated controller, 10 – impulse terminal, 11 – electronic liquid flow meter, 12 – hermetic collection sump, 13 – sensor pipe, 14 – vacuum pipeline, 15 – interface valve chamber

During the work of the experimental vacuum sewage system, as the interface valve in the knot 1 (Fig. 2) has been opened, the air is sucked to the installation through the pipeline (1). The interface valve flow capacity was determined for the case when only the knot 1 was working in the system and the flow of sucked liquid and air were maximal. Measurements were made for three opening times of the interface valve (7a, Fig. 1): 6, 9, 12 s, for various absolute pressures p_{bz} in the vacuum vessel (2). The absolute pressure p_{bz} was changed from 0.020 to 0.045 MPa with the interval 0.005 MPa. For every opening time of the interface valve, three measuring series were made. Before the beginning of each series, the current barometric pressure p_b was read out from the electronic absolute pressure meter (13, at that moment the experimental installation of the vacuum sewage system did not work). As the current barometric pressure p_b during a given measuring series and the absolute pressure p_{bz} in the vacuum vessel were known, the underpressure p_{vzp} in the vacuum vessel could be calculated. During the measurement, the constant value of the absolute pressure in the vacuum vessel was being kept for 30 min using the valve (16) and simultaneously the readings of the electronic absolute pressure meter (13) were watched. During this period of work of the system, the measuring devices in the vacuum knot (Fig. 2) were observed; moreover, when the interface valve in the knot was opened, the maximal readings of the electronic liquid flow meter (Q_w , 11) and air flow meter (Q_p , 3) were read off.

4. DISCUSSION OF RESULTS

In Figure 3, the results of research of interface valve flow capacity in unsteady liquid and air flow conditions are presented. The analysis of results of the measurements allows us to state that the individual measuring points lie closely to each other, creating distinct trend lines for individual opening times of the interface valve. The observed trend can be described in the best way by a polynomial of the second degree. The trend lines for individual opening times of the interface valve lie almost parallel to each other. If the valve opening time increases, the distance between the lines gradually decreases. The coefficient of determination from the R^2 test for individual trend lines amounts to 0.98; this means that liquid and air flow depend in 98% on the underpressure p_{vzp} in the vacuum vessel and the opening time t of the interface valve, and only in 2% on other factors. On account of this, there were determined empirical formulas (presented in Fig. 3) to calculate liquid and air flow (Q_w and Q_p , respectively) through the RoeVac type interface valve in dependence on underpressure p_{vz} in the vacuum vessel and opening time t of the interface valve.

The analysis of results allows us to state that the interface valve flow capacity depends on the underpressure p_{vzp} in the vacuum vessel and the valve opening time t . The longer time the valve stays opened and the higher is the underpressure in the vacuum vessel, the higher the valve flow capacity is.

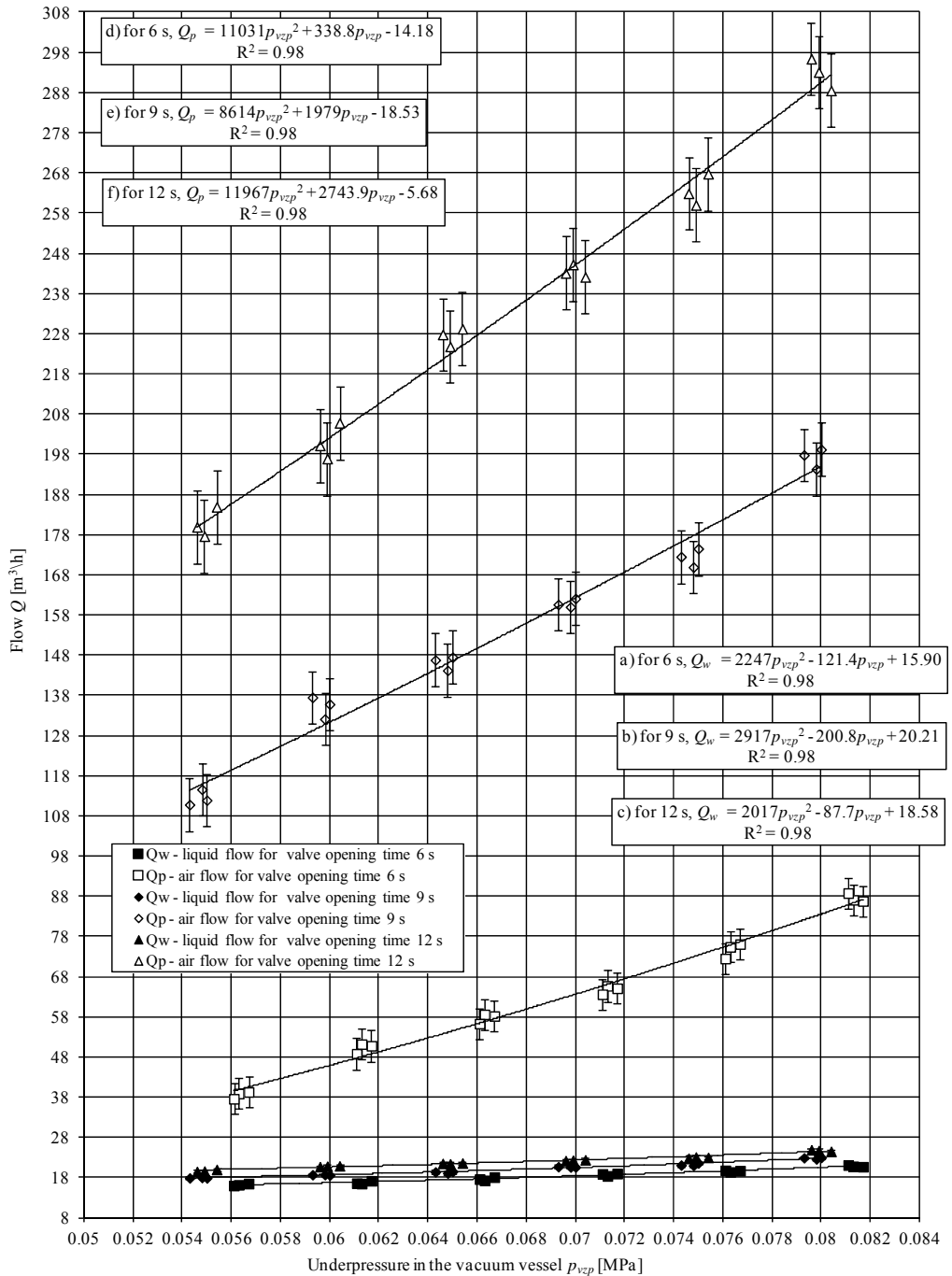

Fig. 3. Results of the investigations of interface valve capacity

The opening time t of the interface valve and increase of the underpressure p_{vzp} in the vacuum vessel have much lower influence on the liquid flow capacity Q_w than on the air flow capacity Q_p .

To design vacuum sewage systems, the coefficient f is used, defined as [16, 18]:

$$f = \frac{Q_p}{Q_w} \quad (1)$$

where: Q_p is the air flow [$\text{m}^3 \cdot \text{h}^{-1}$], and Q_w – liquid flow [$\text{m}^3 \cdot \text{h}^{-1}$].

The coefficient f is an air to liquid ratio which must be assured during sewage flow in vacuum sewage system pipelines so as the system could work correctly. At the stage of design of a vacuum sewage system, the coefficient f is recommended to be assumed from the range 2–12 [17, 19]. Moreover, the vacuum pumps in a vacuum sewage system should turn on if the underpressure in the vacuum vessel is not lower than 0.055 MPa and turn off if it is not higher than 0.070 MPa [17, 19].

On account of this, using the results of measurements (Fig. 3) for three opening times of the RoeVac type interface valve: 6, 9, 12 s, the coefficients f were calculated for various values of underpressure in the vacuum vessel.

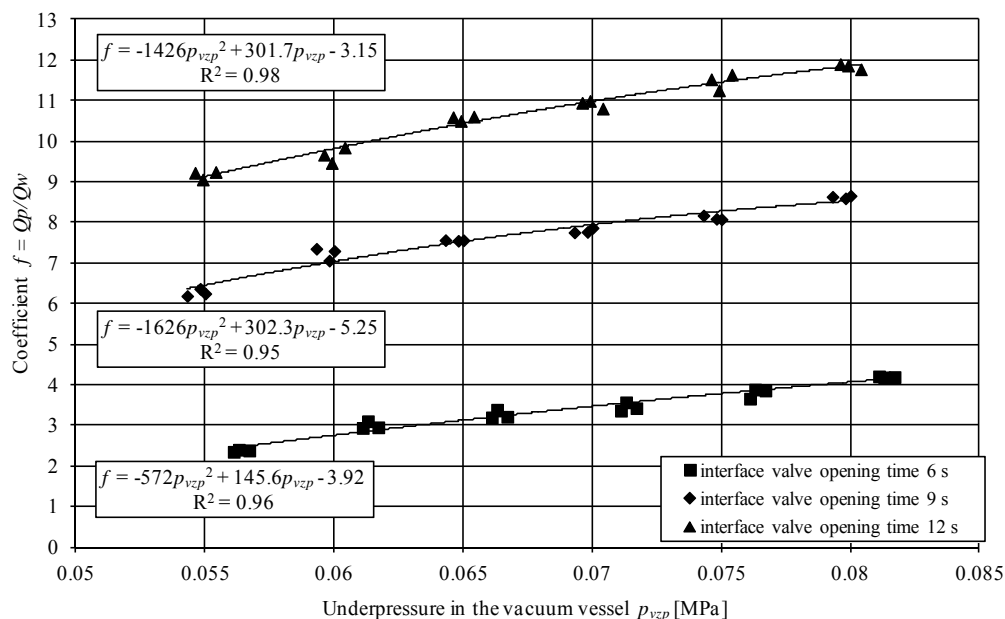

Fig. 4. Air-liquid flow ratio Q_p/Q_w (coefficient f)

The analysis of results of calculations (Fig. 4) shows that individual values of the coefficient f lie closely to each other, creating distinct lines of trend for individual

opening times of the interface valve. The observed trend can be also described in the best way by a polynomial of the second degree. The trend lines for individual opening times of the interface valve lie parallel to each other. As earlier, there can be also observed that if the valve opening time increases, the distance between the lines gradually decreases.

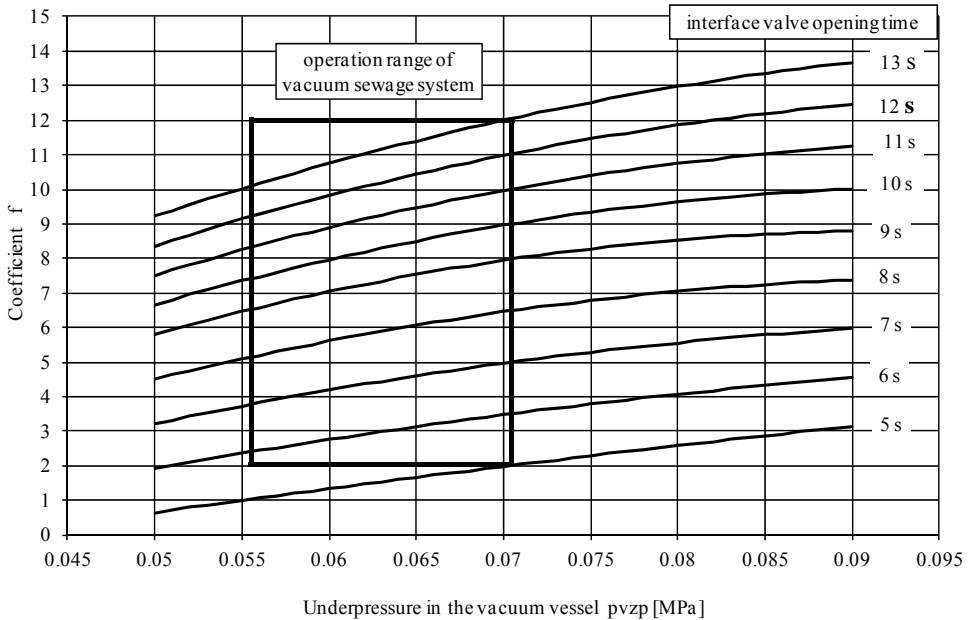

Fig. 5. Coefficient f in function of the interface valve opening time [s]

The coefficient of determination from the R^2 test for individual trend lines is higher than 0.95; this means that liquid and air flow depend in more than 95% on the underpressure p_{vzp} in the vacuum vessel and on the opening time t of the interface valve, and less than in 5% on other factors. On account of this, empirical formulas were determined (cf. Fig. 4) to calculate the coefficient f . Then, using the determined equations and the principle of interpolation of contour lines, a nomogram was constructed (Fig. 5) to calculate the coefficient f in dependence on underpressure existing in a vacuum vessel. A rectangle marked on the nomogram denotes an operation range of the vacuum sewage system.

A nomogram was also made to determine an interface valve flow capacity (Fig. 7). Based on the results of measurements (Fig. 3), the dependences of the air and liquid flow (Q_p and Q_w , respectively) on the valve opening time have been plotted (Fig. 6). As is seen, individual measuring points lie closely to each other, creating distinct lines of trend for individual opening times of the interface valve. The observed trend is described in the best way by a linear function.

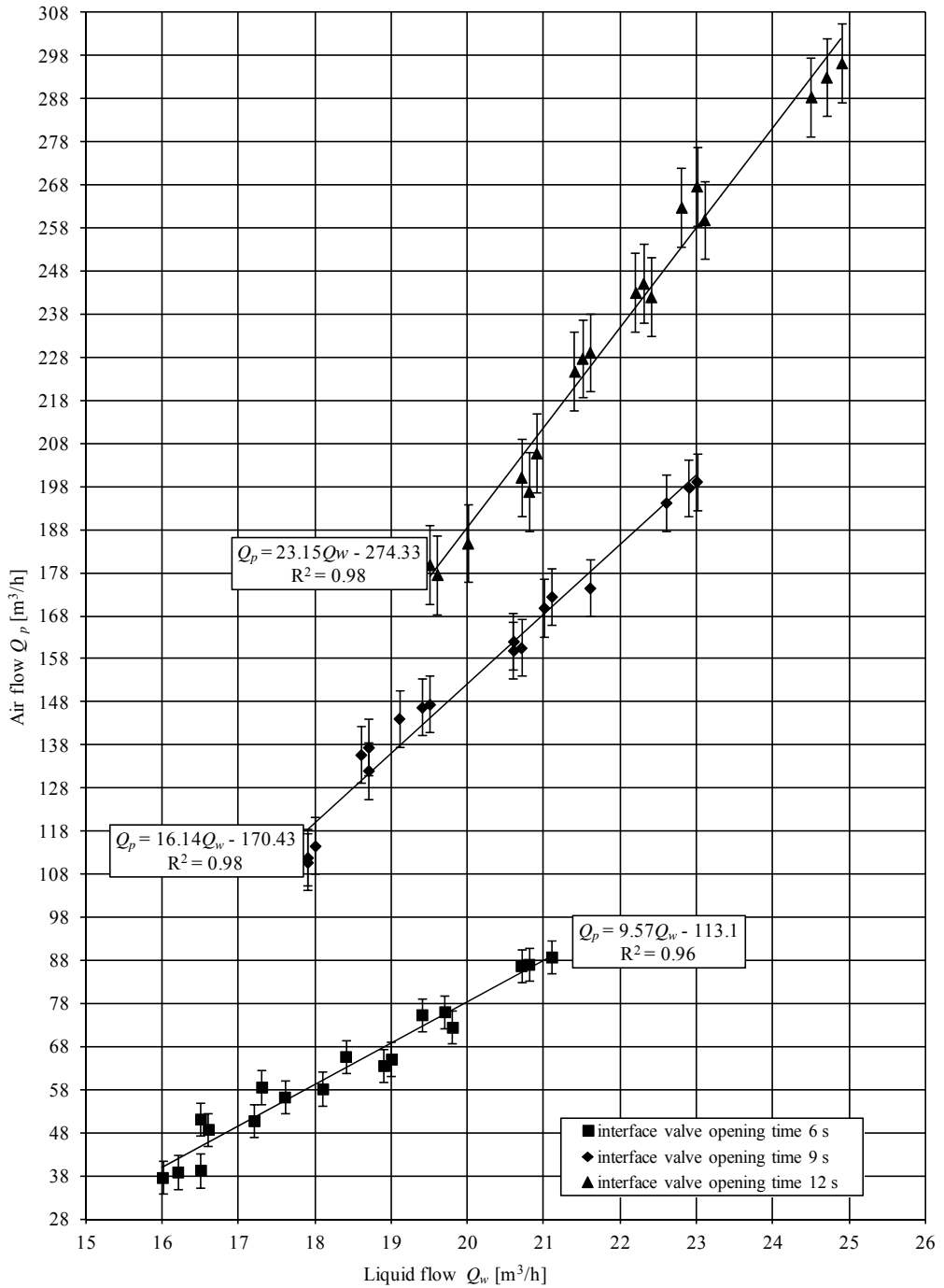

Fig. 6. Air flow vs. liquid flow

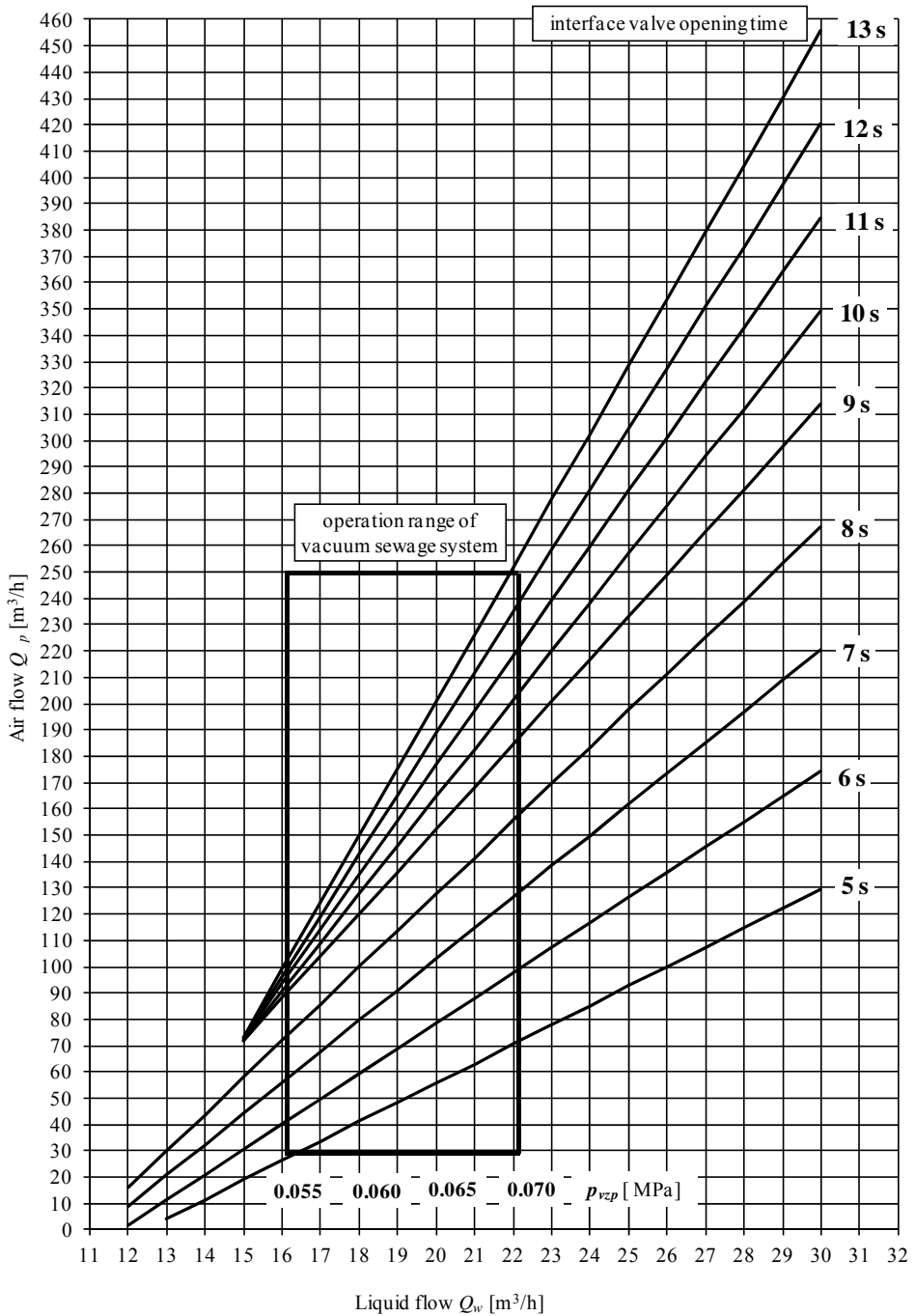

Fig. 7. Interface valve flow capacity for various opening times

The coefficient of determination from the R^2 test for individual trend lines is higher than 0.96; this means that the air flow Q_p depends in more than 96% on the liquid flow Q_w and on the opening time t of the interface valve, and less than in 4% on other factors. On account of this, there were determined empirical formulas (given in Fig. 6) to calculate the air flow Q_p . Then, using the determined formulas (Fig. 6) and the principle of interpolation of contour lines, a nomogram was constructed (Fig. 7) to calculate the air and liquid flow in dependence on the valve opening time t and the underpressure existing in the vacuum vessel. A rectangle marked on the nomogram denotes a work range of the vacuum sewage system.

5. CONCLUSIONS

- In unsteady flow conditions, the interface valve flow capacity depends on the underpressure on vacuum vessel and the valve opening time.
- If the valve opening time increases, the liquid flow Q_w through the vacuum knot increases only slightly, however the air flow Q_p increases significantly.
- The coefficient f describing the air-liquid flow ratio (Q_p/Q_w) increases proportionally to the interface valve opening time.
- The nomograms worked out to determine the coefficient f and flow capacity of the interface knot will make easier a design process and exploitation of the RoeVac type vacuum sewage systems.

REFERENCES

- [1] PN-EN 1091. *Vacuum sewerage systems outside buildings*, PKN, 2002 (in Polish).
- [2] BŁAŻEJEWSKI R., MATZ R., *Design flows for pressure sewers*, Environ. Prot. Eng., 2012, 38 (2), 157.
- [3] TCHISKHOLM D., *Two-phase flows in pipelines and heat exchangers*, Nedra, Moscow 1986 (in Russian).
- [4] DOLECKI J., *Principles of hydraulic calculations of pipelines to the transport of sewage in the arrangement of mixture liquid-gas*, Gaz, Woda i Tech. Sanit., 1983, 57 (9), 282 (in Polish).
- [5] DUKLER A.E., HUBBARD M.G., *A Model for Gas-Liquid Slug Flow in Horizontal and Near Horizontal Tubes*, Indus. Eng. Chem. Fund., 1975, 14 (4), 337.
- [6] DUKLER A.E., MOYE WICKS III, CLEVELAND R.G., *Frictional Pressure Drop in Two-Phase Flow: B. An Approach Through Similarity Analysis*, Amer. Inst. Chem. Eng. J., 1964, 10 (1), 44.
- [7] HUGHMARK G.A., *Pressure Drop in Horizontal and Vertical Concurrent Gas-Liquid Flow*, Ind. Eng. Chem. Fund., 1963, 2 (4), 315.
- [8] HUGHMARK G.A., *Holdup in gas-liquid flow*, Chem. Eng. Progress, 1962, 58 (4), 62.
- [9] HUGHMARK G.A., PRESSBURG B.S., *Holdup and Pressure Drop with Gas-Liquid Flow in a Vertical Pipe*, Amer. Inst. Chem. Eng. J., 1961, 7 (4), 677.
- [10] LOCKHART R.W., MARTINELLI R.C., *Proposed Correlation of Data For Isothermal Two-Phase, Two-Component Flow in Pipes*, Chem. Eng. Prog., 1949, 45 (1), 39.
- [11] MAMAYEV V.A., ODISHARIYA G.E., KLANCHUK V.O., TOCHEIN A.A., SEMENOV N.I., *Flows of gaseous mixtures in pipelines*, Nedra, Moscow 1978 (in Russian).

- [12] UOLLIK G., *One-dimensional two-phase flows*, Izd. Mir, Moscow 1986 (in Russian).
- [13] KALENIK M., *The hydraulic working conditions of the vacuum sewerage system*, Gaz, Woda i Tech. Sanit., 2004, 77 (4), 125 (in Polish).
- [14] KALENIK M., *Empirical formula to calculation of pressure drop in pipelines of vacuum sewerage system*, [in:] J.M. Sawicki, K. Weinerowska, *The hydraulics of transitive systems of the sanitary engineering*, Monographic Notebook No. 2, Wyd. AGNI, Gdańsk 2006, 89–99 (in Polish).
- [15] KALENIK M., *Experimental investigations of hydraulic resistance on lifts in pipelines of a vacuum sewage system*, Environ. Prot. Eng., 2008, 34 (3), 59.
- [16] KALENIK M., *Unconventional sewerage systems*, Wyd. SGGW, Warsaw 2011 (in Polish).
- [17] Roediger, *RoeVac vacuum sewerage systems*, Catalogue, 2004.
- [18] ATV – DVWK, Worksheet A 116, Part 1, *Vacuum drainage outside of buildings*, GFA, April 2004.