

TECHNICAL NOTE

OUTLAYS ON CONSTRUCTION OF AIRPORT RUNWAYS WITH PRESTRESSED AND DOWELLED PAVEMENTS

ANDRZEJ WIĘCKOWSKI

AGH University of Science and Technology, Department of Geomechanics,
Civil Engineering and Geotechnics, Kraków, Poland.
E-mail: awiecko@agh.edu.pl

ALICJA SZNURAWA

Cracow University of Technology, Faculty of Civil Engineering, Kraków, Poland.
E-mail: alisznurawa@gmail.com

Abstract: For two variants of runways with abrasive concrete pavements in the prestressed and dowelled technologies, analyses have been presented regarding labour, materials, use of machinery, and financial outlays, together with the necessary technological-organisational analyses and assessment of work execution cycles, by the example of construction of a runway at the Katowice Airport.

Key words: *dowelled runway, prestressed concrete, technology and organization of construction*

1. INTRODUCTION

At present, in the conditions of accelerated development of air transport, at most Polish airports, new runways are being built, and the existing ones are

extended. The need for accepting and dispatching often intercontinental aircraft with wing span up to 65 m, with heavy weights on touchdown, reaching over 400 tonnes (Boeing 747-400 or Airbus A340) [1], [2] causes a demand for reinforced runways, [3], [4], [7], [12]. As a result, the volumes of concrete and



Fig. 1. New runway at the Katowice Airport built in 2014, [16]

steel built into runways are currently very large, [8, 10]. Reduced consumption of such materials, according to the calculations in [11], [13], [14], allows for application of improved concrete and abrasive prestressed slab pavements, which are much thinner than dowelled concrete slabs.

Two variants of such a runway have been analysed: in prestressed technology – variant I, and in dowelled technology – variant II. After the analysis of the occurring technological-organisational conditions at the construction site, and according to the even work method, work cycles have been determined, [5], [6], and on the basis of the developed investor's cost estimates the effectiveness of the analysed technical solutions has been assessed due to labour R , materials M , use of equipment S , as well as costs.

In the context of actual construction of the runway at the Katowice-Pyrzowice airport, Fig. 1, the technology of prestressed abrasive pavement has been analysed, pointing to executive solutions, with the necessary specialist equipment for execution of core concrete works. For both variants of runway construction, the variability of outlays and costs has been analysed, and work cycle has been assessed.

2. STRUCTURAL CHARACTERISTICS OF THE ANALYSED RUNWAYS

The analysis involved two structural solutions for the runway, on the basis of calculations in [11], [14], Fig. 2:

- variant I: runway with abrasive prestressed concrete pavement,
- variant II: runway with dowelled concrete pavement.

According to the description in [11], runway (27-09) with classification number PCN 64/R/B/W/T, for an airport with reference code 4E, should have the

length of 3,600 m and the width of 45 m, with shoulders of 7.5 m in width, on each side, for aircraft touching down with wing span within the range of 52–60 m and total span of outer landing gear 9–14 m.

In both variants, the runway is set at the depth of 1.20 m below the ground surface.

Subgrade of the runway comprises three layers: gravel, sand-gravel mix, and concrete subgrade (class C15/20). For execution variants I and II, from the bottom, layer thicknesses shall be, respectively: 50 cm, 25 cm, 25 cm and 30 cm, 25 cm, 25 cm. In the case of prestressed runway, subgrade layers are separated from the surface slab with a sliding layer of PE foil (three layers of 0.2 mm in thickness each), while in the case of dowelled runway, there is additionally bituminous mass.

Abrasive (pavement) slab has been designed of concrete: compressive strength of C45/55, flexural strength F6,5, freeze resistance F150 and absorbability below 5%. For exposure class XF4, reinforcement covers amount to 60 mm for surfaces adjacent to external environment, and 30 mm for surfaces on the side of subgrade concrete.

Variant I assumes that thickness of prestressed slab amounts to 25 cm. The runway has been divided into 30 slabs, Fig. 3 (differentiating three types: two slabs – type I, with dimensions 119 m × 45 m, six slabs – type II, with dimensions 118 m × 45 m, all for maximum load, other 22 slabs – type III, with dimensions 118 m × 45 m, for load reduced by 40%). Between the prestressed slabs, there are jacking gaps (29 items) with the width of 2 metres. They allow, first, for cable stretching, and joints made on their edges as a target will compensate for expansion of prestressed elements.

Prestressing tendons of $7\phi 5$ mm in HDPE jackets have been applied ($f_{pk} = 1860$ MPa) grouped by four strands laid in both directions. The tendons have been placed on supports of $\phi 6$ rods with spacing not greater

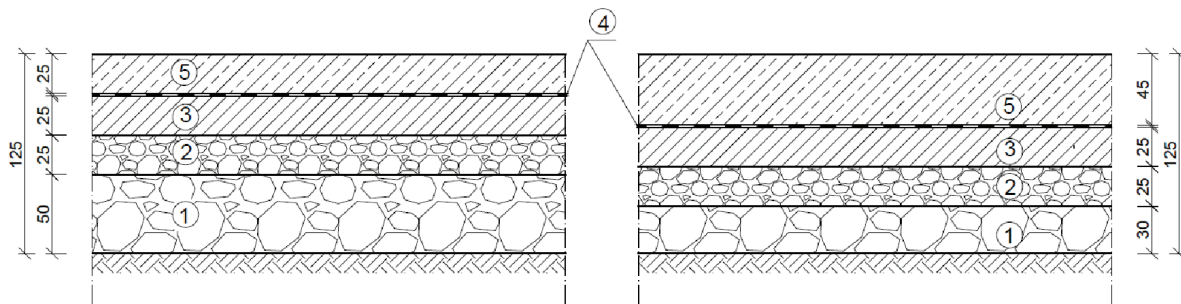

Fig. 2. Fragments of runway cross-section, (a) in prestressed technology, variant I, (b) with dowelled concrete structure – variant II, where 1 – gravel, 2 – sand-gravel mix, 3 – concrete subgrade, 4 – sliding layer, 5 – surface layer [own study]

than 100 cm. The slab features circumferential reinforcement of rods $\phi 12$, of RB500W steel, with spacing of 25 cm and spacer bars $\phi 8$ with spacing of 45 cm. Dowelling of slab edges has been applied with $\phi 20$ dowels of 90 cm in length, placed between anchorages of prestressing tendons, with spacing from 30 cm to 50 cm, Fig. 4.

Variant II assumes the structure of the runway with a dowelled concrete pavement (without prestressing tendons) of concrete as for the prestressed slab, with the thickness of 45 cm. In the execution aspect, the slabs have dimensions of 45 m \times 45 m, which are then divided into smaller slabs, with dimensions of 9 m \times 9 m.

The slab is reinforced at the bottom with the rods of $\phi 16$ every 20 cm along, and every 25 cm across. At the top, structural reinforcement $\phi 12$ has been applied every 25 cm in both directions. Dowelling is done for slabs with dimensions 9 m \times 9 m spaced every 30 cm.

3. ELEMENTS OF TECHNOLOGY AND WORK ORGANISATION

A condition for the success of execution of such an important task as construction of a runway is the good

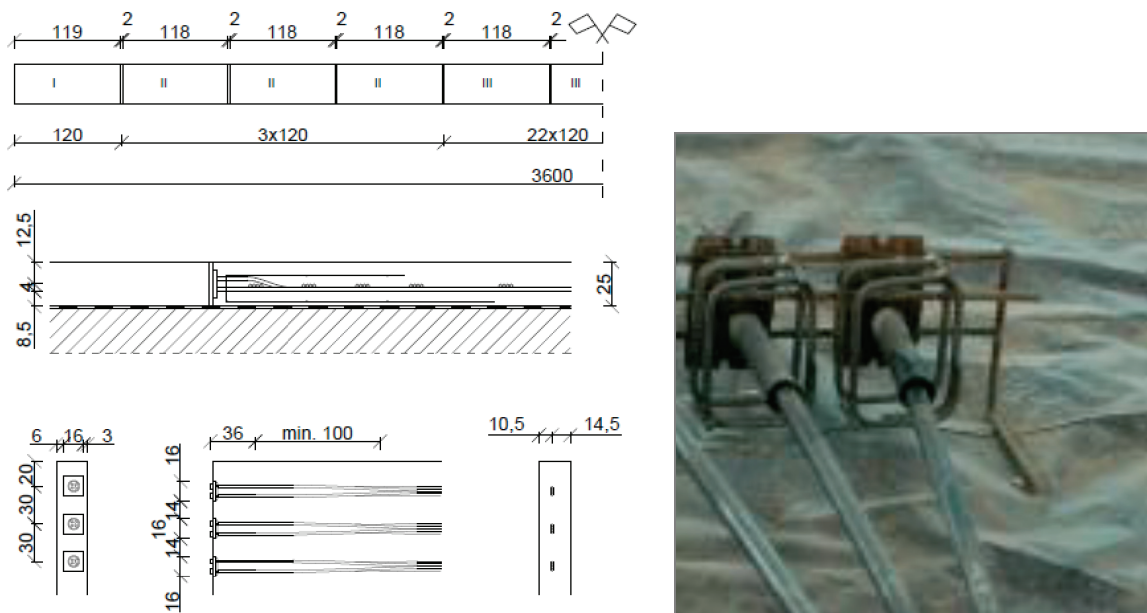

Fig. 3. Division of prestressed slab into sections, acc. to load types I, II and III, and detail of connecting prestressed slabs with a jacking gap, and a view of preliminary stabilised tendon terminals, dimensions in cm, descriptions in the text [own study, photo by A. Seruga]

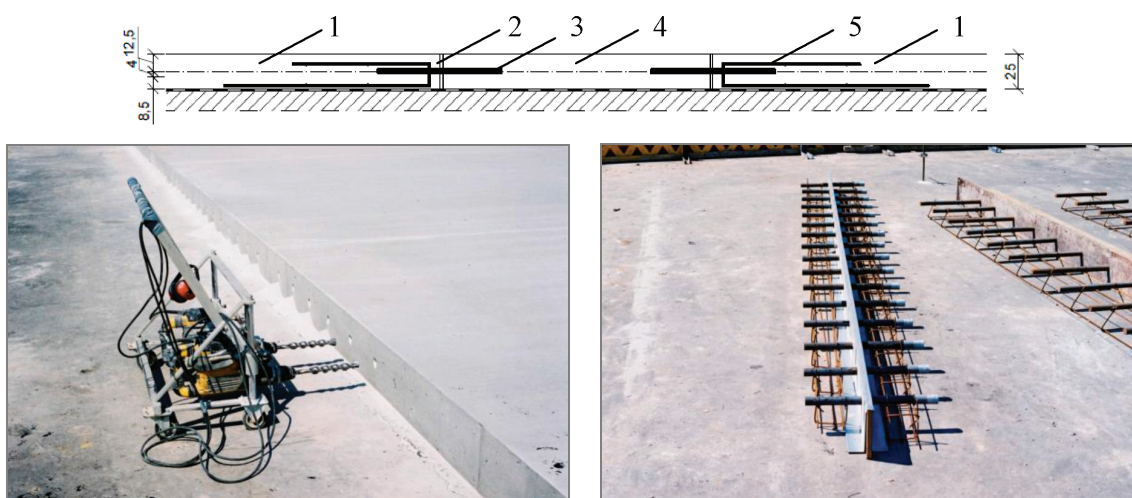

Fig. 4. Detail of dowelled slab connection and a drill for openings, as well as prefabricated joint elements with dowels [own study, photo by A. Seruga]

engineering of both technology and organisation of the works. Below, there are selected elements of executive solutions to condition correct execution, in this case difficult concrete works, due to high quality requirements and concrete class C45/55, and due to the need for assuring very high intensity of mix laying and accuracy of the works.

3.1. TEMPORARY ROAD

According to the guidelines for the project, construction works shall be commenced after prior removal and replanting in other places of natural habitats comprising wild bushes growing on the territory of the planned investment.

The task is very large, as only upon the construction of the new runway the volume of soil to be removed totals approximately 280,000 m³. Similar volume of materials, with usually greater densities, must be supplied for building in. Assuming a one-year cycle of task execution and eight-hour workdays, as well as transports with lorries with total weight of 40 tonnes, with transport irregularity coefficient equivalent to 2, average transport intensity totals approximately 1.4 lorry per minute.

The transport route is long, over 3 km. Moreover, there is a need for periodical stoppages of lorries at work sites, hence in order to preserve traffic liquidity, it is necessary to have a two-lane temporary road for the period of the construction. After removal of the vegetable earth layer, on the compressed sand mix with a thickness of 10 cm (levelled with cross-fall of 1% outside the constructed runway) road with a thickness of 6 m has been designed of reinforced-concrete slabs with dimensions of 300 cm × 300 cm × 15 cm.

3.2. CONCRETE LAYING CONDITIONS

Pursuant to PN-EN 206-1:2003 Concrete – Part 1, [9], it is assumed that in order to achieve monolithic connection of the mix laid (added) and previously executed, simultaneous compaction is necessary of the mix laid with at least 8 cm thickness adjacent to the prior portion of the mix. Certainly, compaction (and possible smoothing and finishing of the surface) must be finished before cement setting starts, in each portion. In other words, in order to achieve monolithic connection of the portion of the mix laid at present and previously, joint compaction of the mix must be finished, in each place, on the entire surface of adjacent portions still before the start of cement setting.

Therefore, in order to achieve monolithic connection, time t_w^k – completion of building in any portion of the mix k must meet the condition [15]

$$t_w^k \leq \min(t_{pw}^k, t_{pw}^{k+1}), \quad k = 1, 2, \dots, n-1, \quad (1)$$

where t_w^k, t_w^{k+1} – times of commencement of cement setting, respectively, in portion k laid earlier, and in added portion $k+1$.

While calling the mix working period τ_u^k – the time period calculated from moment t_0^k – cement working with water in the prepared portion k , until completion of all activities related to building in this portion of the mix as above until moment t_w^k , the following can be written

$$\tau_u^k = t_w^k - t_0^k, \quad k = 1, 2, \dots, n. \quad (2)$$

In contractor works, the working period τ_u^k refers to the entire portion k , formed by the supplied mix, e.g., in one concrete mixing vehicle. Therefore, the period is calculated from the moment of cement sprinkling with water in the first working mix prepared (upon mixing the first feed from the concrete mixing vehicle), and τ_u^k comprises: period of mixing and loading of all mixes transported together, in one concrete mixing vehicle, next the transport duration, later total period of feeding and execution of all activities upon mix building-in, until natural completion, including the periods of awaiting and stoppages occurring in each of the aforementioned storage periods.

3.3. CONCRETE MIX PREPARATION

At present, preparation of mixes usually occurs in centralised concrete plants, hence their location against the construction site is very important, as well as short and uninterrupted delivery time. At the analysed construction site, a major problem involves the need of guaranteeing mixes of very high quality, in significant volumes, assuring high efficiency of deliveries, of over 150 m³/h.

The subgrade layer of concrete class C15/20, with the thickness of 25 cm, width of 60 m, must involve approximately 54,000 m³ of the mix. Special concrete for abrasive layer, as above of class: C45/55, F6,5, F150, with absorbability below 5%, slab thickness of 25 cm or 45 cm, must be supplied in the volume, respectively, for prestressed pavement approximately 40,500 m³ or 72,900 m³ for dowelled pavement (actu-

ally executed: subgrade of concrete C15/20, thickness 22 cm and abrasive layer of cement pavement concrete C35/45, thickness 30 cm).

Such a significant demand for the mix and specially high quality requirements justify the need to assure specialist, very efficient node for production of concrete mixes at the construction background. The conditions are currently met by the available, also mobile nodes for production of concrete mix with programmable automatic control of cyclical operation of particular device assemblies, namely dosing (simultaneous weighing/measuring of basic components of the mix and additives and admixes), their transport and feeding to the mixer, controlled mixing and unloading. Naturally, with the execution of continuous laboratory analyses, according to the schedule and dispatch documentation, with full production monitoring and data archiving.

In this case, a batching plant is necessary with a very high operating efficiency of above 150 m³/h. It is possible to use plants with one or two concrete mixers. A single plant, Fig. 5a, which was actually used at the background of the construction site in Pyrzowice, with the yield rate of over 200 m³/h, satisfies the demand for concrete mix. The concrete mixer applied, with the weight of over 10 tonnes, with batch capacity of 6 m³, engine power 2 × 75 kW, equipped with two mixing counter-rotation shafts, with synchronised revolutions against one another, with mixing blades generating severe material turbulence (particularly in the mixer interlocking zone) causing loosening and aeration of the materials mixed, and food spreading of cement on the aggregate surface. The rotational movement of angled arms and blades of the mixers simultaneously causes shifting of the material horizontally, at the entire length of the mixer, and achievement of very good homogenisation of components, across the volume of the batch, in the small time period. Exemplary

diagram of the variability of component homogenisation degree in the prepared concrete mix during mixing is illustrated in Fig. 5b.

Due to the danger of failure and at the same time the need for guaranteeing continuity of mix building, particularly when executing prestressed pavement, a reserve concrete plant must be accounted for in the concrete laying periods, with the necessary efficiency and tested quality of the mix produced. In the event of problems with availability of the reserve concrete plant (due to a remote location), a more favourable solution involves a symmetrical batching plant, double (with two separate, the same mix production lines, e.g., two two-shaft concrete mixers with weights of over 2 × 6.5 t, engine power 2 × 2 × 36.5 kW, with batch capacities of 2 × 3 m³, with capacity of over 2 × 100 m³/h, with alternative power supply).

An important element is to assure timely supply of large volumes of basic mineral raw materials, usually several fractions of fine aggregates (2÷3, washed sands), and several fractions of coarse aggregates (2÷3, hard rock chippings, e.g., of granite, basalt) and cement, straight from the cement plant. The mix can be produced and built into the runway exclusively after positive result of the properties of the concrete manufactured, to the 1 : 1 scale, at the test section.

3.4. ACTUAL EXECUTION OF THE ABRASIVE LAYER OF THE RUNWAY

At the Katowice Airport, after execution of the excavation with soil removal, and making layers of coarse and fine chippings according to the technology of roadworks [6], and then layer of concrete subgrade class C15/20, attention must be drawn to the execution of the abrasive layer of the runway.



Fig. 5. Concrete plant for the purposes of extending the Katowice-Pyrzowice airport (a) [17], and (b) interdependence of mix homogenisation in %, on the mixing time in seconds, in two-shaft mixers MB [18]

In the case of a concrete abrasive pavement (here: without reinforcement inserts), the works could be executed with the application of a band layer formed of a complex of three specialist machinery components, Fig. 6a. In that case, the concrete mix supplied with tripping trucks is evenly spread by the excavator bucket at the entire width of the band made, just in front of the laying machine, Fig. 6b. Next, the moving first component of the laying machine evens the layer, compacts the mix with deep-through vibrators placed at the entire working width, and then additionally compacts and evens the top layer with the beam. Another component of the laying machine presses the set of steel dowels into the fresh mix and places in the planned places (on the entire width of the band, under the later expansion joints), Fig. 6c. The third component cuts off excess mix, compacts it from the top and levels it. Mechanical vibratory screed smoothens the surface and the brush makes cross cracks, while the sprinkling system places the chemical agent forming a waterproof surface to prevent water evaporation, Fig. 6d.

This is the manner of executing the abrasive pavement of cement concrete C35/45, thickness 30 cm, at

the Pyrzowice airport. The pavement of the width of 45 m was made in six passes of the laying machine, executing four bands of 9 m in width and two bands of 4.5 m in width, Fig. 6e. Average speed of band laying totalled about 40 m per hour.

3.5. WORKS EXECUTION IN THE ANALYSED SOLUTIONS FOR ABRASIVE SURFACE

In the case of an abrasive pavement with prestressed structure – variant I, there is a need for spacing and accurate placement of many tendons and reinforcement inserts before concrete laying on the element. Moreover, there is a need for making a large slab as monolithic, with the area of 45 m of width and length of 119 m or 118 m. Such conditions significantly affect the applied technology of the works.

After forming the edges of the slab on its entire circumference, and placement and stabilisation of prestressing cables and reinforcement inserts, mix feeding must occur from the outside of the surface where con-



Fig. 6. Construction of a concrete abrasive layer of runway in Pyrzowice, (a) view of 3 parts of band laying machine and excavator, and consecutive concrete laying phases: (b) concrete mix supplied for preliminary spreading with the excavator, (c) element of second part of the spreader placing dowels at the width of the band made, (d) waterproof layer sprinkling system, – view of laying the second band of abrasive surface [own study, on the basis of [17]]

crete is laid. For concrete laying, specialist vehicle-mounted conveyor belt can be used, or a mobile pump of the largest type, with large reach and throughput.

Among others, due to thick-plastic consistence of the concrete mix and much lower demand for energy, it is more favourable to use a large-size vehicle-mounted conveyor belt, e.g., Telebelts TB 200, Fig. 7, with the following parameters of horizontal feed: theoretical capacity: 300 m³/h, main telescope conveyor belt, full-rotational horizontally (360°), minimum range 24 m, maximum 61 m, feed conveyor of 22.1 m in length with support span of 8.9 m along the movement axis, and 8.3 m across, engine power 330 kW, total weight 107.6 t.

Concrete mix can be supplied by both vehicle-mounted concrete mixers, and tripping trucks.

The feed conveyor with chute and support wheels, at the end, allows for simultaneous unloading of two or three vehicle-mounted concrete mixers (in this case two concrete mixers while unloading set back to back, at one lane of the temporary road). Concrete mixers

shall unload the mix through chutes to the side, to the chute of the feed conveyor. At the vehicle column, the mix from the feed conveyor is lowered, through the chute, to the main conveyor by which it is transported to the end of the conveyor and fed by the chute to the build-in place.

In the event of application of a pump for feeding the mix, the supplies shall be made by vehicle-mounted concrete mixers. The pump Putzmeister 6RZ62, with theoretical capacity of 160 m³/h, with a six-segment arm with the horizontal range of 57.1 m can be used, with support span of 12.3 along the movement axis and 12.1 m across, engine power 446 kW, total weight 60 t.

During the operation, the pump is stabilised: at one lane of the temporary road, on two supports with minimum one-side span across and span of such supports of 18.8 m parallel to the movement axis, and on other two supports set at the shoulder of the runway, at full span across, namely with total across support span of 8.3 m, Fig. 8. While feeding the mix, the

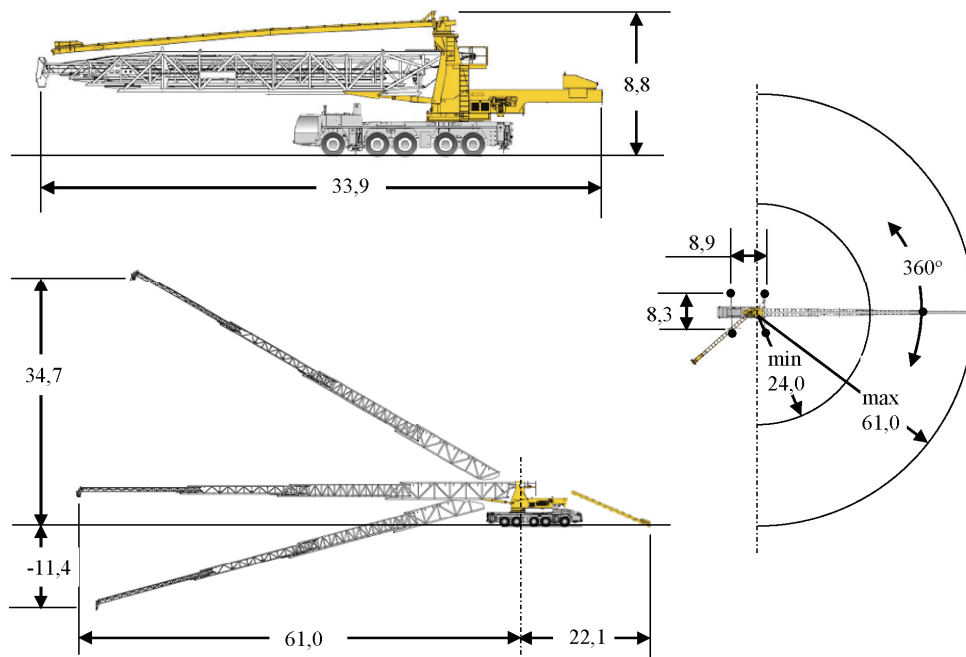

Fig. 7. Selected characteristics of the vehicle-mounted belt conveyor Telebelts TB 200, dimensions in meters [own study, on the basis of [20]]

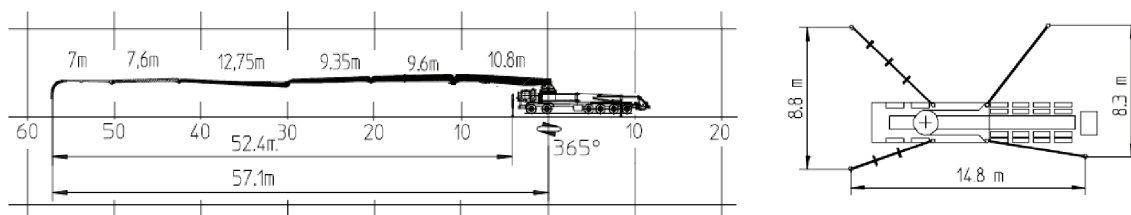

Fig. 8. Selected characteristics of the vehicle-mounted pump for concrete mix Putzmeister 6RZ62 [own study, on the basis of [19]]

pump can have the arm set exclusively to the side of full across support span – otherwise the rotation is to be blocked.

For compaction and levelling of the placed concrete mix and for securing the surface against water evaporation, there is a need for a truss stiff working platform with the span of 46 m over the entire width of the slab made, moving along the prior concrete subgrade of the working runway. Similarly as above, in the case of band laying machinery complex, the mix spread across the slab made, is first compacted with deep-through vibrators and then cut, further compacted and levelled with a multi-segment vibratory screed mounted to the working platform, and smoothed and secured with the layer securing against water evaporation.

In variant II – with the dowelled abrasive surface, execution of monolithic slabs has been assumed with dimensions of 45 m × 45 m, [11]. As a consequence, execution of expansion joints has been assumed every 45 m, with the thickness of 35 mm and filled with a compacting material. Moreover, joints must be performed, dividing the slab into a set of squares of 9 × 9 m.

Cuts are to be made in two phases. For the first time, after concrete has achieved compressive strength of 10 MPa. In practice, this is usually after 8 h to 12 h. The process of first cutting must be completed before 24 h from the end of concrete pumping. The first cut, made with concrete cutting blades, at the depth of 1/3 to 1/4 of slab thickness. The cuts are about 4.0 mm wide. After concrete has achieved compressive strength of 24 MPa, the joints are widened to the designed width. After cuts have been made, the slots must be carefully cleared and filled with pourable sealing compound.

Abrasive pavement of the runway is also to be finished on the surface by grooving with milling cutters for concrete, with diamond edges.

3.6. PRESTRESSING OF C 35/45 CONCRETE SLABS

Initial prestressing begins after concrete has achieved compressive strength equal to 12 MPa (in sample cubes or 10 MPa in sample cylinders, according to EN-206/2000) [9]. In practice, after checking concrete strength, initial prestressing takes place after 24 hours from completion of concrete pumping. First, tendons are compressed lengthwise, and then crosswise. Final prestressing is performed after concrete has achieved compressive strength equal to 24 MPa

(in sample cubes or 20 MPa in sample cylinders). Each slab is prestressed in the same manner. After completion of tendon stretching, anchorage is secured, dowels are installed, and then reinforcement is made and jacking gap is laid with concrete.

4. CONSTRUCTION CYCLES OF STRUCTURAL VARIANTS

When planning the organisation of teams executing particular works, in the context of methods and technological order of works, 8-hour shifts have been planned with 5-day working week, from Monday to Friday inclusive, for all brigades except for prestressing teams. Such teams perform prestressing usually one to eight days after concrete pouring. Hence, they have to work on Saturdays, and sometimes also on Sundays. No additional limitations have been considered, as may be imposed by the airport.

The volume of works is very large. Hence, the brigades usually have double numbers of the same types of the equipment. Similarly, when pouring concrete for prestressed slabs, in order to lay 1,350 m³ of the mix during an 8-hour working shift, as many as two vehicle-mounted conveyor belts or two pumps must operate simultaneously, feeding concrete mix supplied by 21 truck concrete mixers from concrete-mixing plant for the purposes of the site, and possibly from two standby concrete-mixing plants.

The works have been planned according to the uniform work method. Five operating plots have been applied, with section lengths of 600 m (each plot covers the area of 5 prestressed slabs with jacking gaps). In the plans for executing the whole investment, a uniform, three-week rhythm of work has been adopted (with five business days per week). The task execution cycle can be calculated according to the relation [5], [13]

$$t^D = r(m + n - 1), \quad (3)$$

where:

r – rhythm duration, $r = 3$ weeks,

m – number of working processes executed, variant I – prestressed slab, $m^I = 9$, variant II – dowelled slab, $m^{II} = 8$,

n – number of plots, $n = 6$.

After substitution of values to formula (3) and calculation, execution cycles amount to

$$t^I = 42 \text{ weeks (namely 294 calendar days),}$$

$$t^{II} = 39 \text{ weeks (namely 273 calendar days).}$$

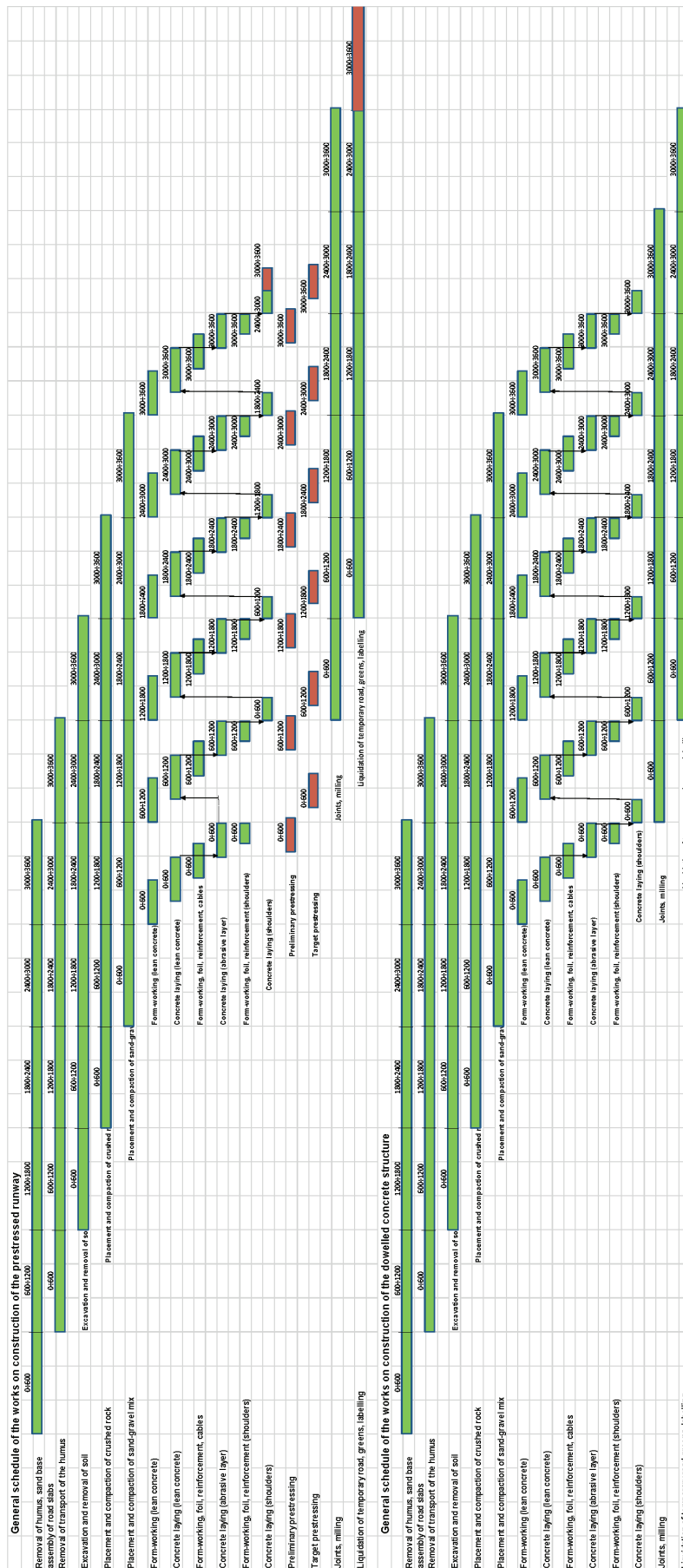

Fig. 9. General schedule of the works on construction of the presented runway and of the dowelled concrete structure

In the case of runway construction according to variant II, there is no prestressing process, hence $m = 8$. Then, the execution cycle is shorter by $r = 3$ weeks, namely by 7% against the cycle of runway construction in the prestressed technology; compare schedule, Fig. 9.

According to the guidelines, before commencement of construction works, natural habitats present in the area of the planned runway must be removed and relocated into other places. The performance of such works prolongs the runway construction cycle by eight weeks (as only after completion and evaluation of works can the runway construction begin). Hence, total investment completion time $t^C = 50$ weeks. In the Polish climatic conditions, works must be commenced in the second half of September, so as to replant the bushes in autumn, while in early spring, immediately after defrosting of soil, to start preparation of temporary roads for the site, and if the temperatures permit it, to carry out earth works and other works.

5. COST ANALYSIS

Cost estimate prices of particular works, as regards the construction of each fragment, and next each complete facility, have been determined according to the relation

$$CK = R + M + S + K_p + K_z + Z + P_V \quad (4)$$

where

R, M, S – direct costs of, respectively, labour, materials and of equipment and technological transport, calculated as products of $L \cdot n \cdot c$, L – number of material units, acc. to bill of quantities, n – unit material outlays acc. to KNR and individual calculation, c – unit prices of production factors acc. to Secocenbud for Q3 of 2012 and individual calculations, assuming labour of 5 €/h,

K_p – indirect costs, $K_p = w_{KP}(R + S)$, w_{KP} – indirect cost factor, $w_{KP} = 0.65$,

K_z – cost of procurement and external transport of materials, $K_z = w_{KZ}M$, w_{KZ} – procurement cost factor, $w_z = 0.12$,

Z – calculated profit, $Z = w_z(R + S + K_p)$, w_z – profit factor, $w_z = 0.1$,

P_V – VAT tax, $P_V = w_V(R + M + S + K_p + K_z + Z)$, w_V – VAT factor, $w_V = 0.23$.

Total cost estimate price, VAT inclusive, for the execution of runway with pavement with prestressed structure, namely according to variant I, amounts to 35.3 M €, Fig. 10. In turn, the execution of the runway with traditional dowelled reinforced concrete structure, namely according to variant II, is valued at 41.7 M €. High price difference, totalling 6.4 M €, results from the change of material outlays, principally as regards structural elements of the runway, namely subgrade and pavement.

The cost estimate price of crushed rock and gravel layers in the case of pavement with traditional dowelled concrete structure amounts to 10.7 M €, and is lower by 2.4 M € than the price of such layers with prestressed structure. This results from different thickness of such subgrade course parts. Respectively, in variant II, crushed rock and gravel layer thicknesses in the subgrade total 55 cm, while in variant I 75 cm.

In turn, there is a significantly greater price difference between variant I and II for the benefit of the prestressed structure for execution concrete subgrade and concrete abrasive pavement (with standard and prestressing reinforcement, applied in particular variants). The cost estimate price (VAT inclusive) of concrete layers, subgrade and pavement of the runway with prestressed structure amounts to 20.6 M €, and is lower by 8.8 M € than the price of such layers with dowelled structure. Such a large difference is principally due to concrete layer of pavement of the runway

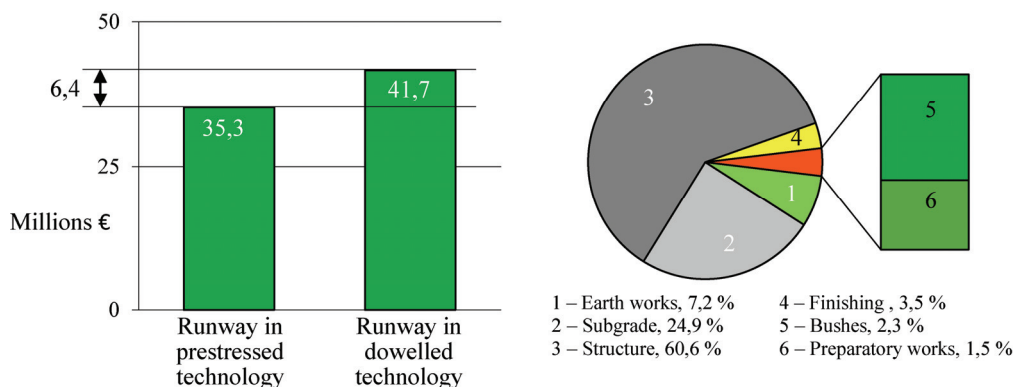

Fig. 10. Total cost estimate prices (VAT inclusive) for execution of the runway and cost structure in the case of prestressed technology [own study]

with traditional structure, which is by 20 cm thicker than the concrete layer of pavement with prestressed structure.

Outlays on labour R , materials M , and operation of equipment S in execution variants are highly differentiated. Labour consumption of the solution with prestressed runway amounts to 465,000 working hours and is greater by 20,900 working hours than in the case of traditional concrete structure. Furthermore, greater precision is required, as well as strict timeliness of all works related to prestressing.

In turn, material consumption of the prestressed pavement is much lower in total, by 110,000 m³ of concrete mix, as compared to the dowelled structure. Also, equipment operation is lesser, by 11,300 machine-hours, including the pumps, by 2,100 machine-hours, than in the case of dowelled structure.

6. CONCLUSIONS

At present, the clearly increasing global demand for civil aviation services, there is a need for many repairs and modernisations, as well as construction of new runways for airplanes.

On the basis of the calculations and analyses of exemplary solutions, acc. to [11], for the runway at Katowice-Pyrzowice airport, against variant II – with abrasive dowelled pavement, variant I – in prestressed technology, is characterised with:

- cost estimate price of runway execution is lower by 18.1%, principally due to lower cost of concrete layers by 42.7%,
- the volume of the in-built concrete mix is much lower, by 32,400 m³ (corresponding to the volume of 4,050 vehicle-mounted concrete-mixers), equipment operation outlays are lower by 11%, while labour input is higher by 4.7% (including the need for specialist prestressing),
- the investment cycle is longer by 7%, and execution of the processes requires greater precision of works and strict following of the work schedule (in particular in the case of prestressing works).

Due to the lower concrete consumption, greater durability [7], [14], lower construction and operation

costs [8], [13], abrasive pavements in prestressed technology should be taken into account as first, before dowelled surfaces.

REFERENCES

- [1] *Airplane characteristics for airport planning*, 747-400. Airplane characteristics for airport planning, May 2012.
- [2] *Airport Pavement Design and Evaluation*, Advisory Circular, U.S. Department of Transportation, Federal Aviation Administration, 2009.
- [3] *Concrete floor slabs on grade subjected to heavy load*, UFC, Department of Defense, 2005.
- [4] *Design of post-tensioned slabs-on-ground*, PTI Phoenix, Arizona 2005.
- [5] JAWORSKI K.M., *Podstawy organizacji budowy*, Wydawnictwo Naukowe PWN, Warszawa, 2004.
- [6] MARTINEK W., NOWAK P., WOYCIECHOWSKI P., *Technologia robót budowlanych*, Oficyna Wydawnicza Politechniki Warszawskiej, Warszawa 2010.
- [7] NITA P., *Betonowe nawierzchnie lotniskowe. Teoria i wymiarowanie konstrukcyjne*, Wydawnictwa Instytutu Technicznego Wojsk Lotniczych, Warszawa, 2008.
- [8] NITA P., *Budowa i utrzymanie nawierzchni lotniskowych*, Wydawnictwa Komunikacji i Łączności, Warszawa, 2008.
- [9] PN-EN 13877-1. *Concrete pavements. Part 1: Materials*.
- [10] Report No. FHWA/TX-04/0-4035-1: *Design of a post-tensioned prestressed concrete pavement, construction guidelines, and monitoring plan*. The University of Texas at Austin, 2003.
- [11] SZNURAWA A., *Zagadnienia konstrukcyjno-technologiczne dotyczące projektowania betonowych nawierzchni lotniskowych*, Praca magisterska, Politechnika Krakowska, Kraków 2012.
- [12] SZYDŁO A., STAROSOLSKI W., *Konstrukcje żelbetowe według Eurokodu 2 i norm związanych*, Vol. 3. PWN, Warszawa, 2012.
- [13] WIĘCKOWSKI A., SZNURAWA A., *Effectiveness of concrete runways construction on the eve of air transport domination*, Creative Construction Conference, Hungary, Budapest, 2013.
- [14] WIĘCKOWSKI A., SZNURAWA A., *Structural aspects of airfield runways with concrete pavements*, Studia Geotechnica et Mechanica, Wrocław, 2015.
- [15] WIĘCKOWSKI A., *Transport mieszanki betonowej*, Politechnika Krakowska, Kraków, 2013.
- [16] <http://www.dziennikzachodni.pl/artykul/zdjecia/3724626,katowice-airport-pierwszy-samolot-na-nowej-drozdze-startowej-w-kwietniu,4784762,id,t,zid.html>
- [17] <http://www.katowice-airport.com>
- [18] <http://www.mieszalnikiwloskie.pl>
- [19] http://pompbet.pl/dokumenty/dane_techiczne_putzmeister_62.pdf
- [20] <http://www.putzmeisteramerica.com/products/telebelts>