



P 186

m

LEHRBUCH
DER
AUFBEREITUNGSKUNDE

VON

P. RITTER VON RITTINGER

ATLAS

XXXIV TAFELN

1913. 1375.

BERLIN
VERLAG VON ERNST & KORN
(GROPIUS'SCHE BUCH- UND KUNSTHANDLUNG)
MDCCCLXVII

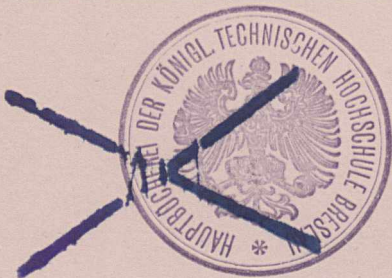

Jan. 23. 17.



Verzeichnifs der Figurentafeln.

<p>Tafel I Figur 1 bis 19</p> <p>- II - 20 - 30</p> <p>- III - 31 - 43</p> <p>- IV - 44 - 55</p> <p>- V - 56 - 70</p> <p>- VI - 71 - 84</p> <p>- VII - 85 - 101</p> <p>- VIII - 102 - 111</p> <p>- IX - 112 - 116^b</p> <p>- X - 116^c - 117</p> <p>- XI - 118 - 121</p> <p>- XII - 122 - 134</p> <p>- XIII - 135 - 146</p> <p>- XIV - 147 - 156</p> <p>- XV - 157 - 160</p> <p>- XVI - 161 - 166</p> <p>- XVII - 167 - 176</p>	<p>Tafel XVIII Figur 177 bis 184</p> <p>XXIX - 185 - 198</p> <p>XX - 199 - 200</p> <p>- XXI - 201 - 203</p> <p>- XXII - 204 - 214</p> <p>- XXIII - 215 - 220</p> <p>- XXIV - 221 - 223</p> <p>- XXV - 224 - 225</p> <p>- XXVI - 226 - 228</p> <p>- XXVII - 229 - 236</p> <p>- XXVIII - 237 - 243</p> <p>- XXIX - 244 - 251</p> <p>- XXX - 252 - 258</p> <p>- XXXI - 259 - 263</p> <p>- XXXII - 264 - 268</p> <p>- XXXIII - 269 - 272</p> <p>- XXXIV - 273 - 278</p>
---	---

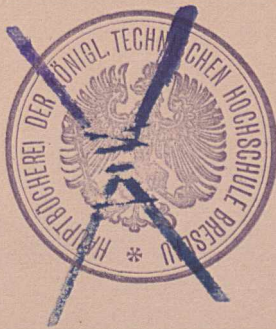

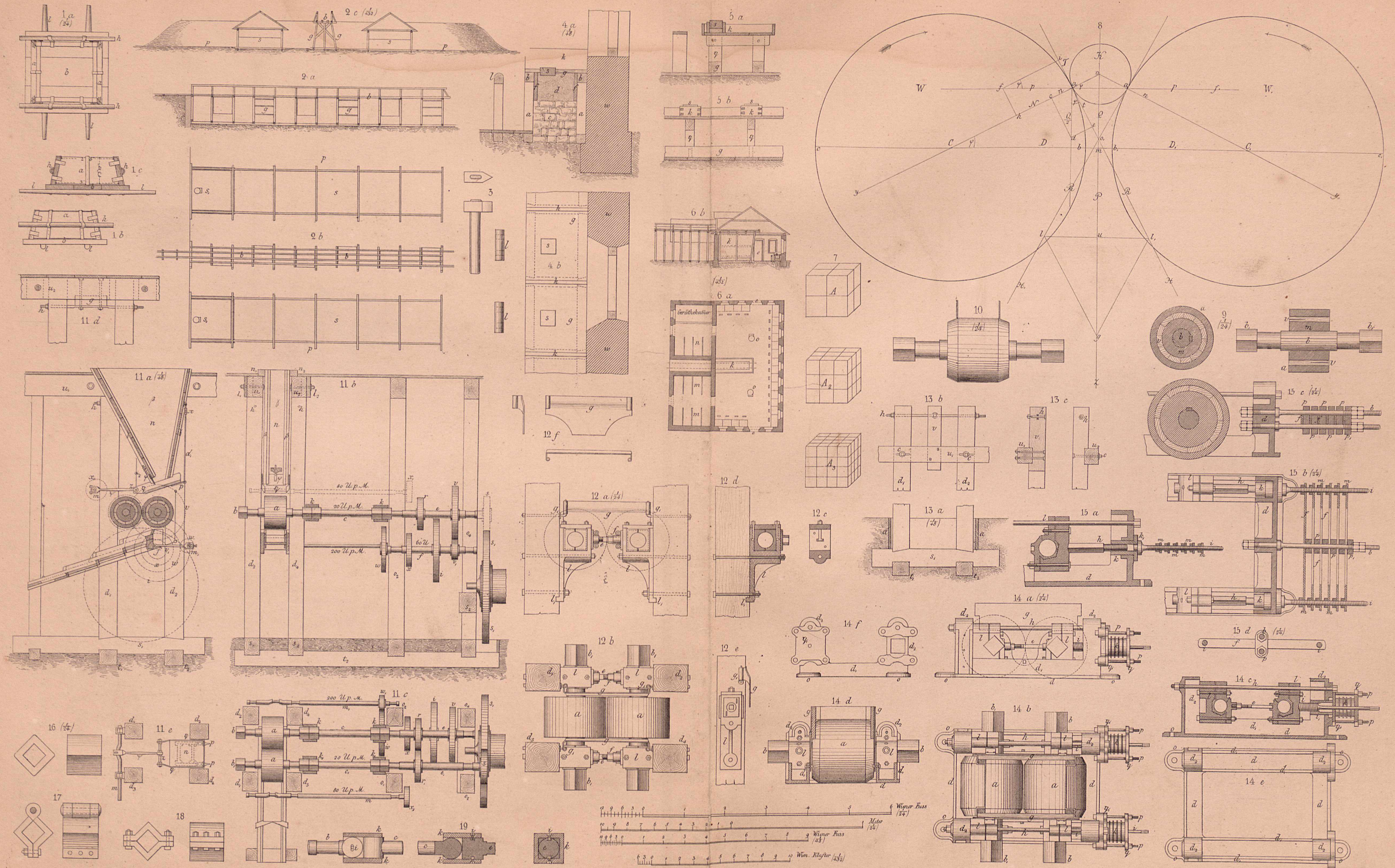

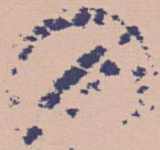
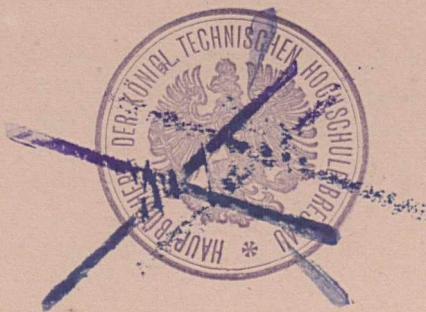

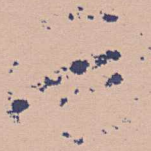
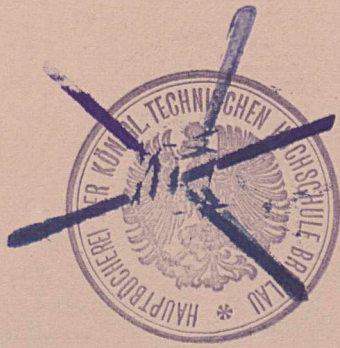

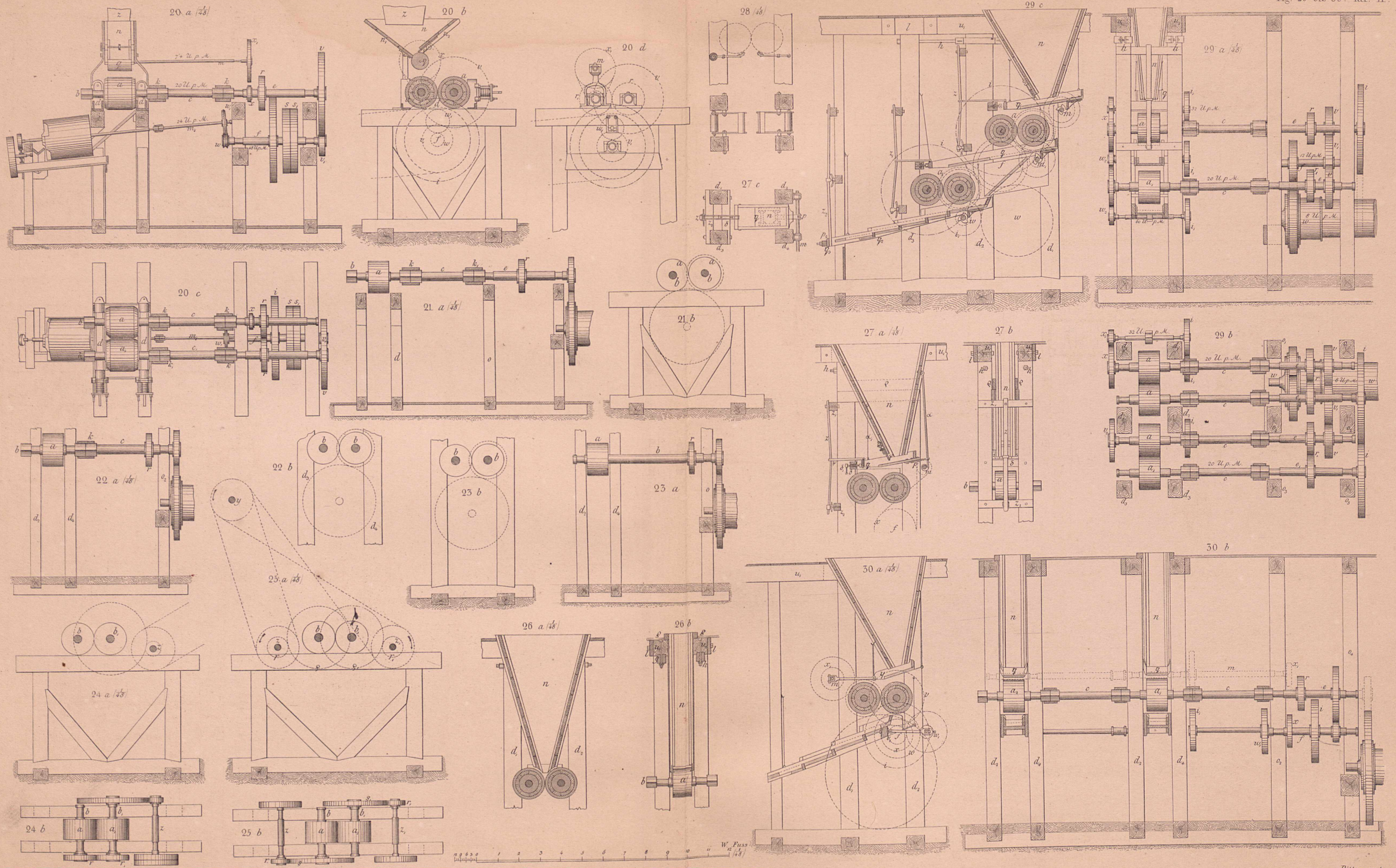

W. F. 148

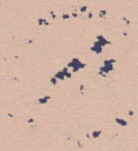
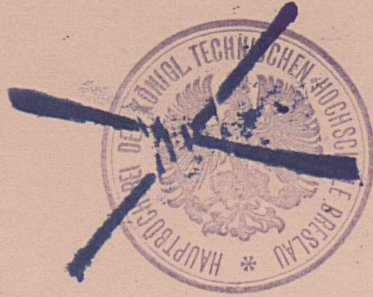

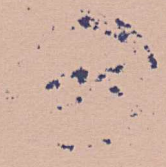
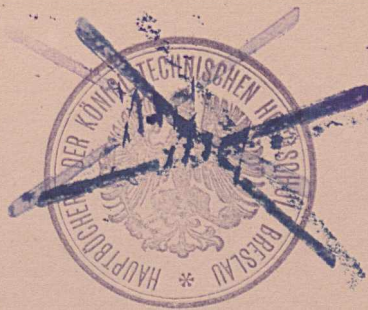

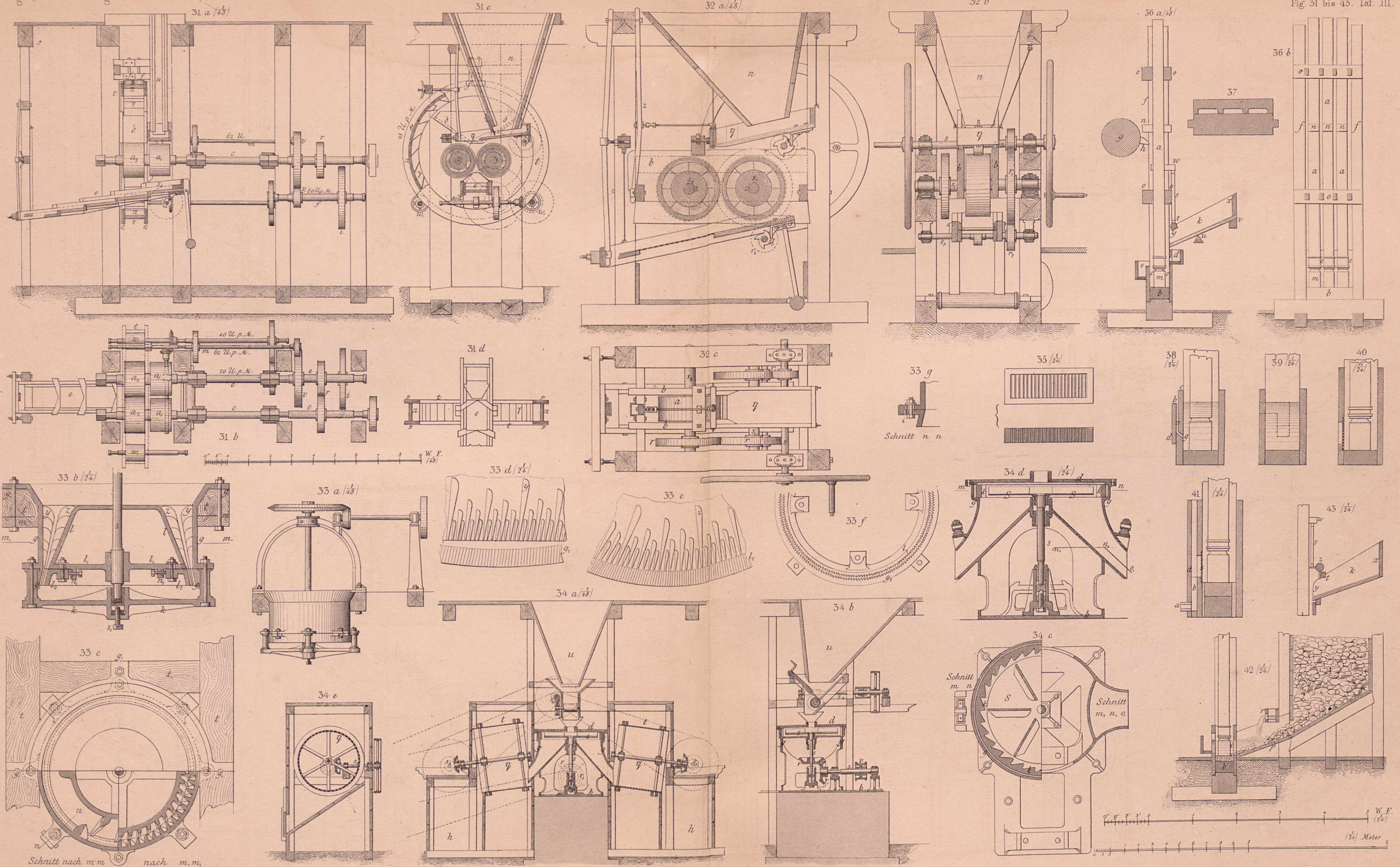

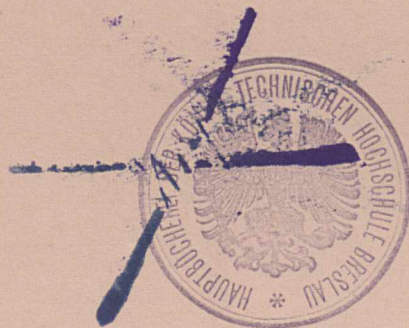

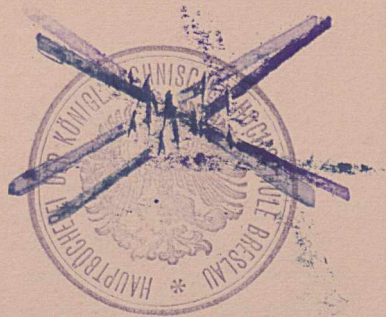

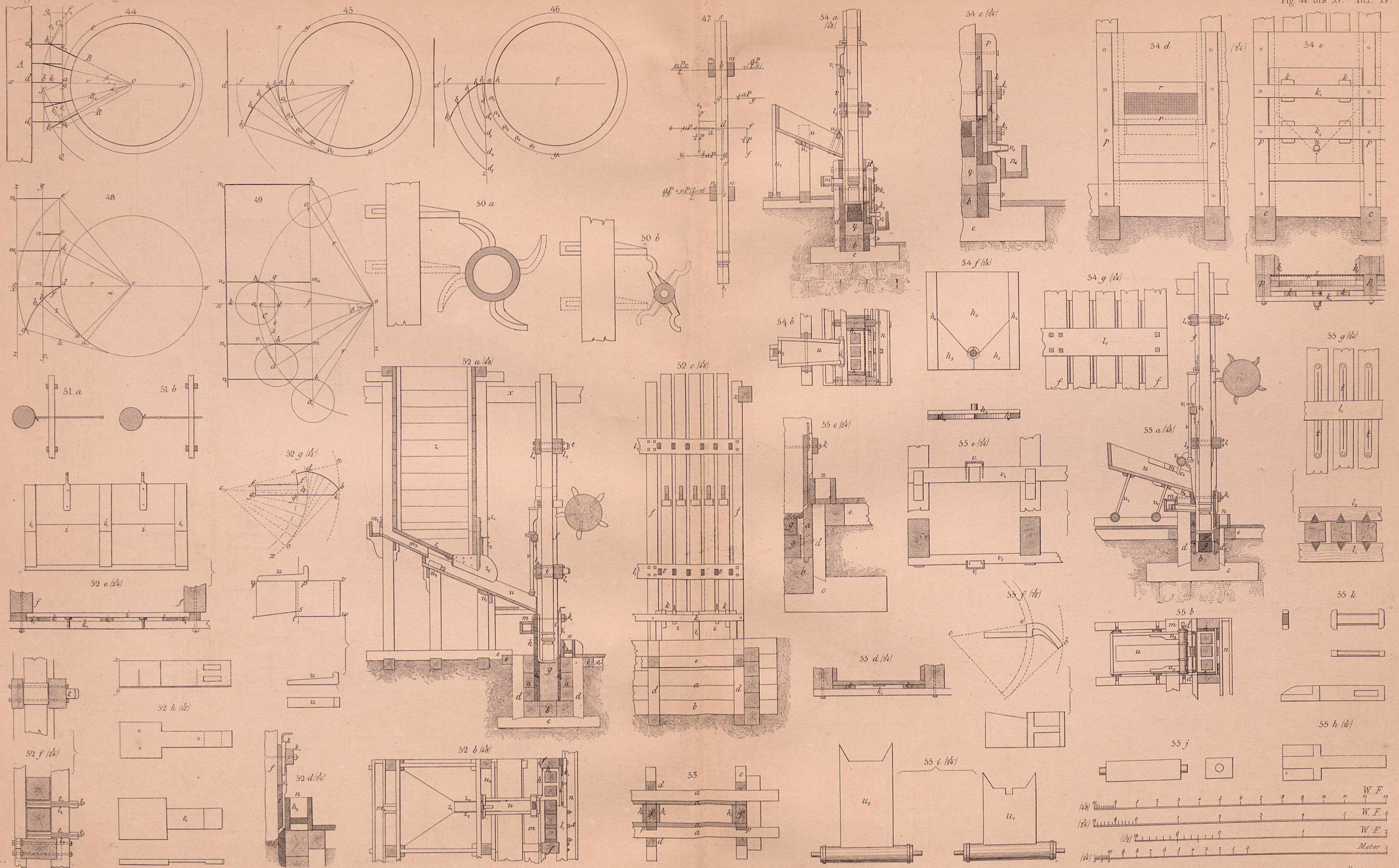

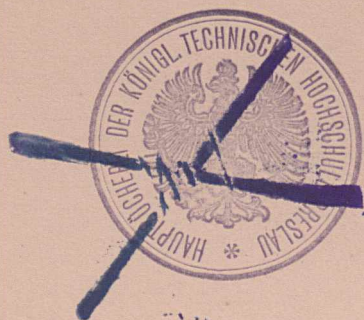

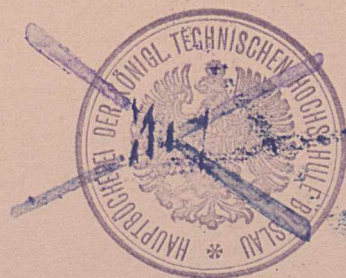

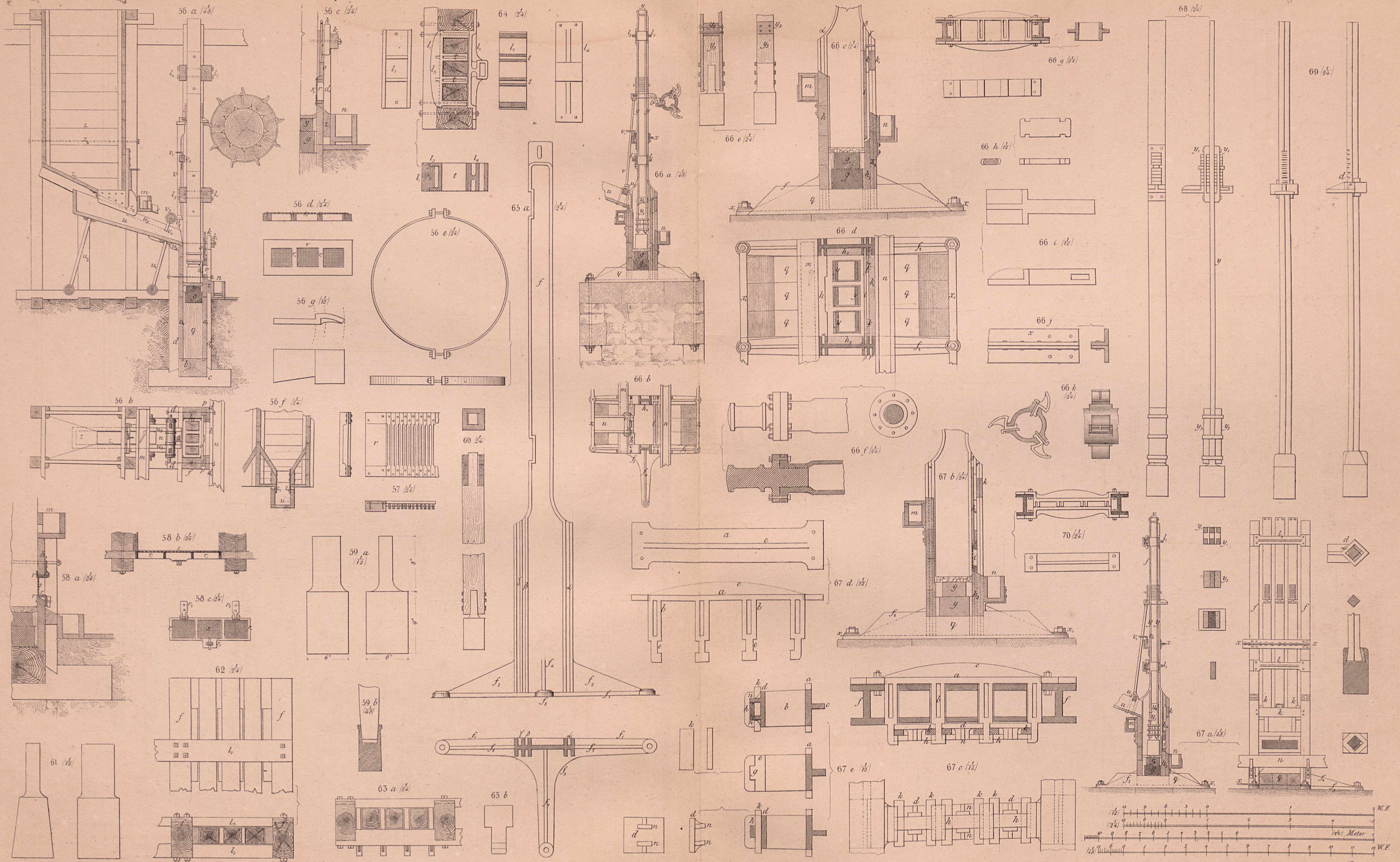

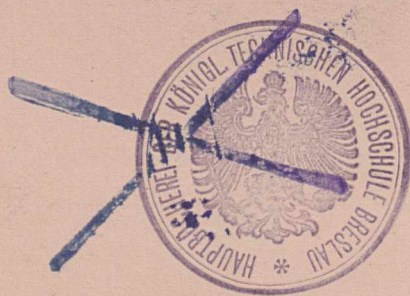



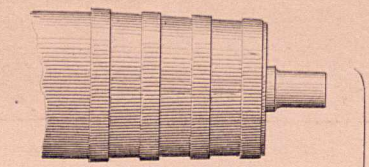
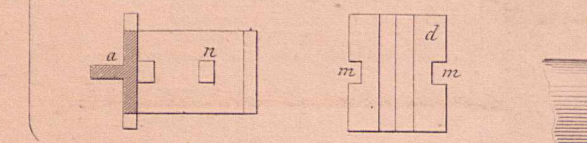
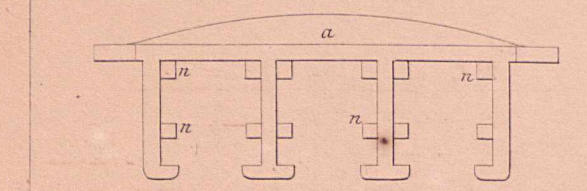
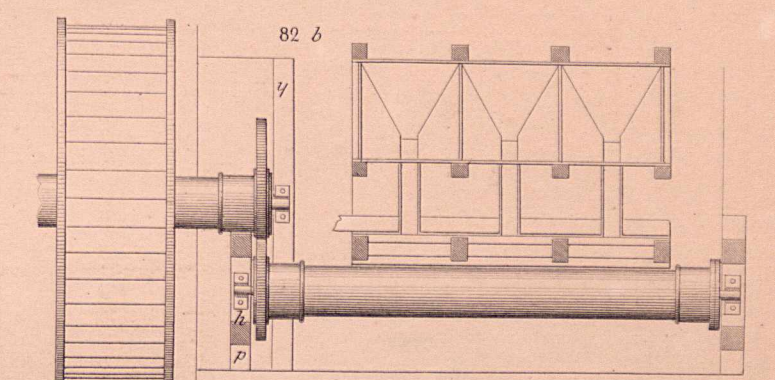
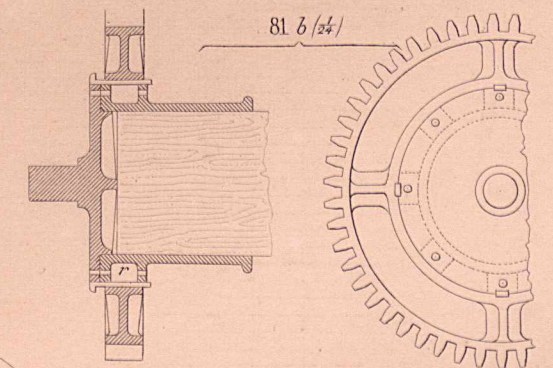
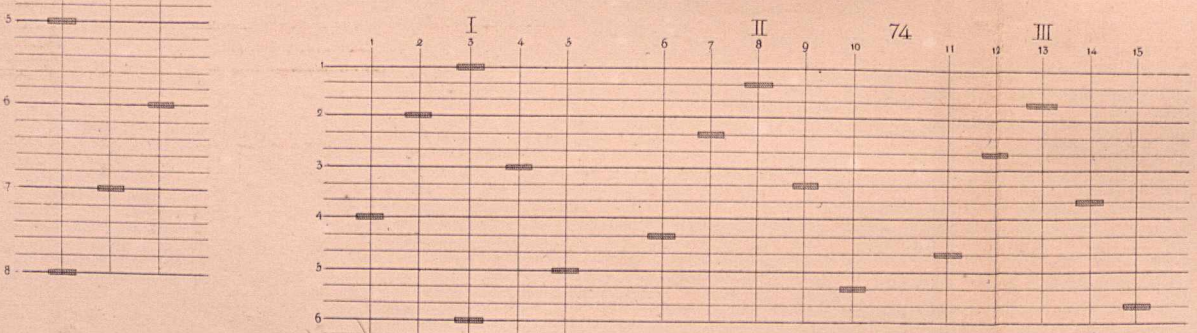
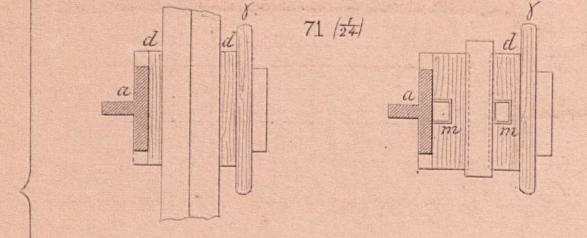
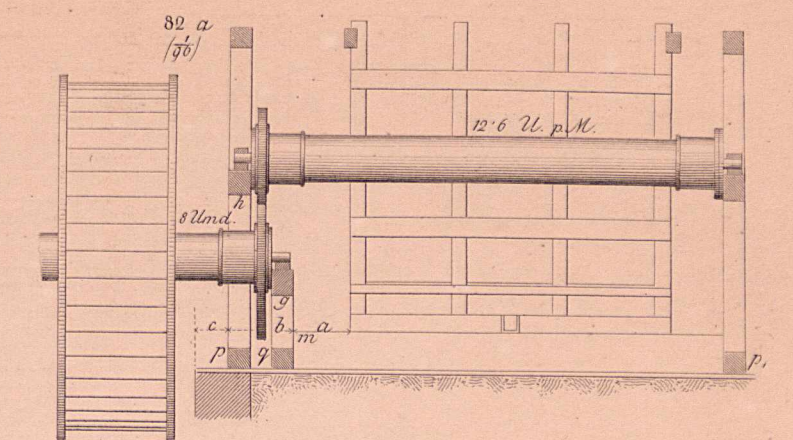
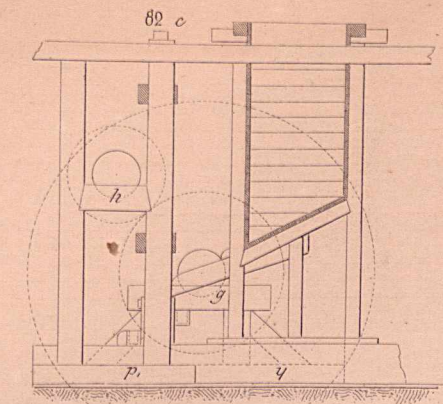
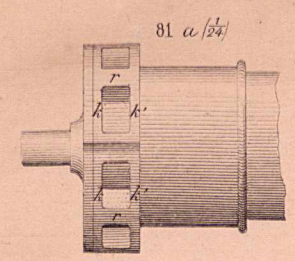
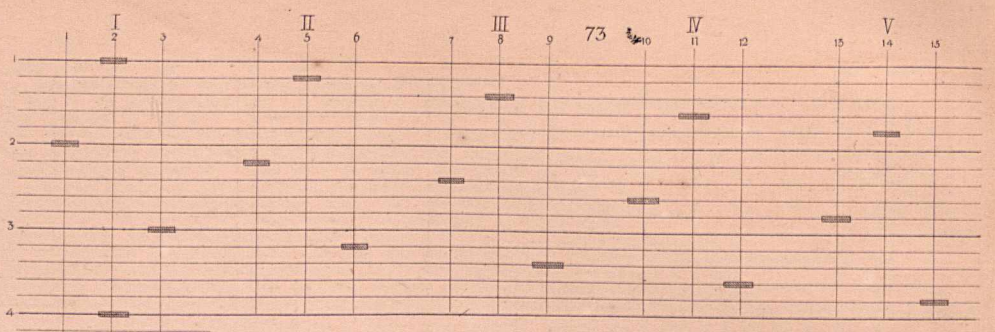
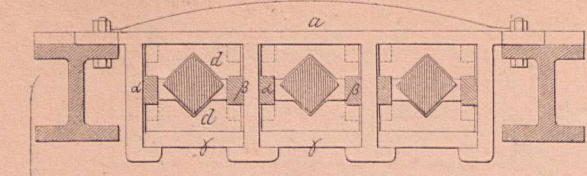

75 (1/24)

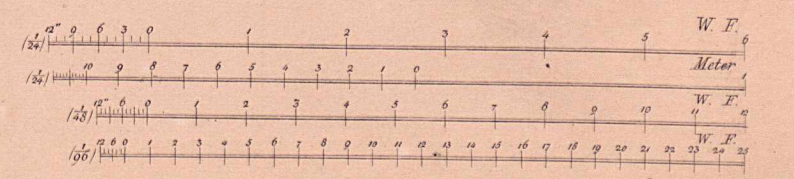
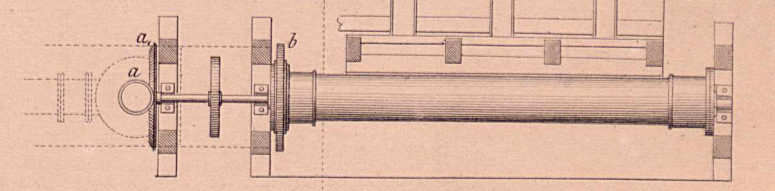
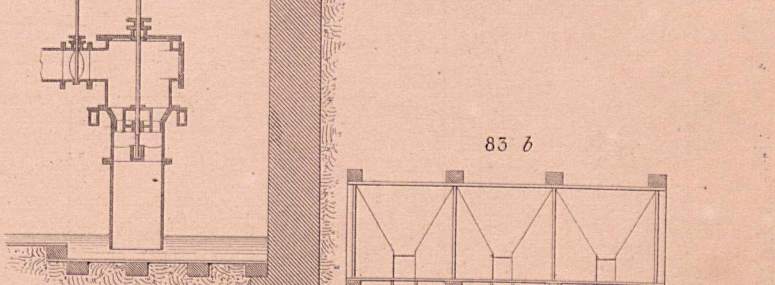
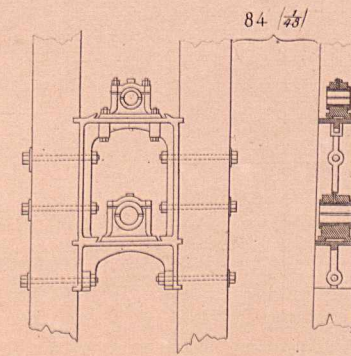
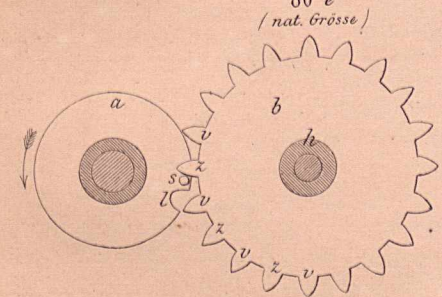
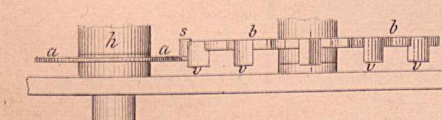
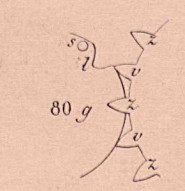
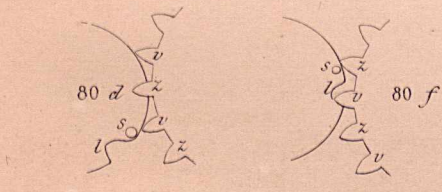
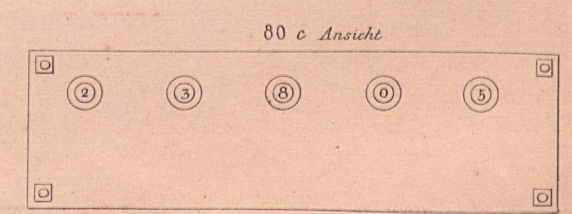
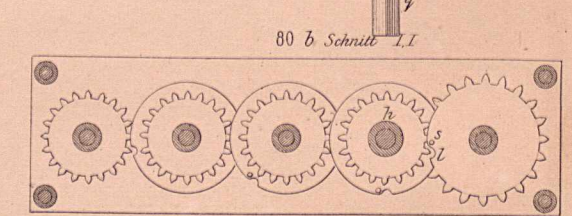
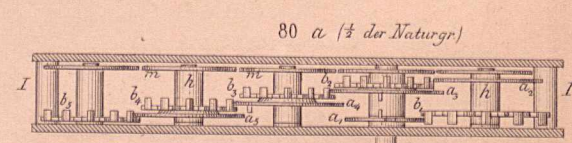
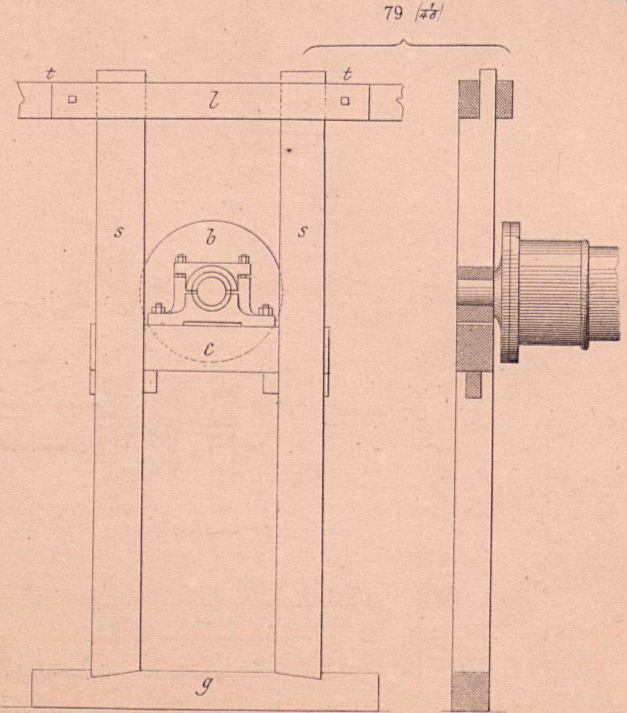
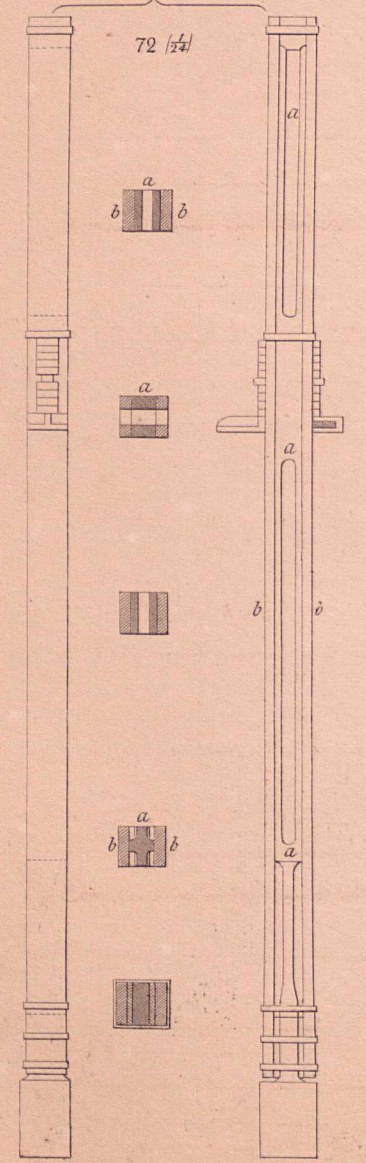
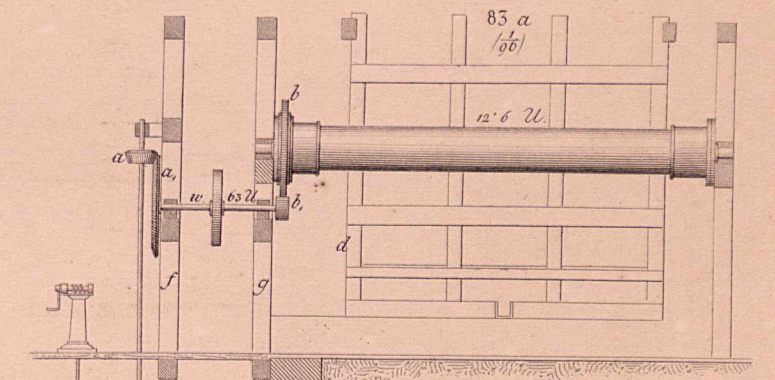
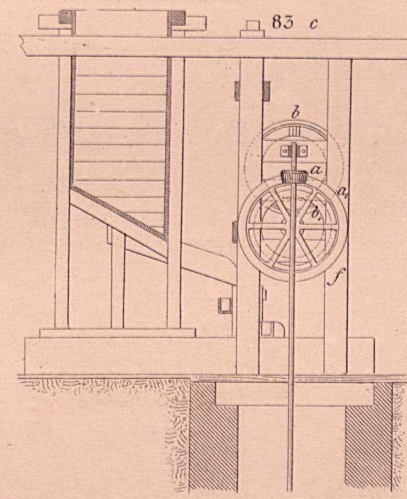
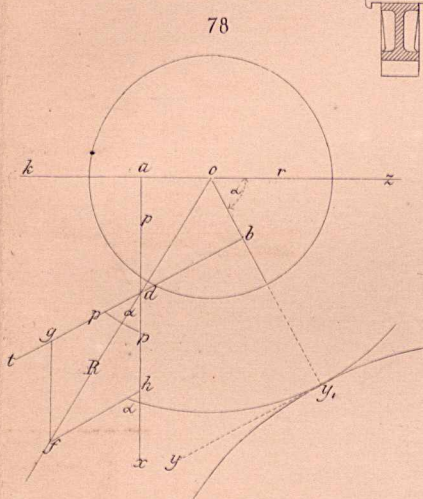
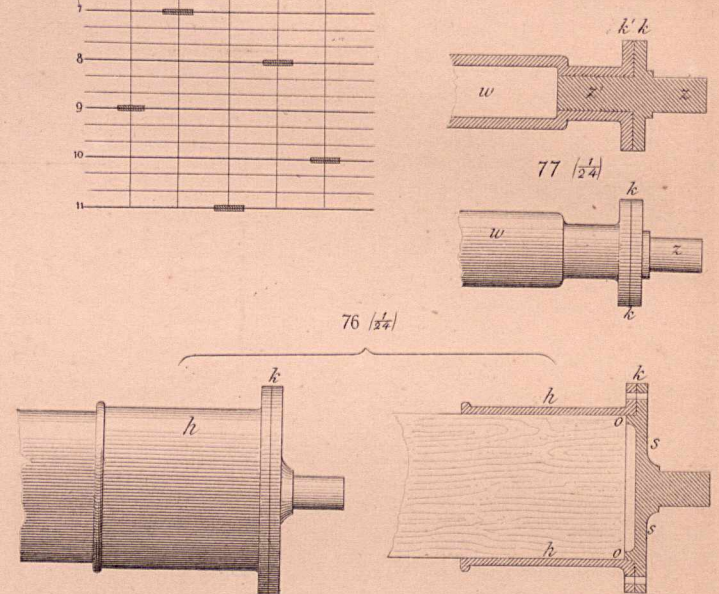
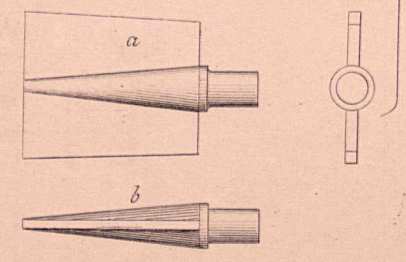

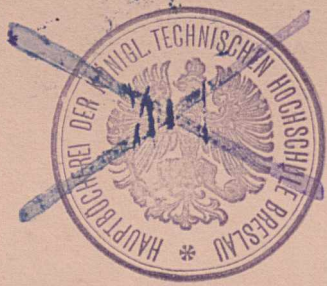
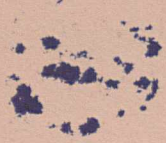

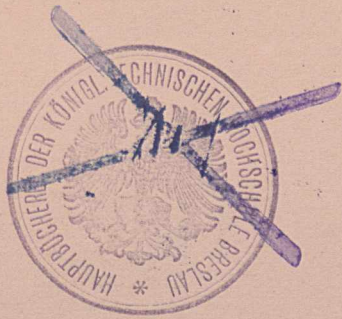

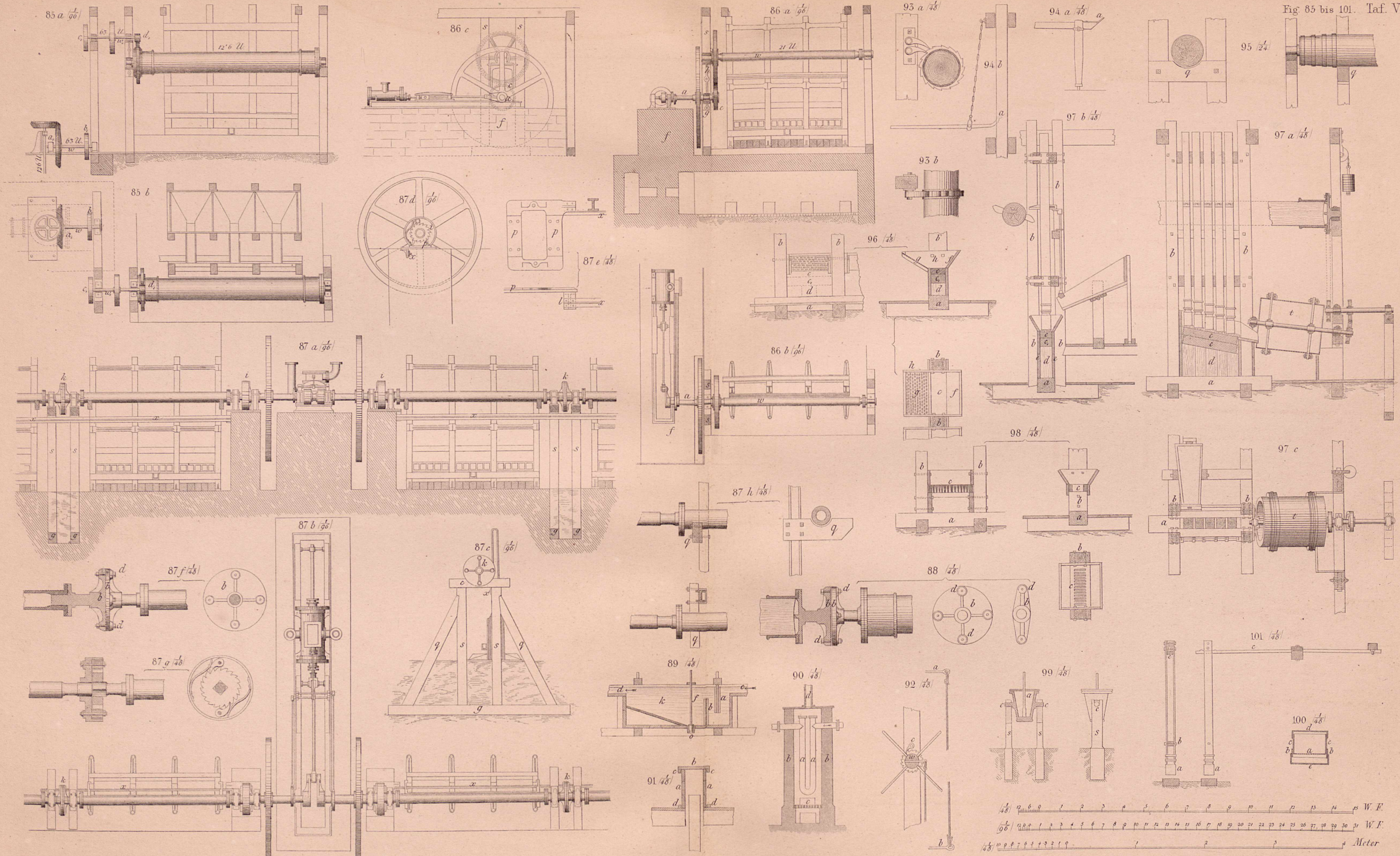

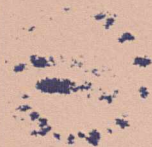

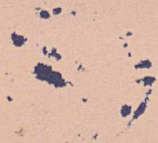
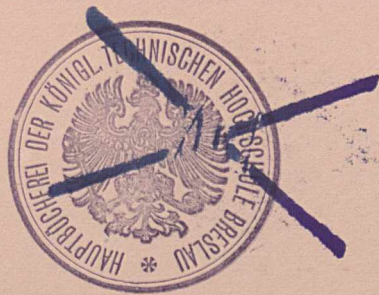

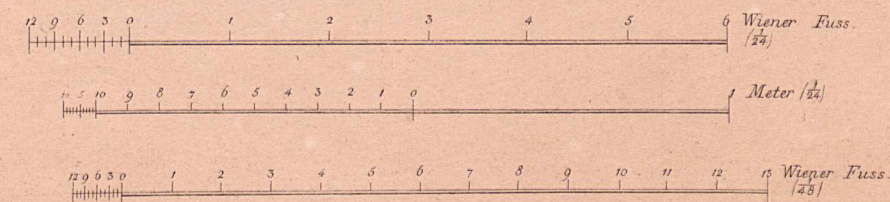
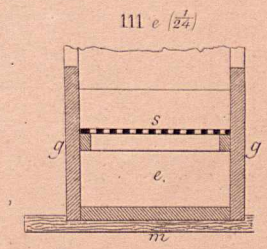
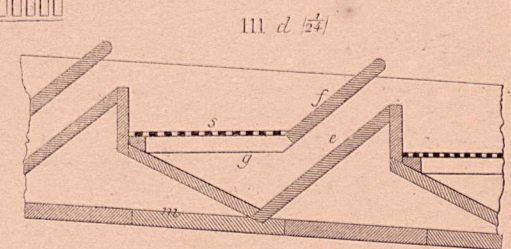
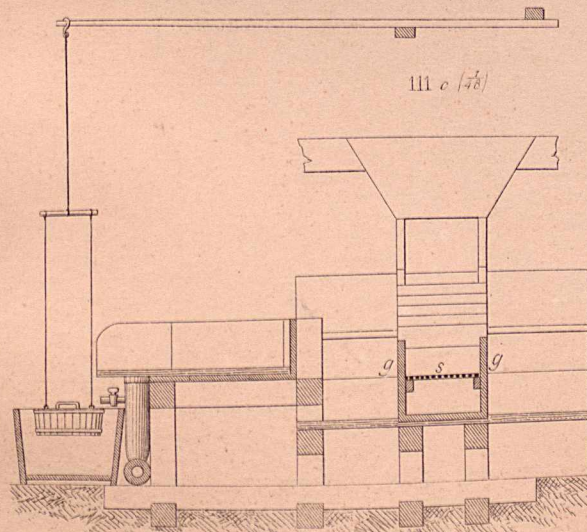
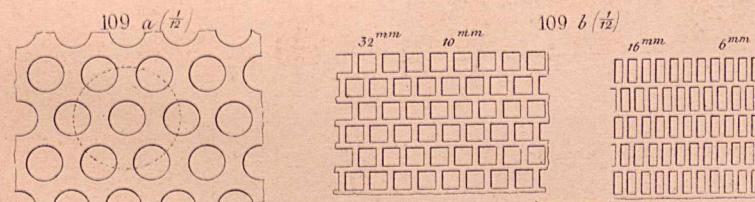
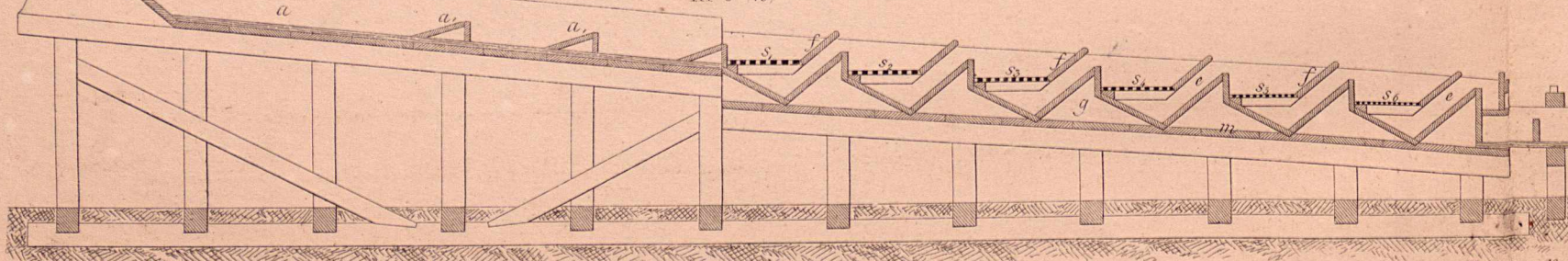
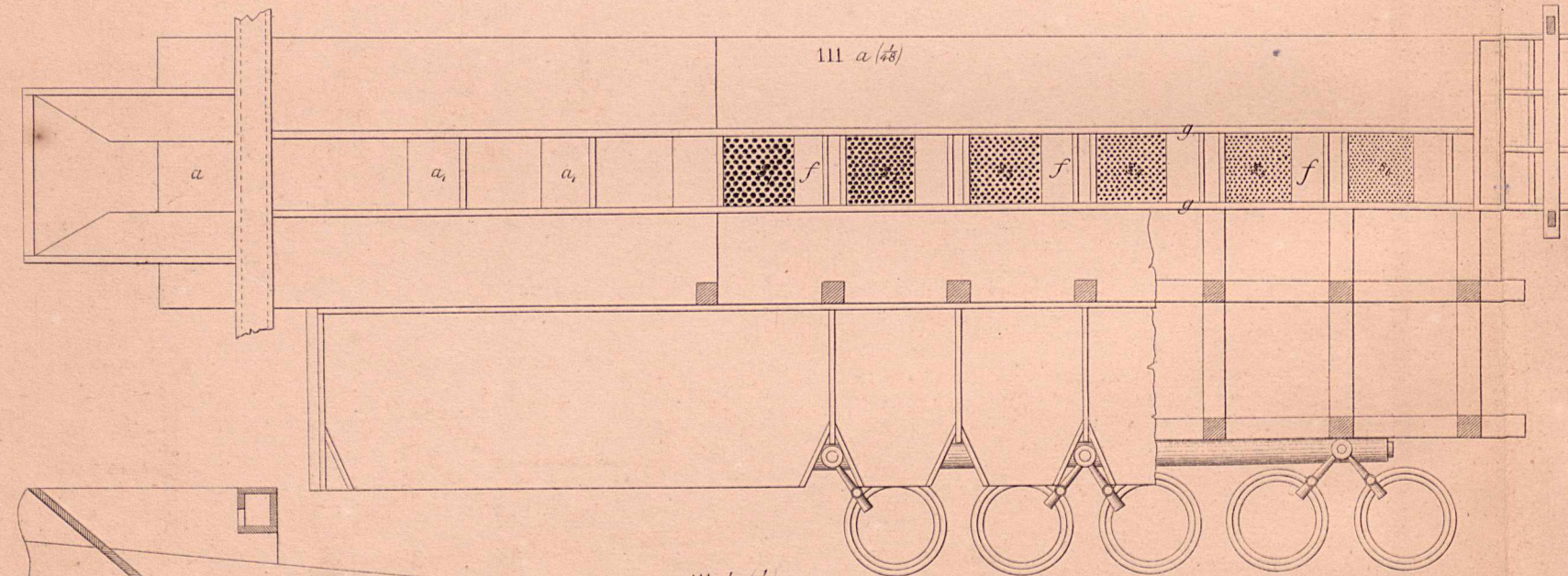
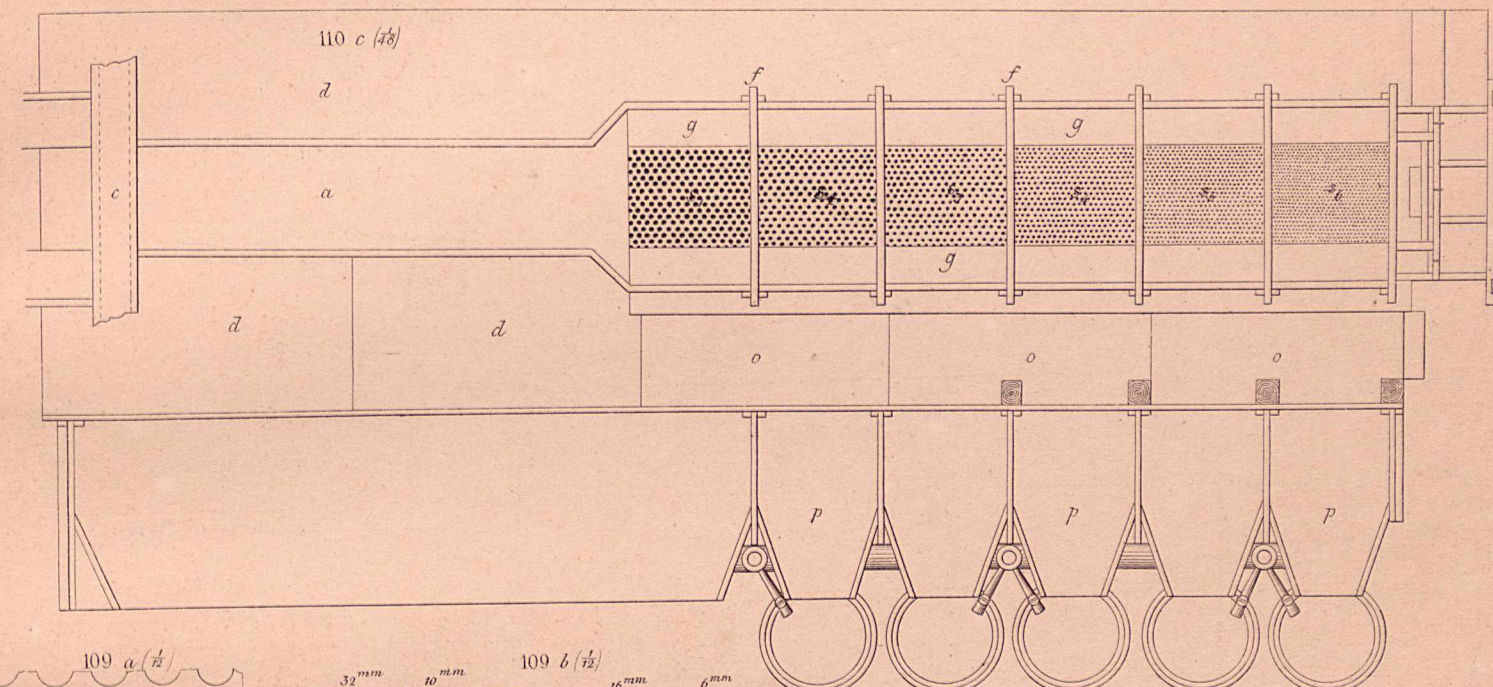
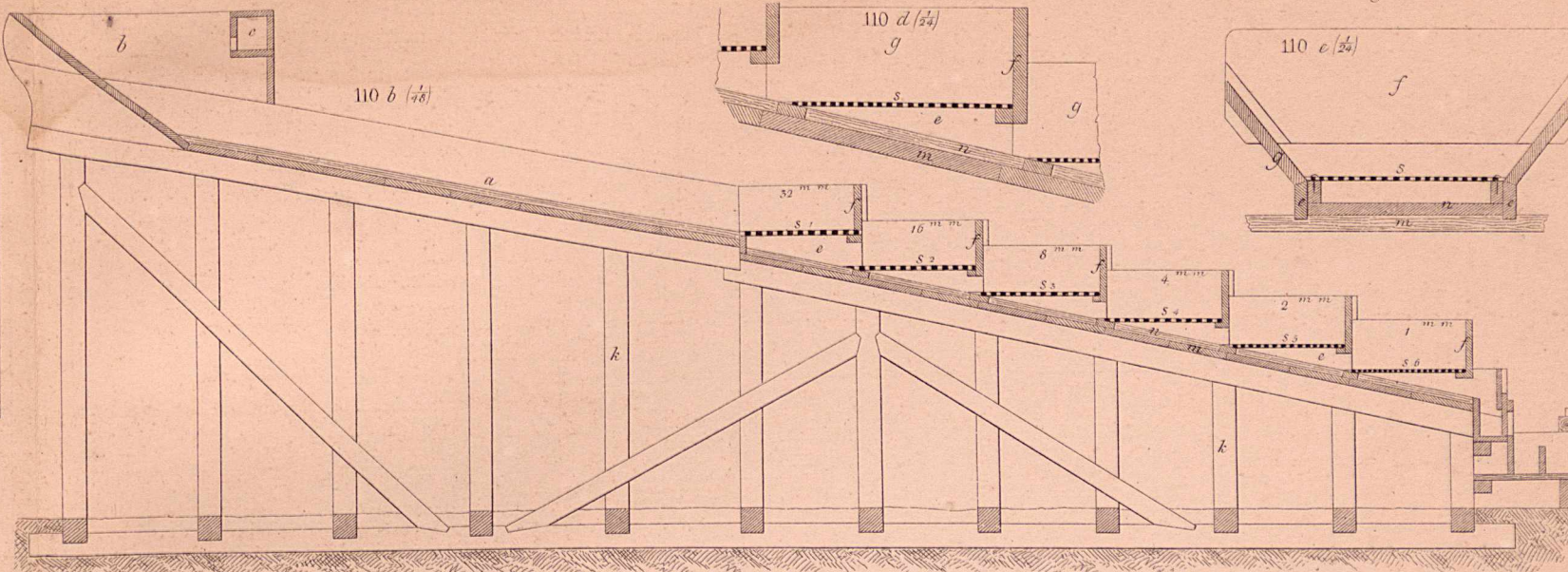
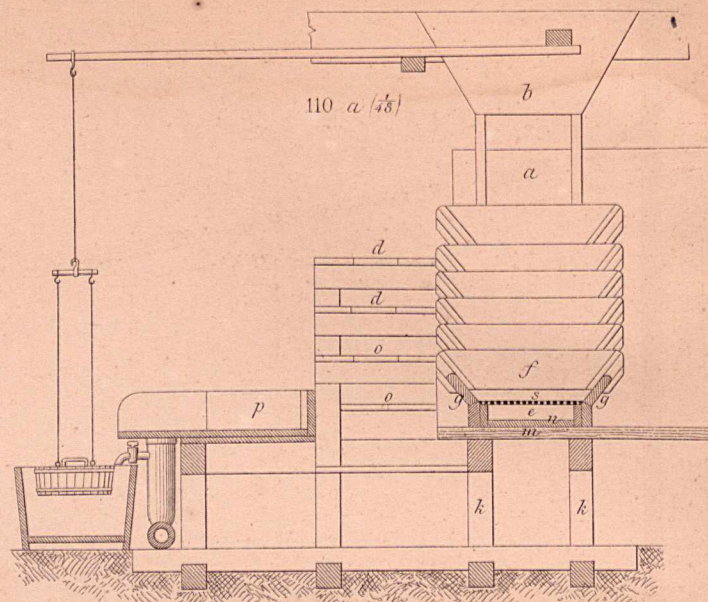
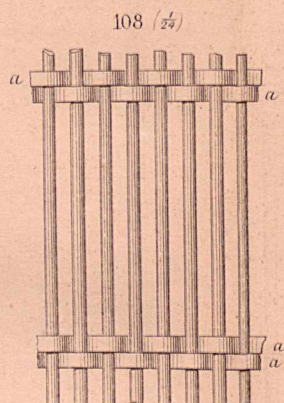
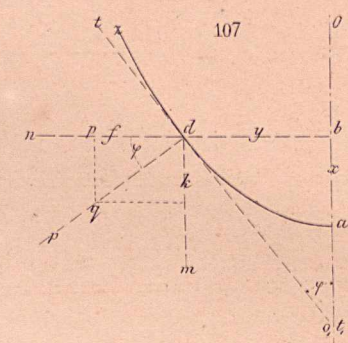
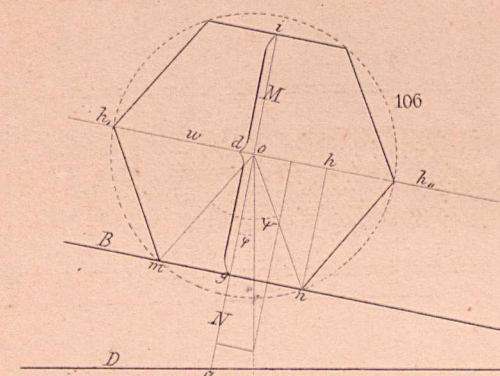
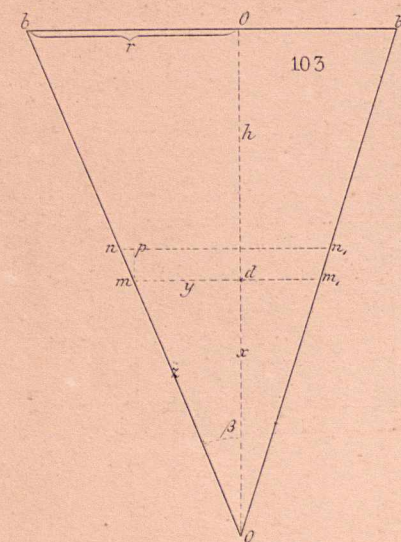
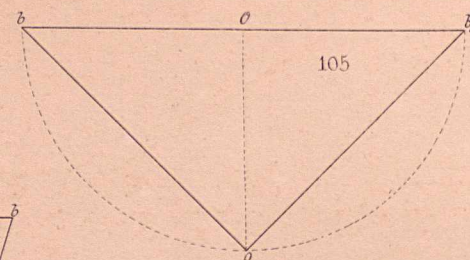
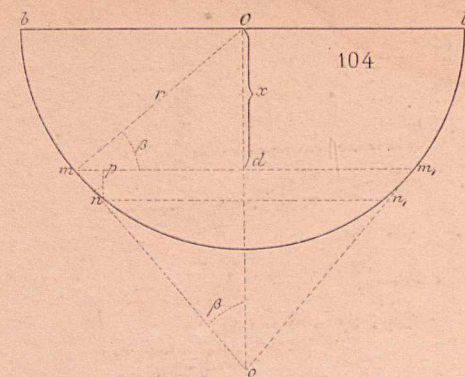
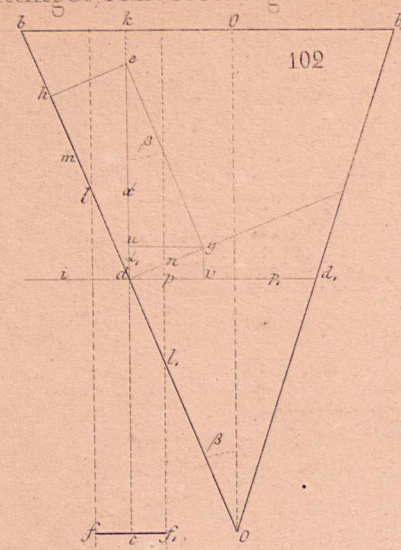

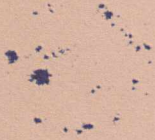
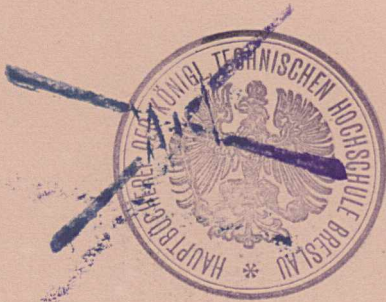

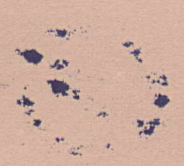

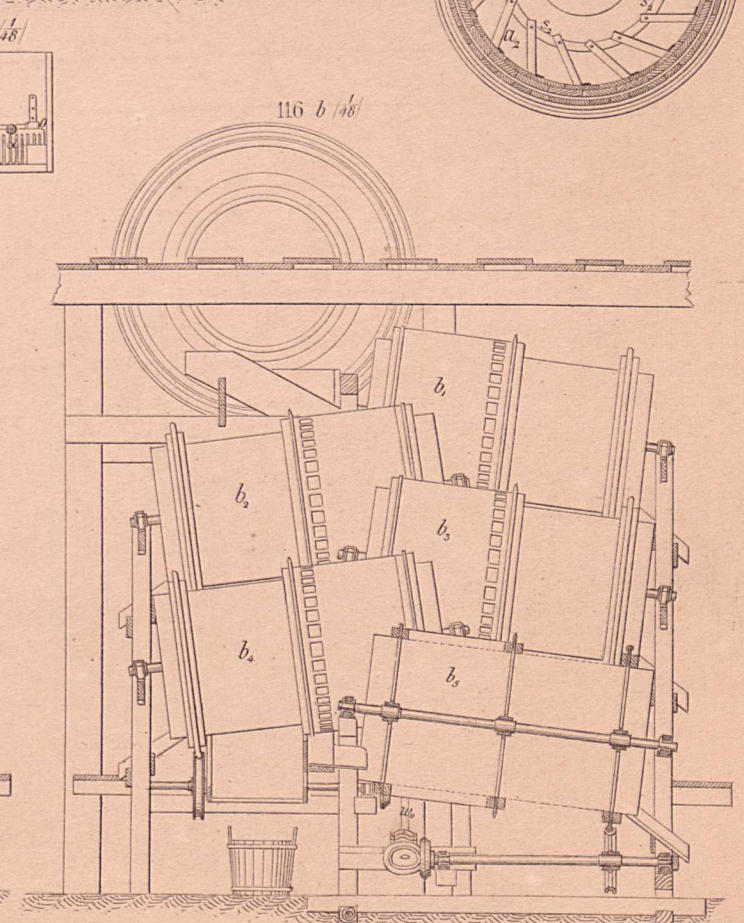
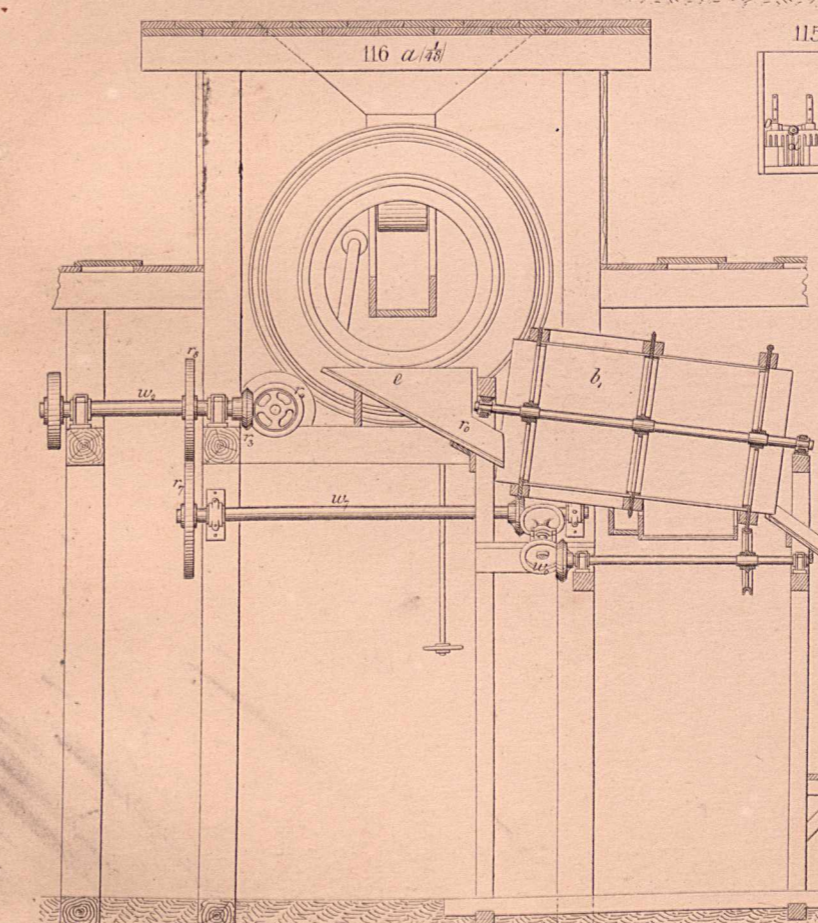
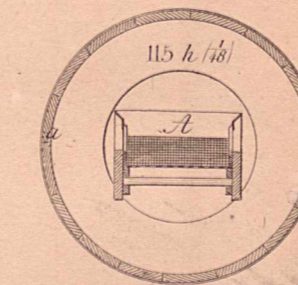
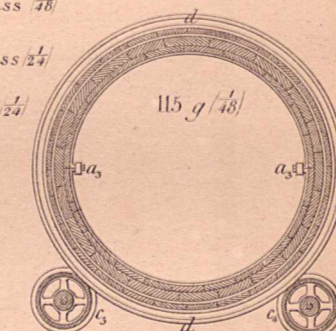
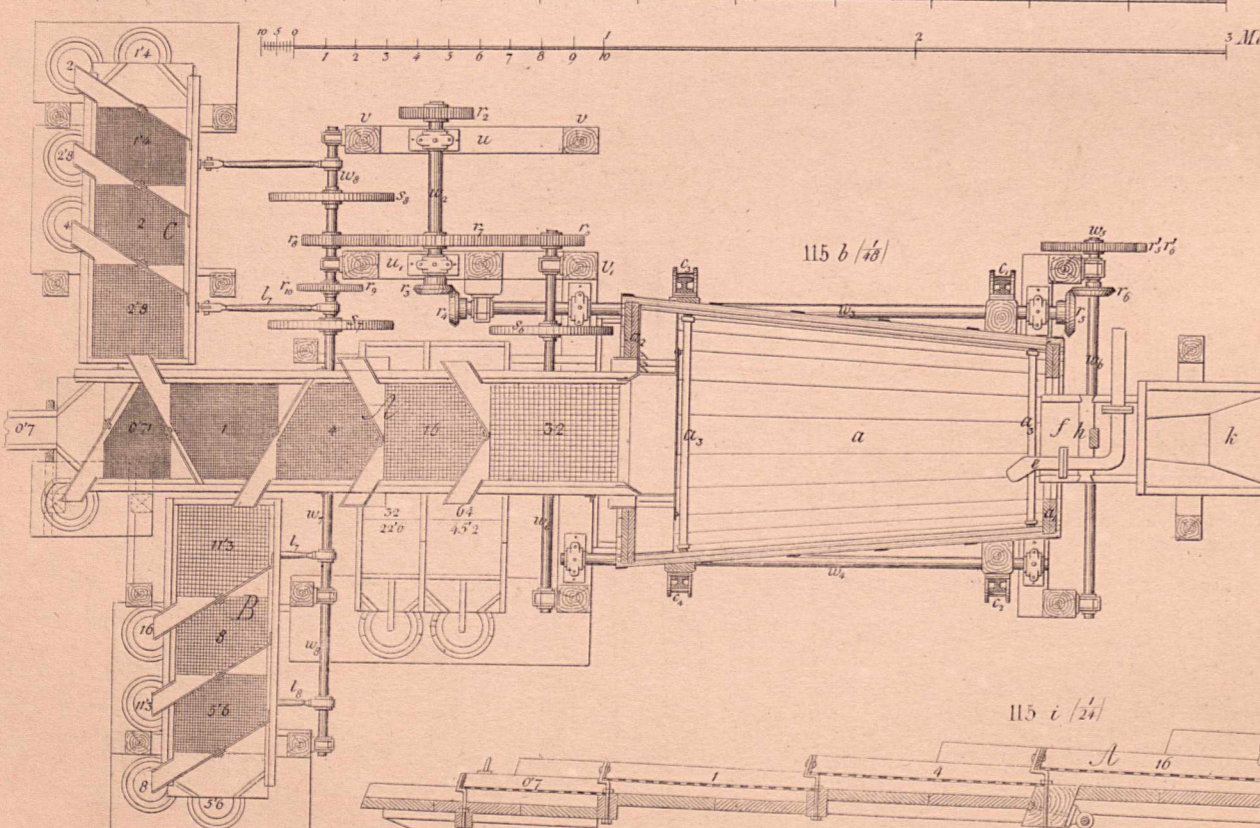
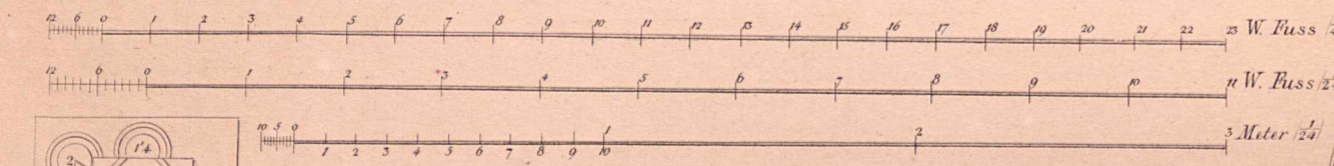
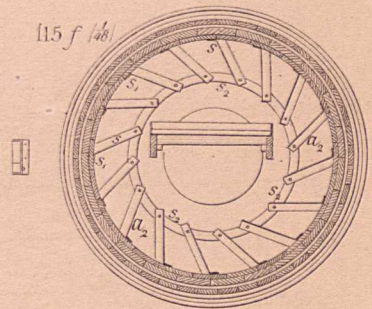
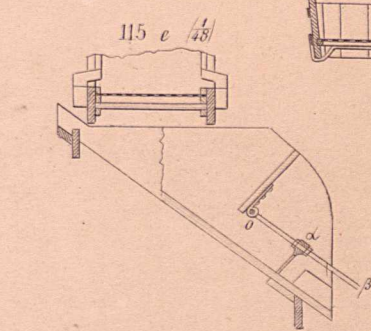
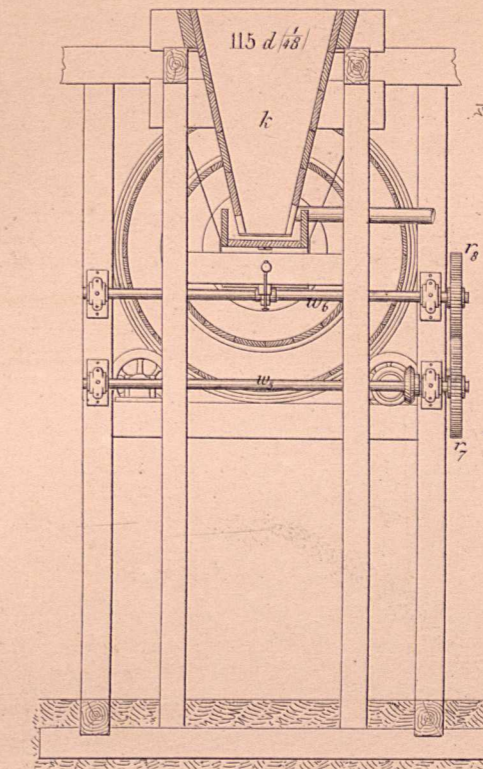
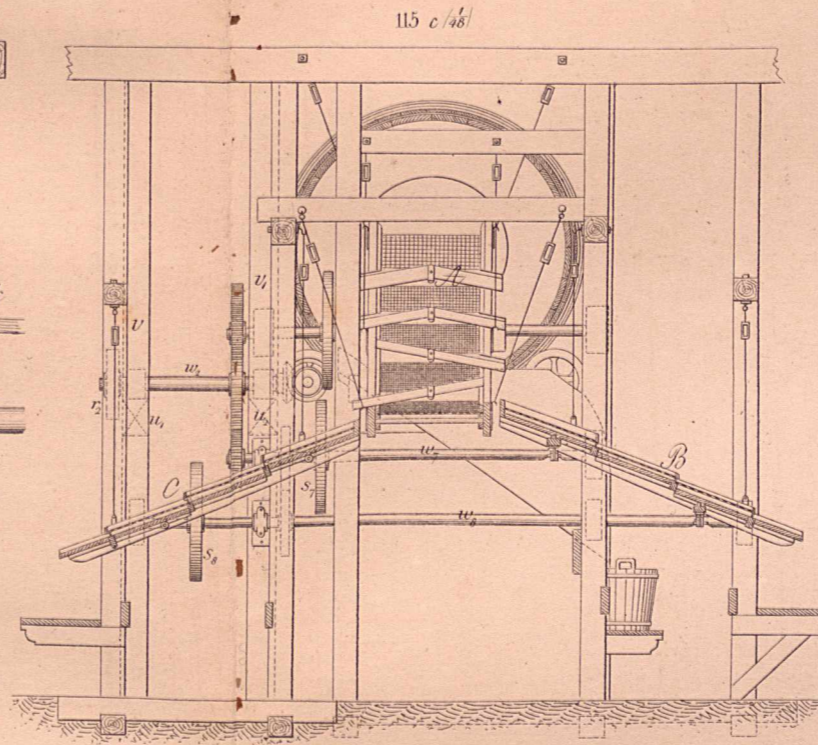
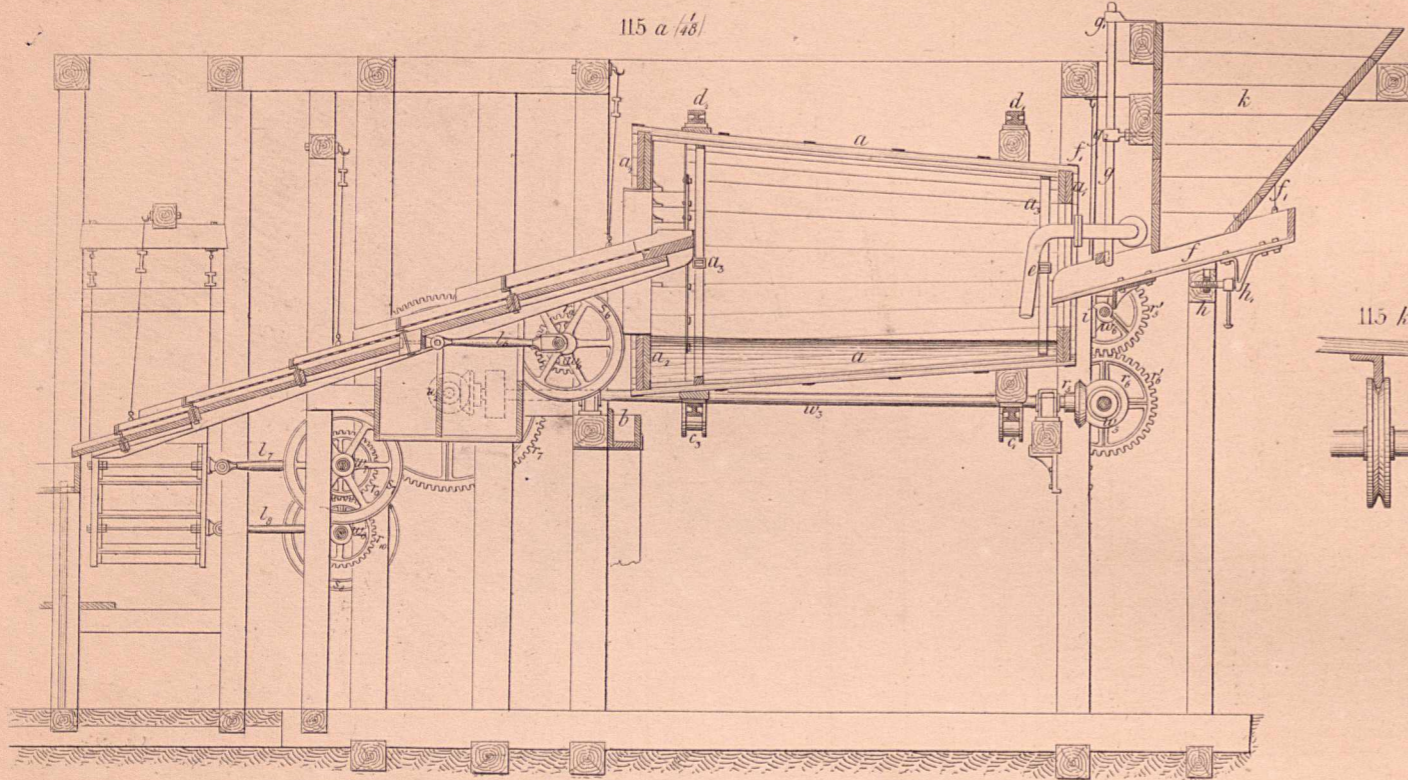
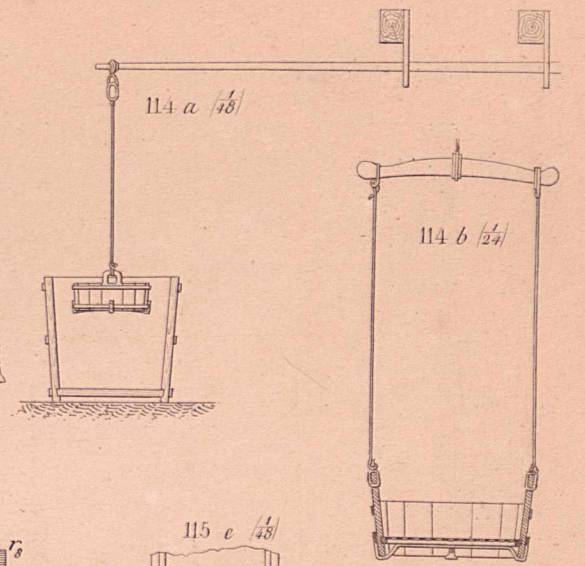
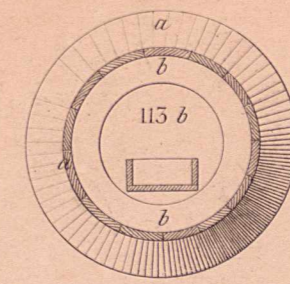
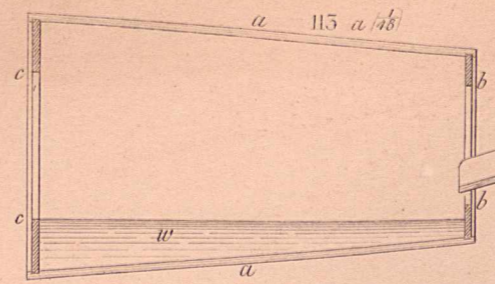
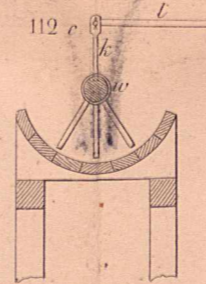
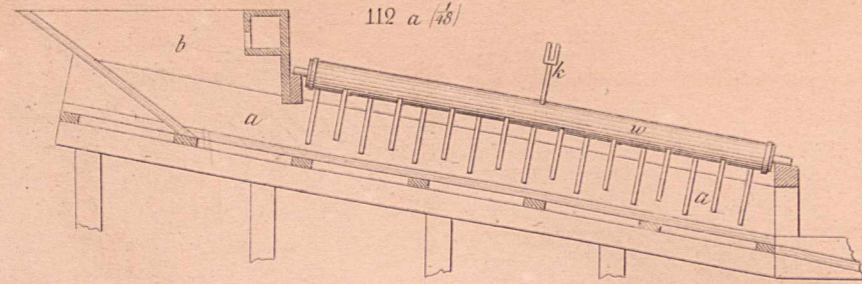
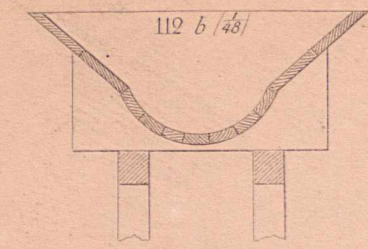

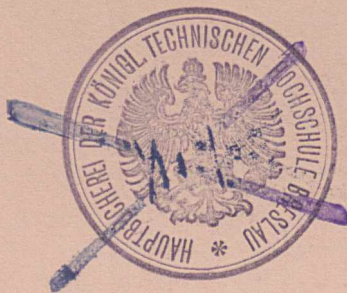

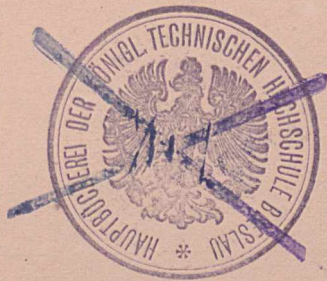

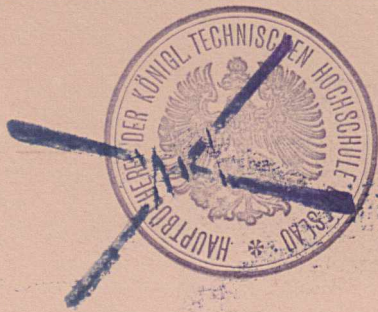

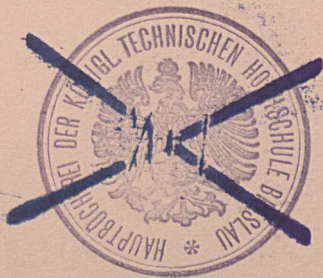

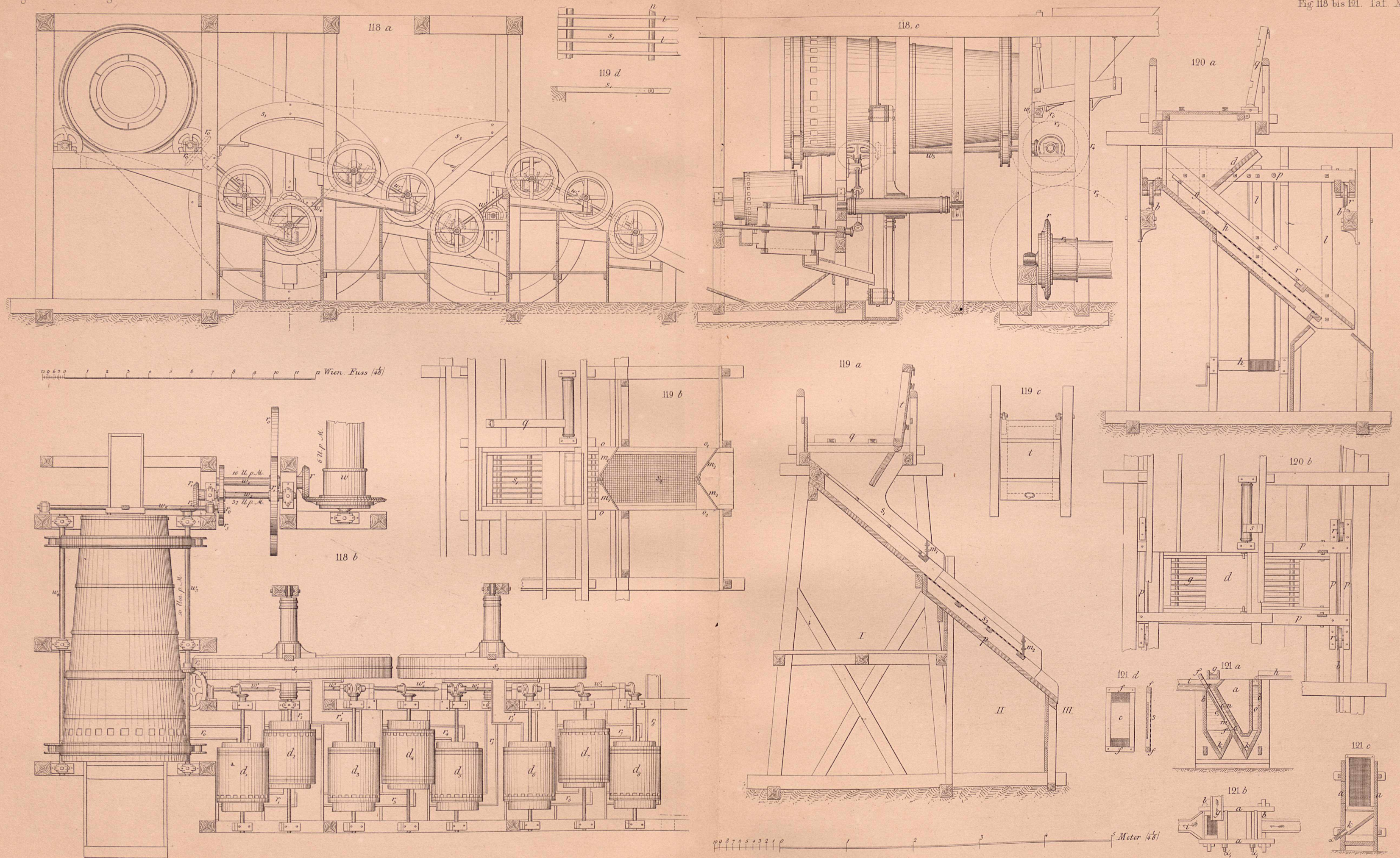

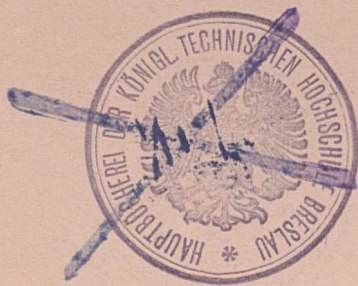

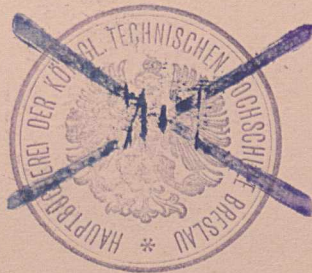

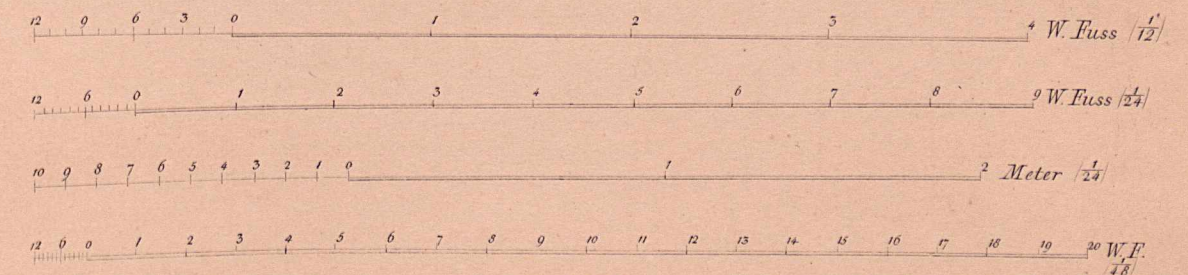
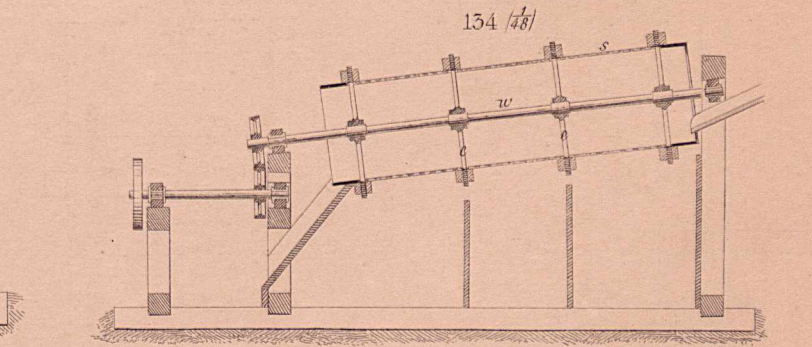
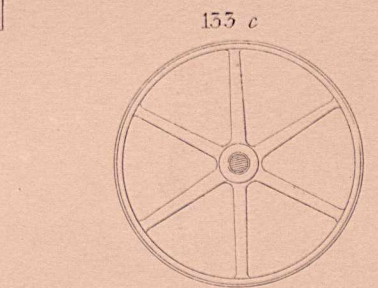
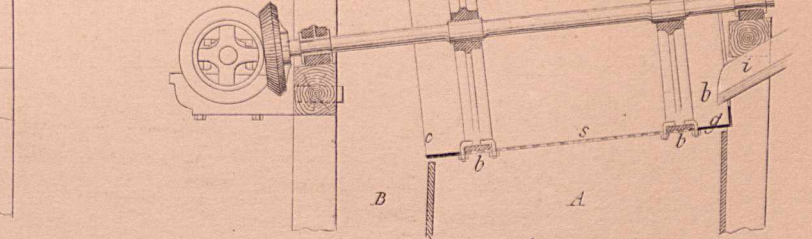
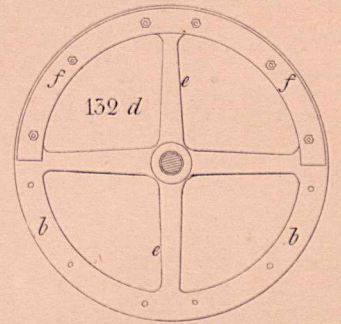
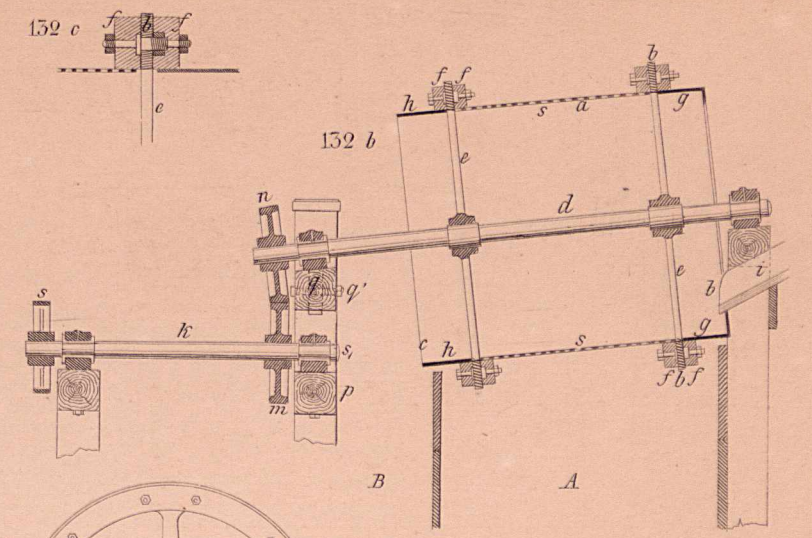
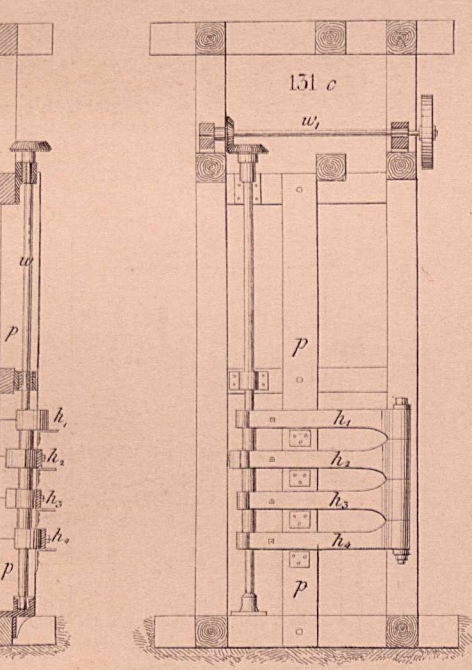
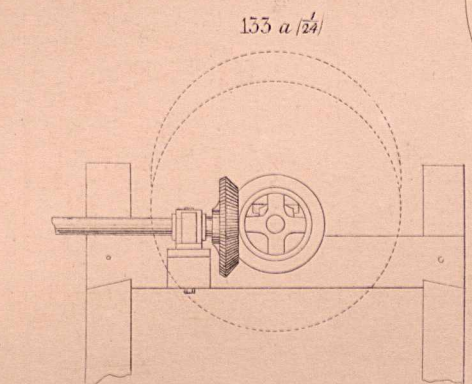
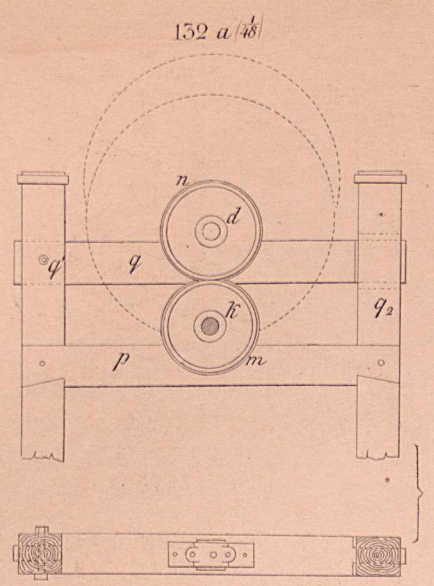
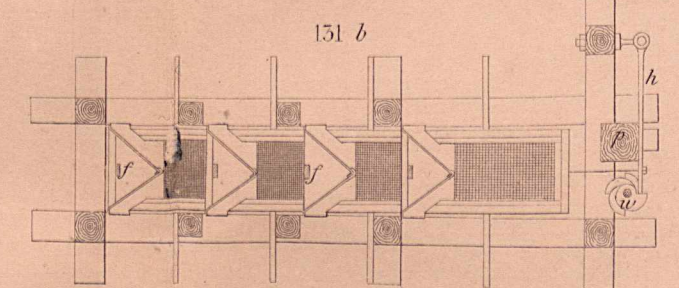
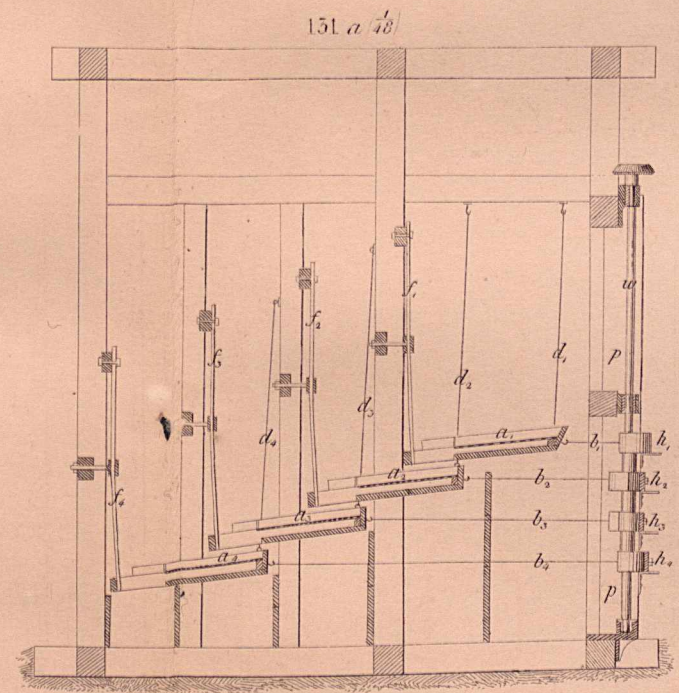
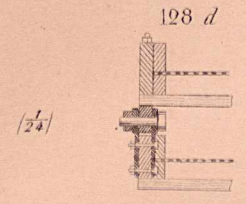
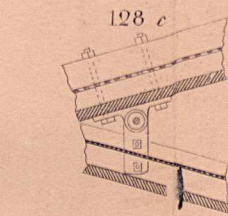
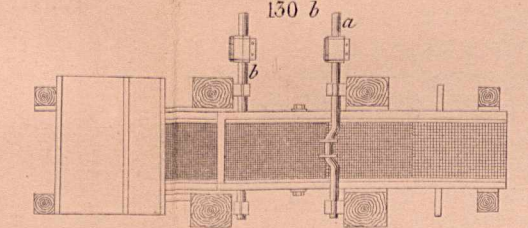
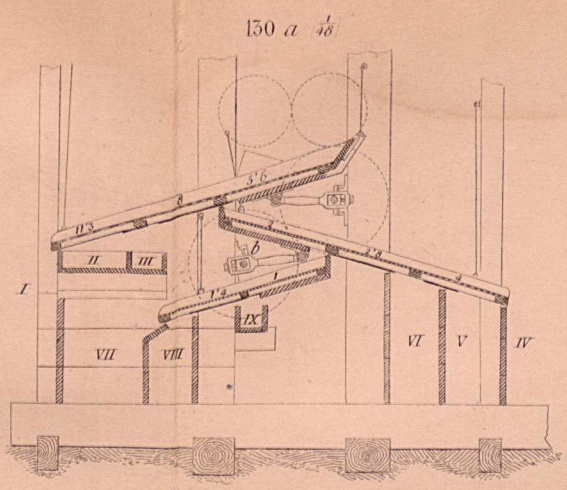
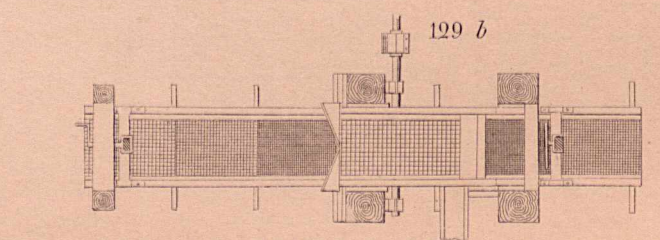
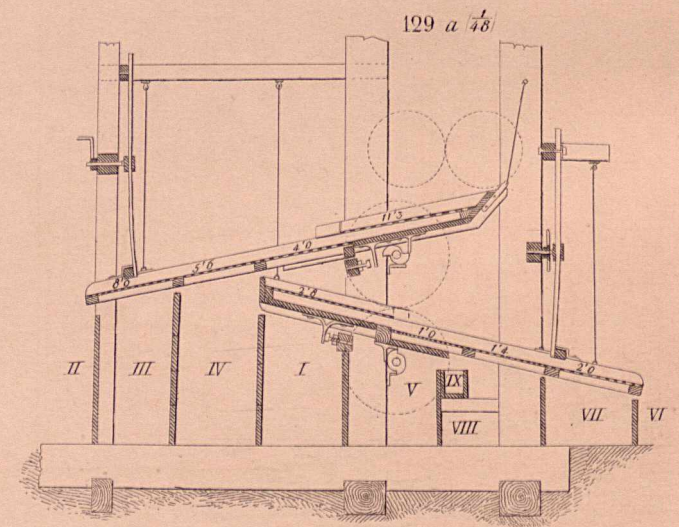
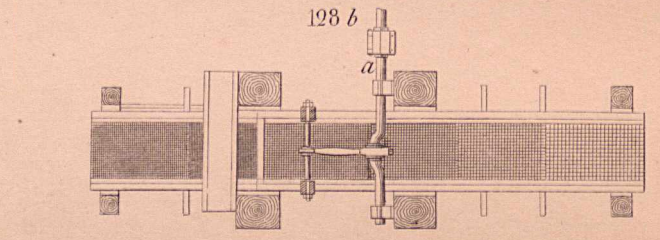
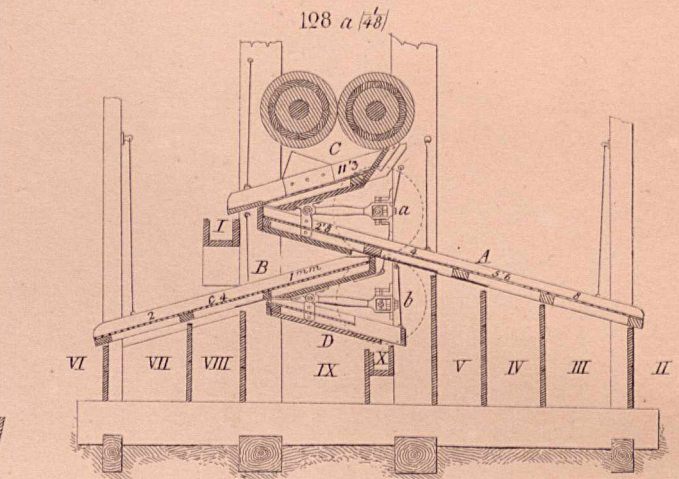
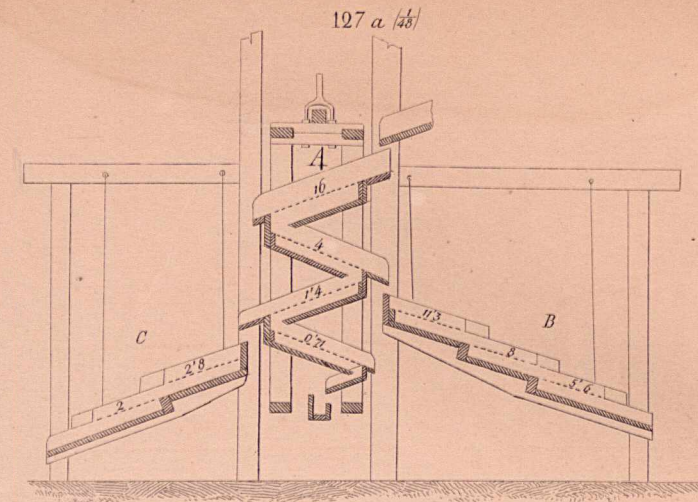
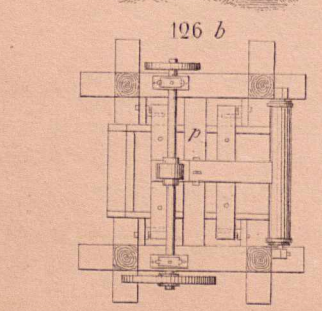
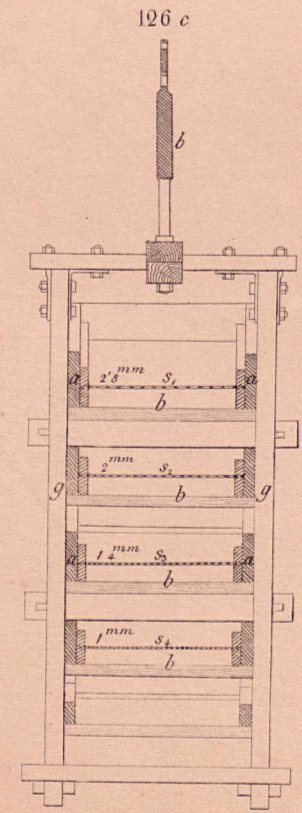
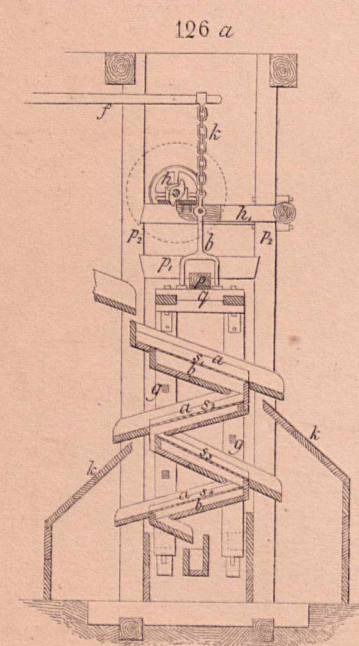
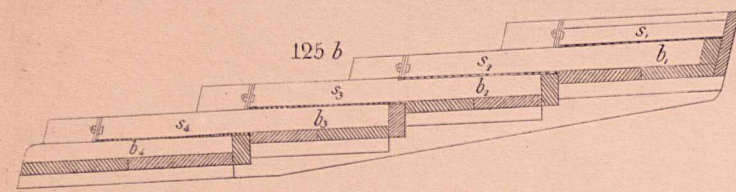
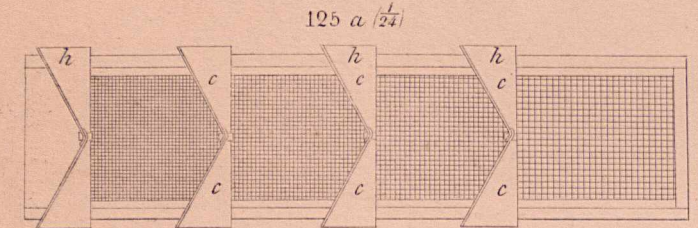
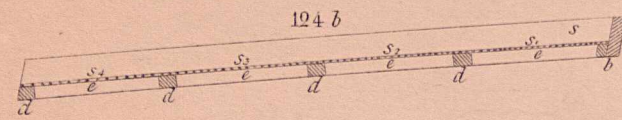
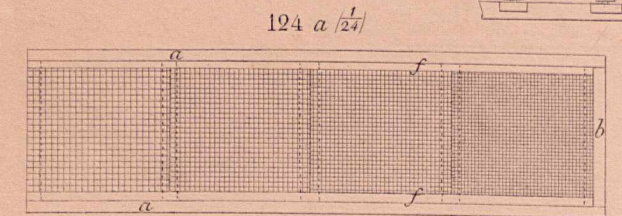
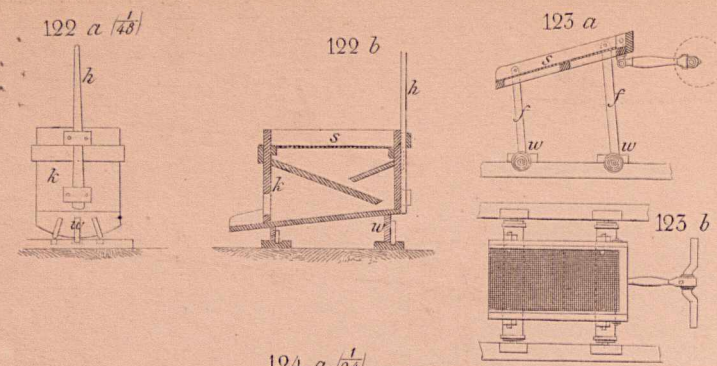

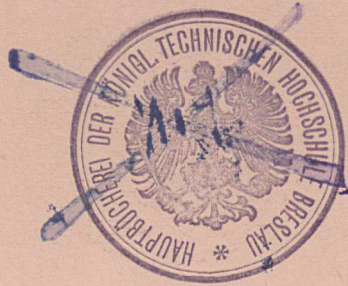

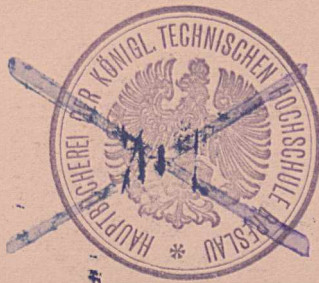

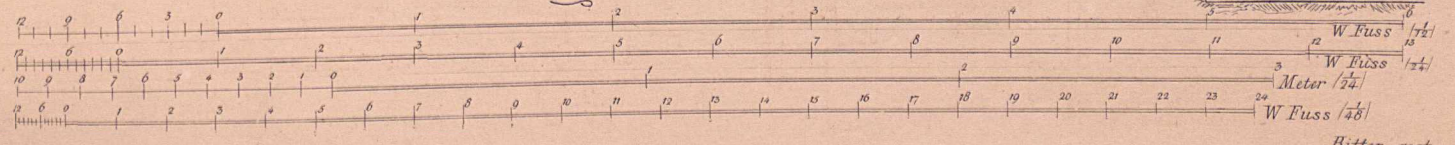
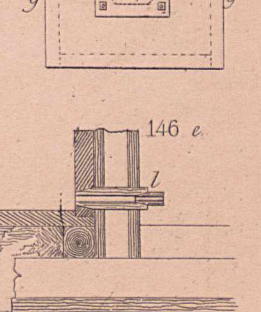
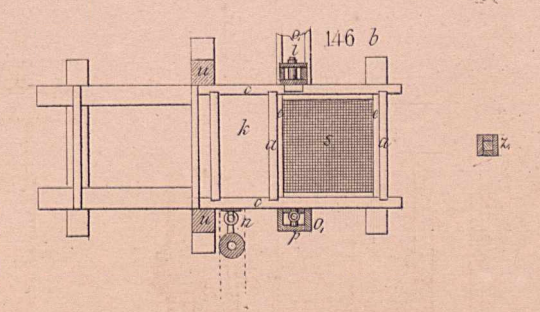
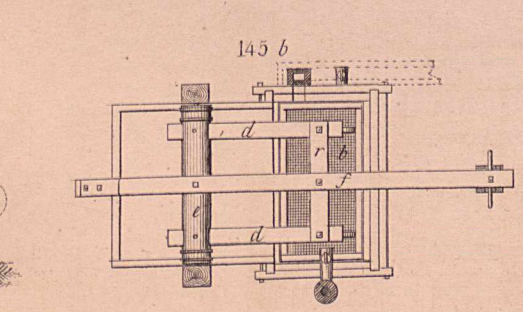
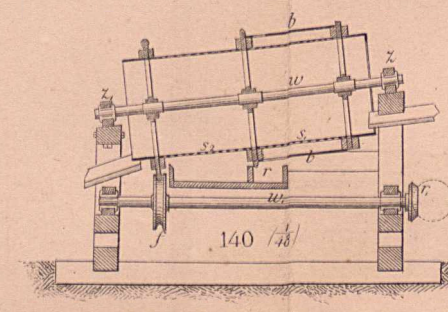
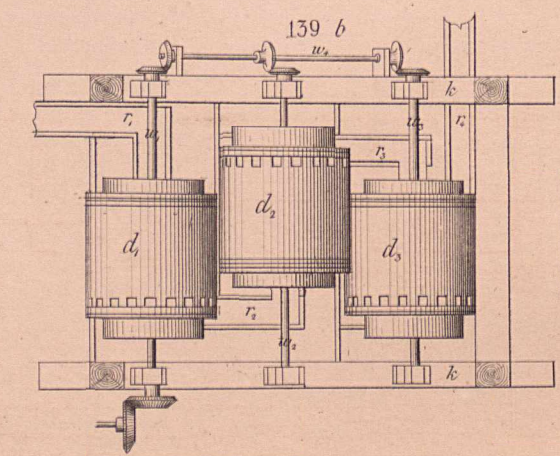
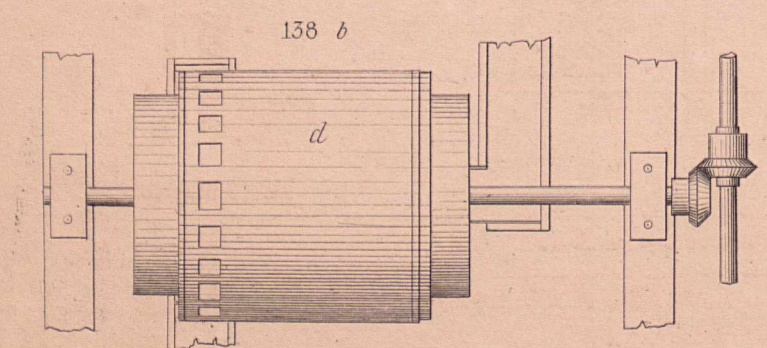
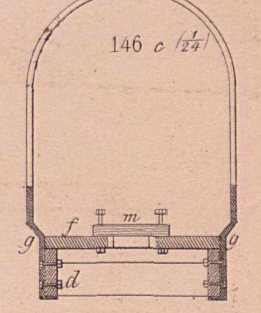
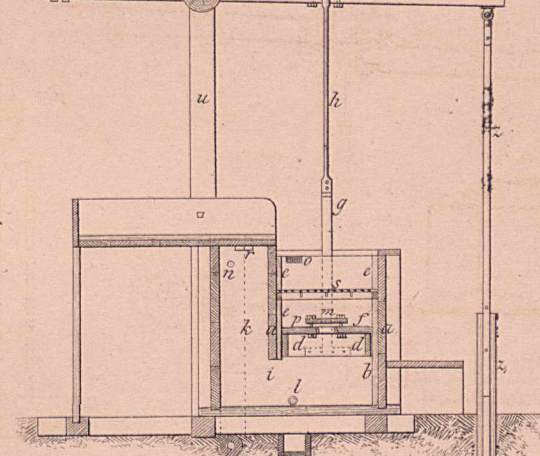
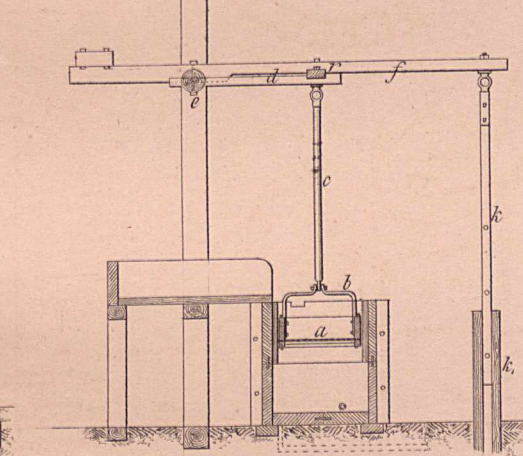
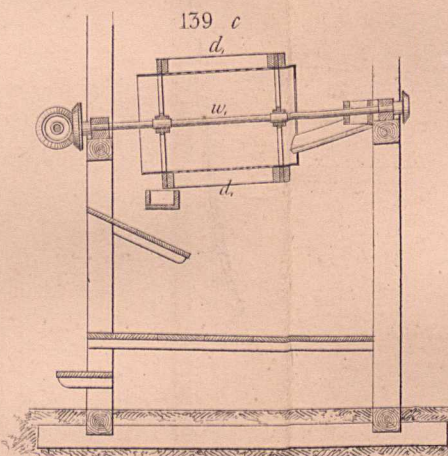
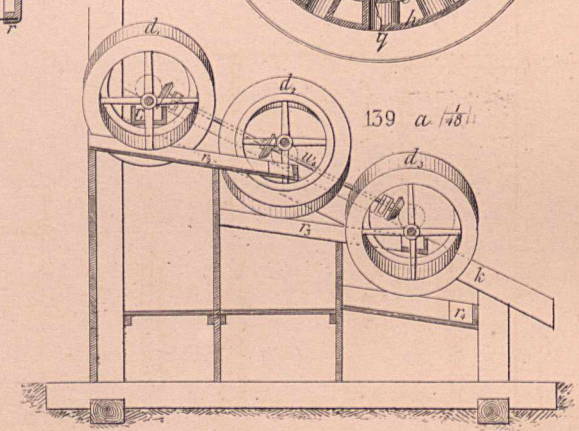
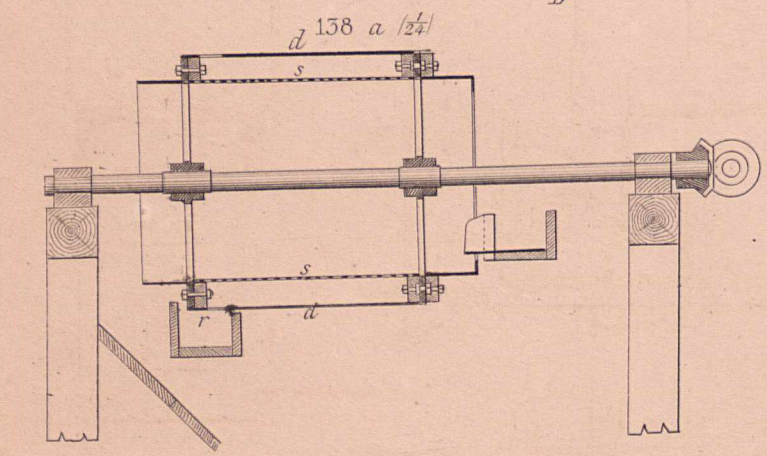
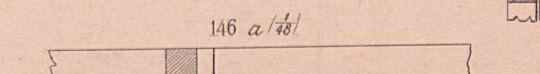
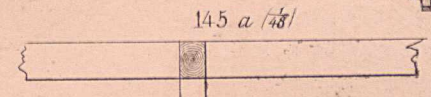
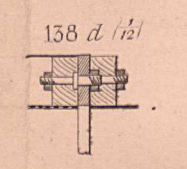
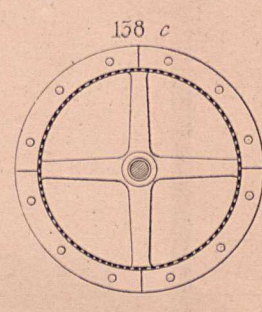
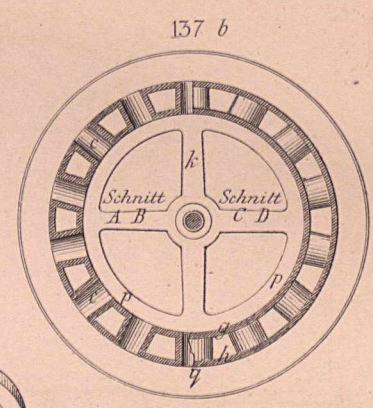
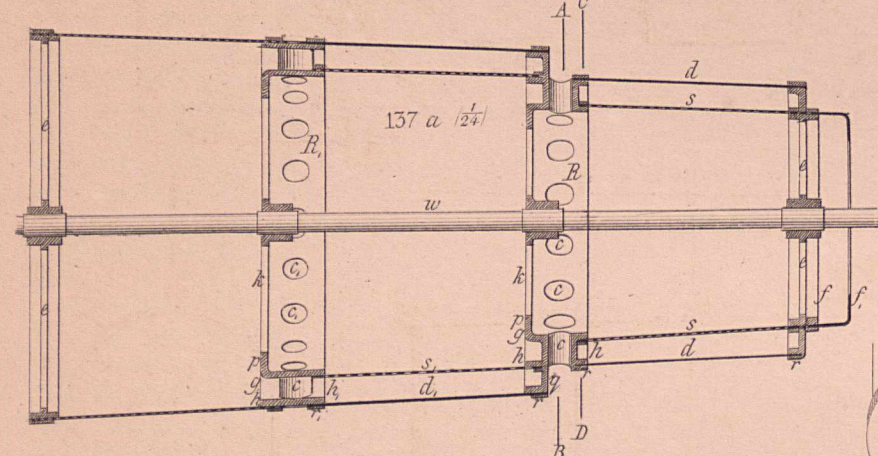
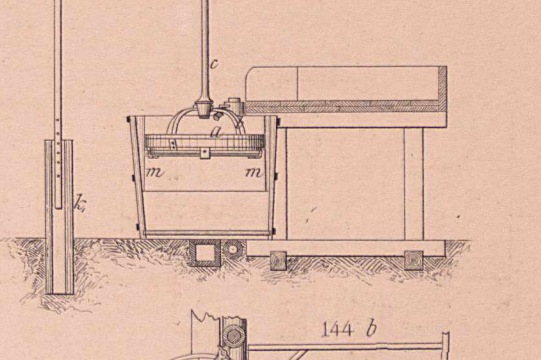
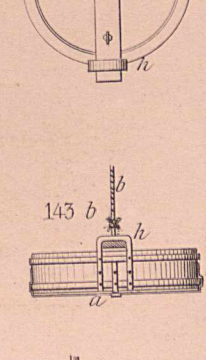
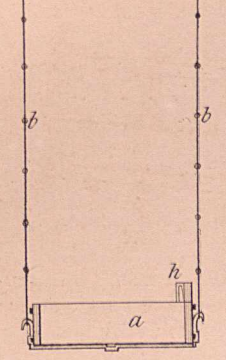
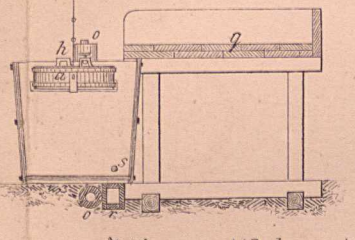
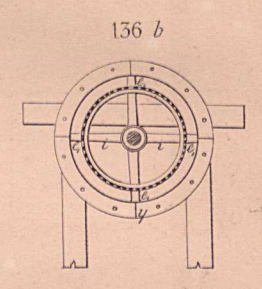
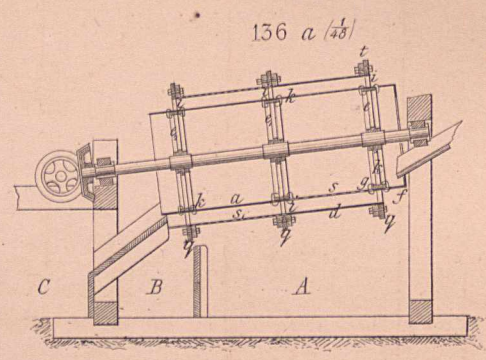
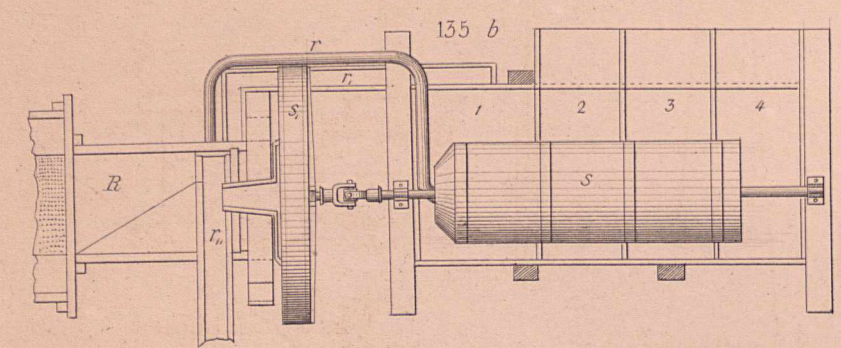
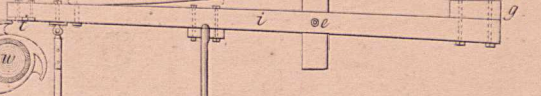
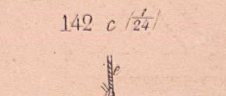
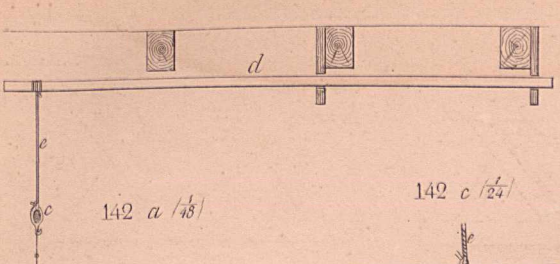
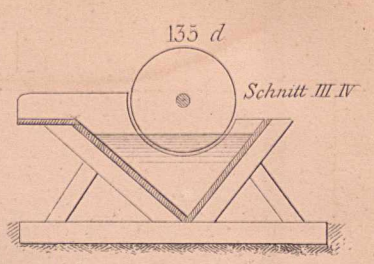
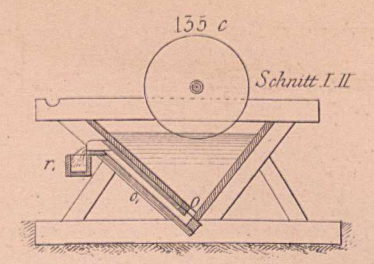
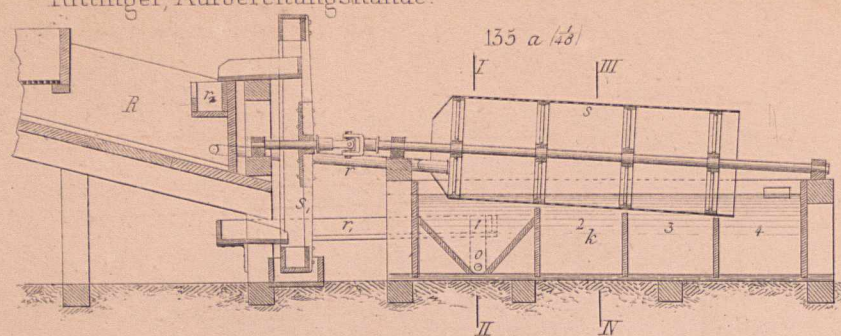

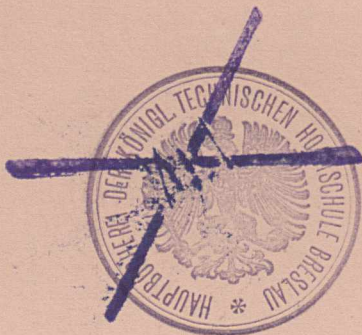

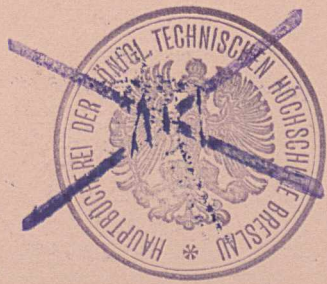

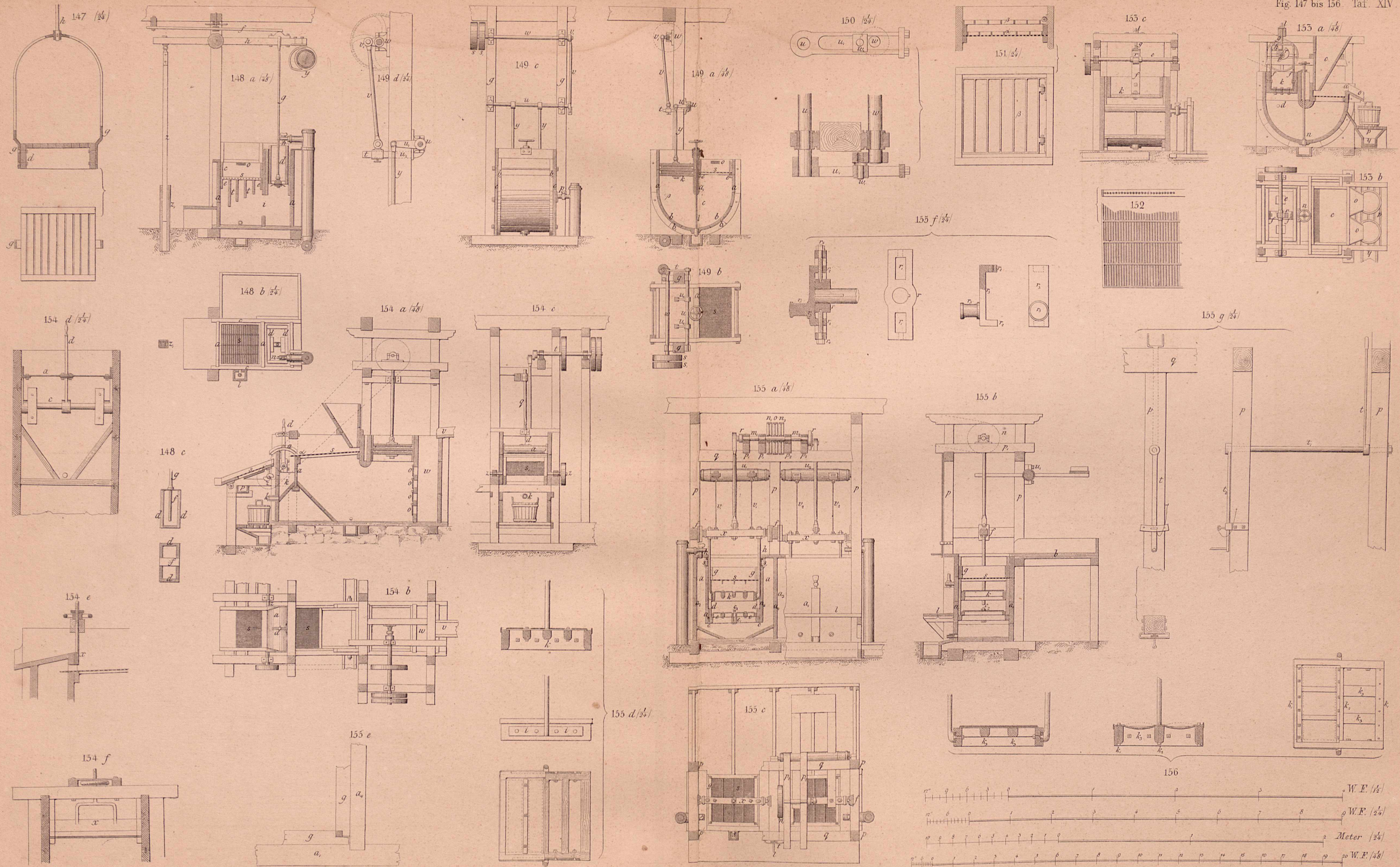

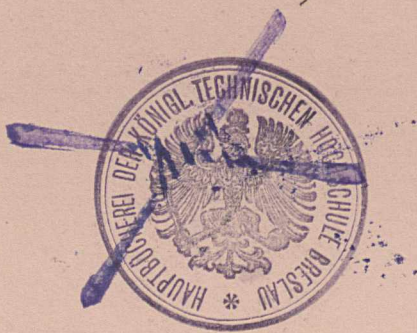



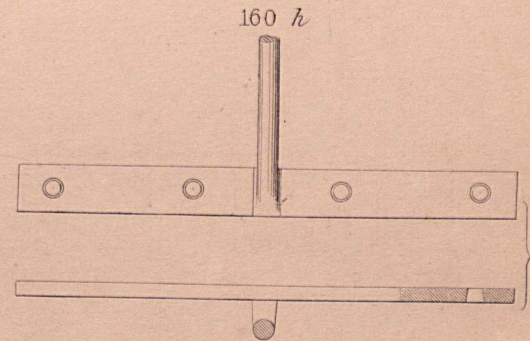
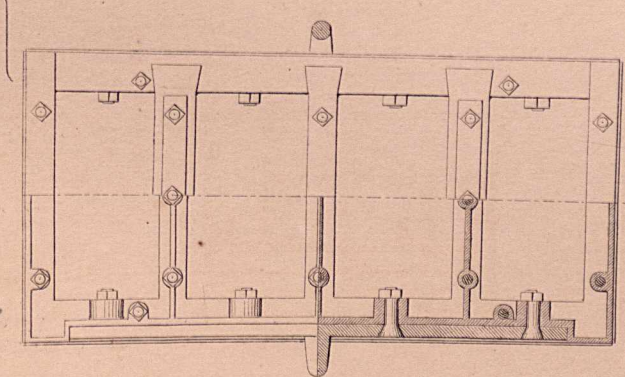
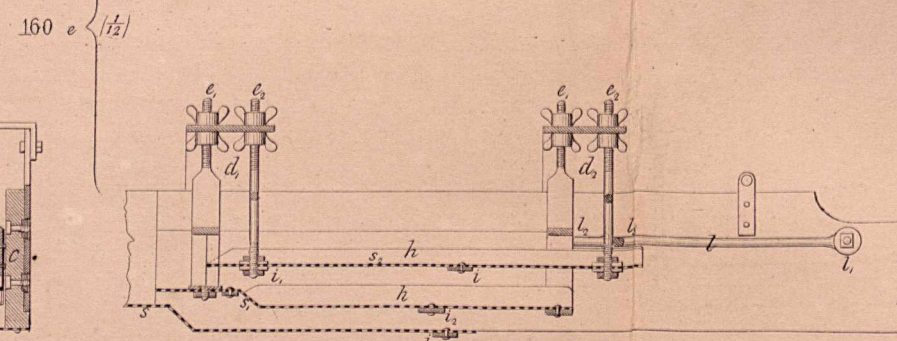
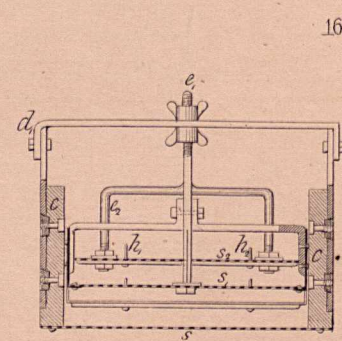
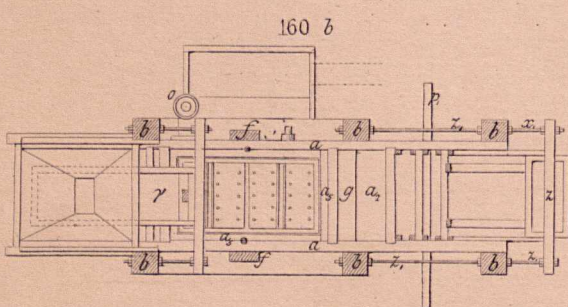
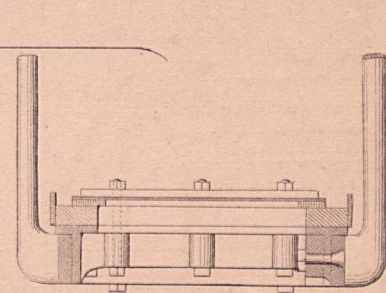
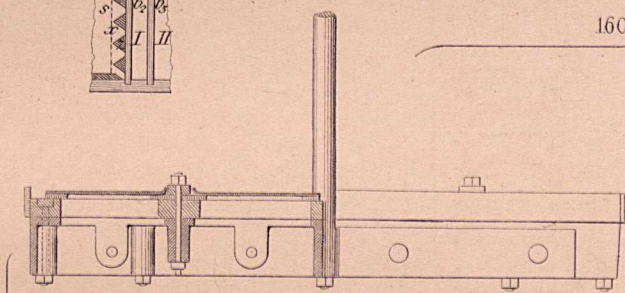
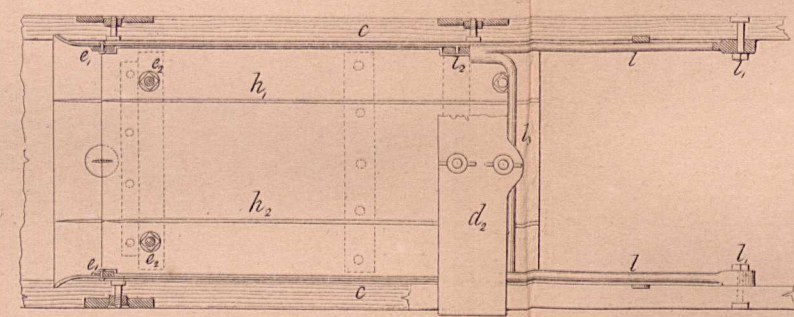
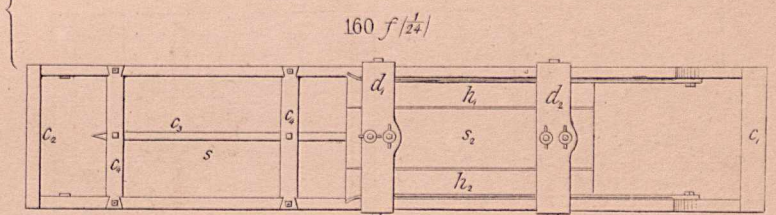
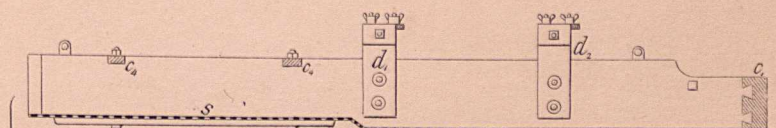
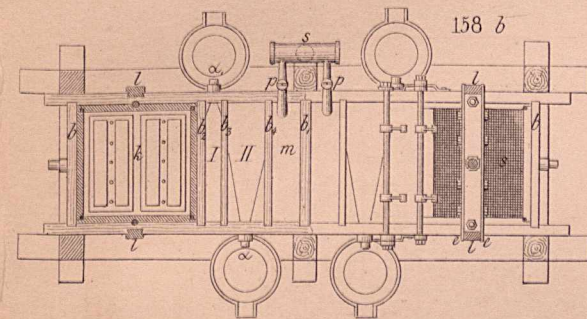
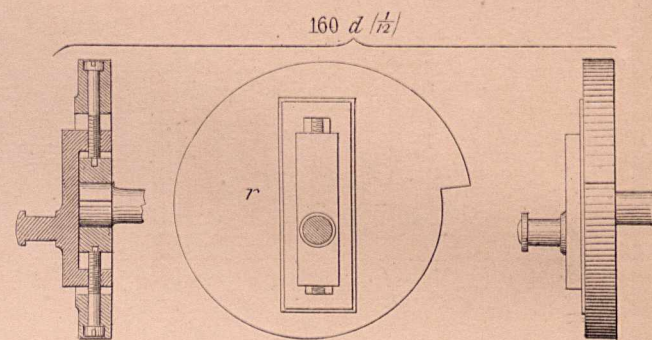
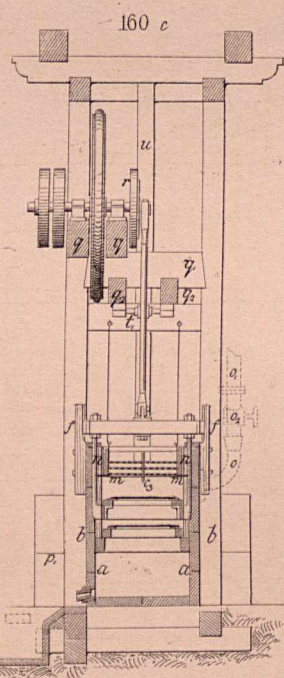
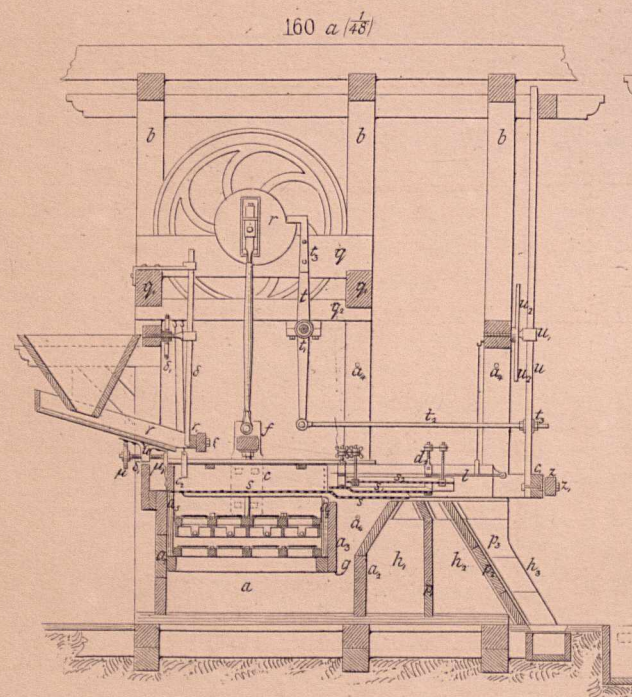
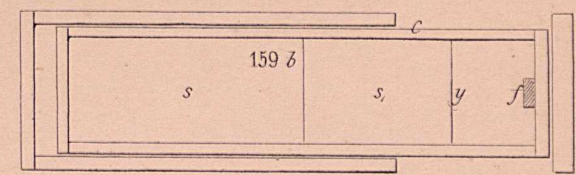
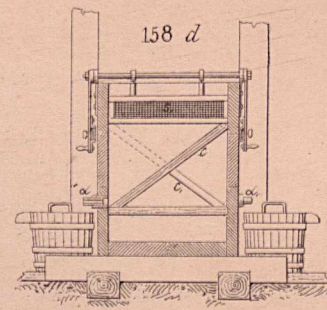
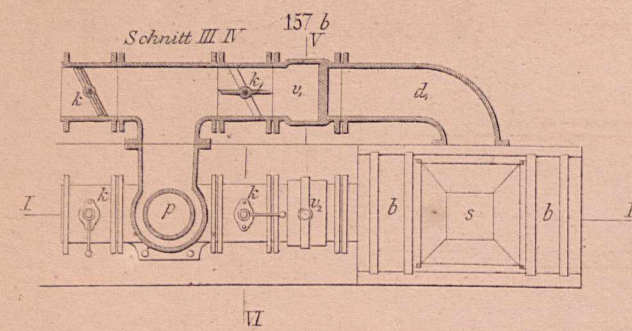
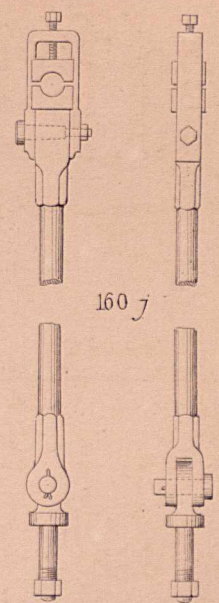
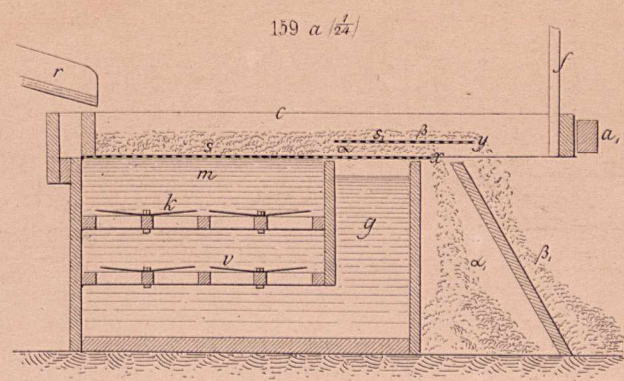
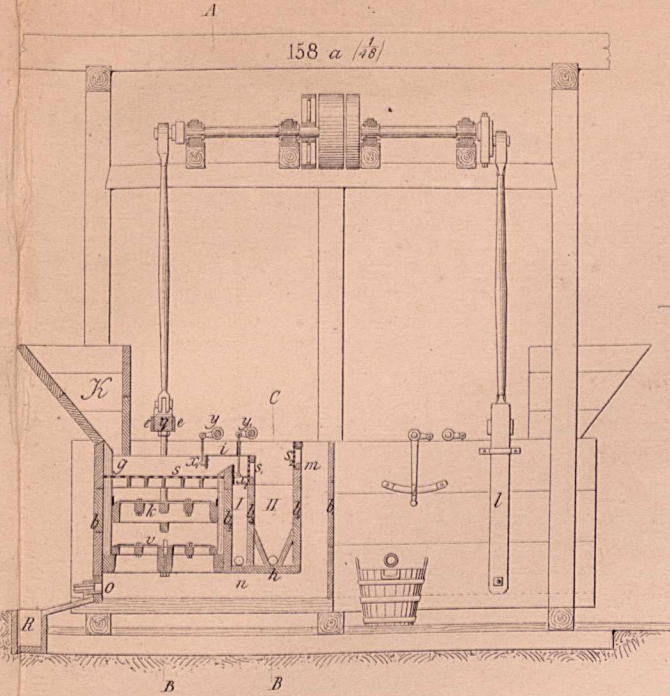
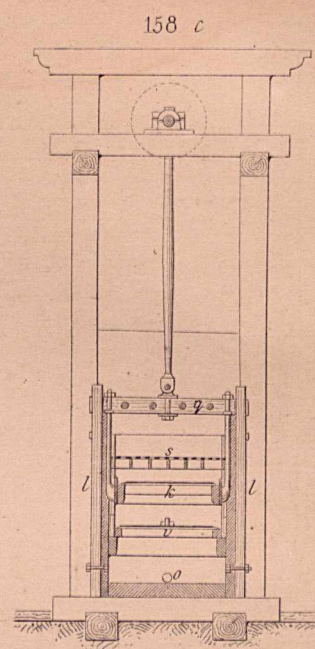
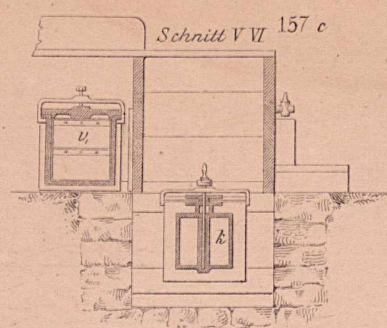
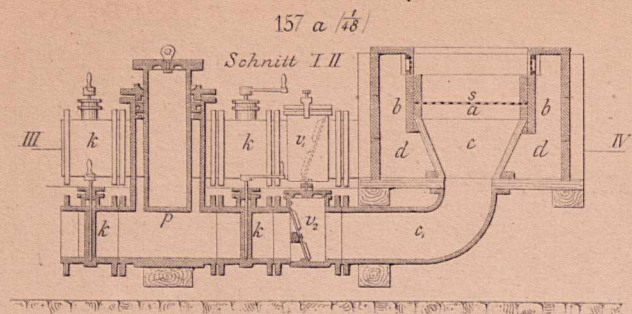

160 i

C					
100	92	87	84	43	30
100	100	77	81	94	54
100	132	152	237	272	300

