

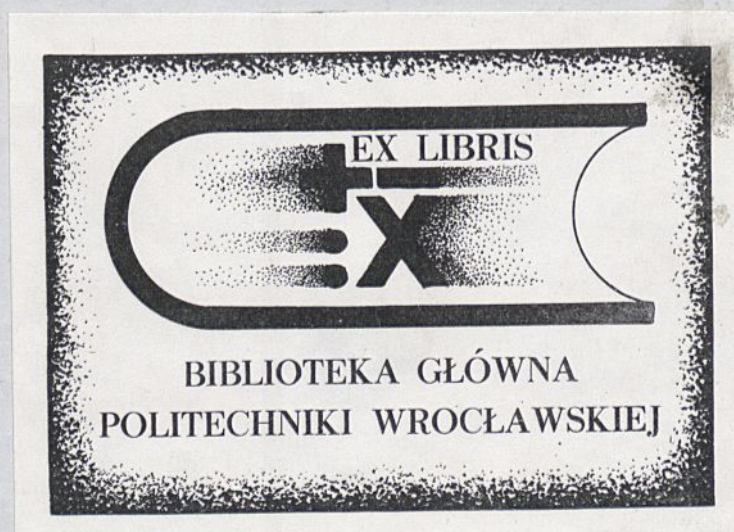

R 96

m

Archiwum







**PUBLICATION INDUSTRIELLE**  
DES  
**MACHINES, OUTILS ET APPAREILS**

**LES PLUS PERFECTIONNÉS ET LES PLUS RÉCENTS**

EMPLOYÉS

DANS LES DIFFÉRENTES BRANCHES DE L'INDUSTRIE FRANÇAISE ET ÉTRANGÈRE

PAR

**ARMENGAUD AINÉ**

INGÉNIEUR, ANCIEN PROFESSEUR AU CONSERVATOIRE IMPÉRIAL DES ARTS ET MÉTIERS

MEMBRE DE LA SOCIÉTÉ D'ENCOURAGEMENT ET DE LA SOCIÉTÉ INDUSTRIELLE DE MULHOUSE

—••—  
*1912. 499.*  
TOME NEUVIÈME

—••—  
**PLANCHES**  
—••—

PARIS

**CHEZ L'AUTEUR, 45 RUE SAINT-SÉBASTIEN**

BOULEVARD DES FILLES-DU-CALVAIRE

ET CHEZ LES PRINCIPAUX LIBRAIRES

—  
1855

PUBLICATION INDUSTRIELLE

MACHINES OUTILS ET APPAREILS

LES DIVERS INSTRUMENTS ET APPAREILS

EXPOSITION

DANS LES DIFFERENTES BRANCHES DE L'INDUSTRIE MANUFACTURIERE ET ARTISANALE



No. 24924.

PARIS

CHATELAIN, 10, RUE DE LA HARPE, PARIS

1889

ET LES BUREAUX DE LA SOCIETE

1889

# TABLE DES PLANCHES

## DU TOME NEUVIÈME DE LA PUBLICATION INDUSTRIELLE

PLANCHES.	1 <sup>re</sup> LIVRAISON.	PAGES.	PLANCHES.	6 <sup>e</sup> LIVRAISON.	PAGES.
1	} Presse monétaire continue de M. Thonnelier, perfectionnée et construite par MM. CAIL et C <sup>e</sup> .	1	21	Machines à vapeur, par M. BOURDON. — Chaudière, par M. CAIL.	259
2			22	Métiers à filer continus et Mull-jennys, avec broches à engrenages, par M. MULLER.	270
3	Construction des machines. — Proportions des garnitures et boîtes à étoupes	20	23	Conservation et emmagasinage des grains, par M. HUART.	286
4	Moulin pour le traitement du riz, par M. BOYER.	36	24	Viaduc en fonte, de Nevers, par MM. BOUCAUMONT et DE MARNE.	313
2 <sup>e</sup> LIVRAISON.			7 <sup>e</sup> LIVRAISON.		
5	Appareils pour le traitement du riz, par M. BOYER.	36	25	Viaduc de Frouard. — Échafauds et mécanisme de levage, par M. KRAFFT.	323
6	Machine à raboter les voussoirs de ponts en fonte, par M. BOURDON.	51	26	Machine à rogner le papier et le carton.	332
7	Machine à apprêter les étoffes, par MM. HUGUENIN, DUCOMMUN et DUBIED.	56	27	Appareil continu à laver, nettoyer et sécher les grains, par M. BARON.	342
8	<i>Le Chamois</i> , navire à roues excentriques, par M. NILLUS.	73	28	Fabrication mécanique des charbons artificiels.	350
3 <sup>e</sup> LIVRAISON.			8 <sup>e</sup> LIVRAISON.		
9	<i>Le Chamois</i> , navire à roues excentriques, par M. NILLUS.	106	29	} Fabrication mécanique des charbons artificiels. — Broyeurs et mélan- geurs. — Machines à mouler. — Fours à carbonisation.	361
10	Fabrication de la monnaie. — Machine à cordonner les flans.	114	30		
11	Scierie mécanique à plusieurs lames, par MM. MAZELINE frères.	121	31	Machine à vapeur à trois cylindres, par M. LEGAVRIAN.	383
12	Gare des marchandises de l'Ouest, par M. FLACHAT.	131	32	Construction des machines. — Dimensions des poulies.	398
4 <sup>e</sup> LIVRAISON.			9 <sup>e</sup> LIVRAISON.		
13	Gare des marchandises de l'Ouest, par M. FLACHAT.	131	33	Construction des machines. — Dimensions des poulies.	409
14	} Mull-jenny self-acting, ou renvideur mécanique, par M. WEILD, con- struit par MM. GOUIN et C <sup>e</sup> .	150	34	Fabrication de l'alcool des betteraves, par M. CHAMPONNOIS.	441
15			35	Appareils de sûreté. Distribution et détente dans les cylindres à vapeur.	460
16	Construction des machines. — Proportions des engrenages.	171	36	Appareils de niveau d'eau. Tiroirs de distribution.	471
5 <sup>e</sup> LIVRAISON.			10 <sup>e</sup> LIVRAISON.		
17	Construction des machines. — Proportions des engrenages.	193	37	Chauffage à eau chaude. — Serre et orangerie.	480
18	Fabrication de l'acier fondu, par MM. JAMES JACKSON et fils.	211	38	Appareils à rogner et à polir les bougies stéariques, et à tresser les mèches.	491
19	Moulins à blé commandés par le haut, par M. DARBLAY et M. BARON.	230	39	Machine à battre les grains, par M. LORIOT. — Machine anglaise.	500
20	Machines à vapeur horizontales accouplées, par M. BOURDON.	238	40	Appareil d'évaporation à double et à triple effet, par MM. CAIL et C <sup>e</sup> .	512

TABLA DES MATIERES

TABLE DES MATIERES

1	1	1	1
2	2	2	2
3	3	3	3
4	4	4	4
5	5	5	5
6	6	6	6
7	7	7	7
8	8	8	8
9	9	9	9
10	10	10	10
11	11	11	11
12	12	12	12
13	13	13	13
14	14	14	14
15	15	15	15
16	16	16	16
17	17	17	17
18	18	18	18
19	19	19	19
20	20	20	20
21	21	21	21
22	22	22	22
23	23	23	23
24	24	24	24
25	25	25	25
26	26	26	26
27	27	27	27
28	28	28	28
29	29	29	29
30	30	30	30
31	31	31	31
32	32	32	32
33	33	33	33
34	34	34	34
35	35	35	35
36	36	36	36
37	37	37	37
38	38	38	38
39	39	39	39
40	40	40	40
41	41	41	41
42	42	42	42
43	43	43	43
44	44	44	44
45	45	45	45
46	46	46	46
47	47	47	47
48	48	48	48
49	49	49	49
50	50	50	50
51	51	51	51
52	52	52	52
53	53	53	53
54	54	54	54
55	55	55	55
56	56	56	56
57	57	57	57
58	58	58	58
59	59	59	59
60	60	60	60
61	61	61	61
62	62	62	62
63	63	63	63
64	64	64	64
65	65	65	65
66	66	66	66
67	67	67	67
68	68	68	68
69	69	69	69
70	70	70	70
71	71	71	71
72	72	72	72
73	73	73	73
74	74	74	74
75	75	75	75
76	76	76	76
77	77	77	77
78	78	78	78
79	79	79	79
80	80	80	80
81	81	81	81
82	82	82	82
83	83	83	83
84	84	84	84
85	85	85	85
86	86	86	86
87	87	87	87
88	88	88	88
89	89	89	89
90	90	90	90
91	91	91	91
92	92	92	92
93	93	93	93
94	94	94	94
95	95	95	95
96	96	96	96
97	97	97	97
98	98	98	98
99	99	99	99
100	100	100	100





Fig. 1.

Fig. 2.

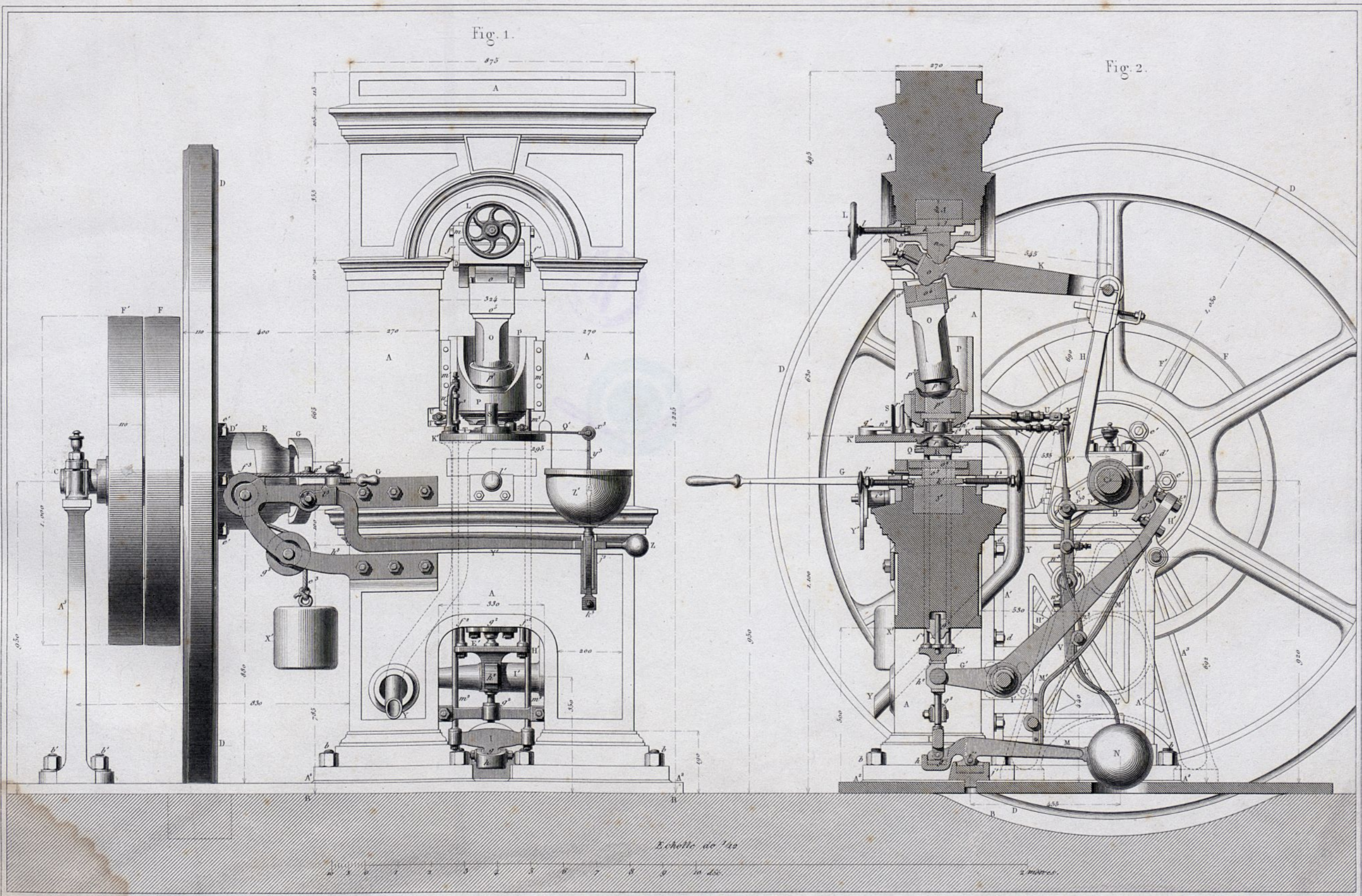

J. Petitecolin, sculp.

Armengaud aîné.







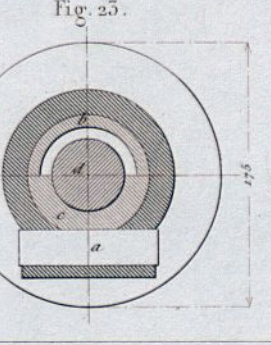
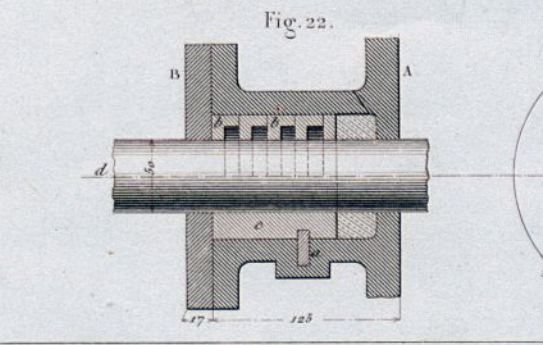
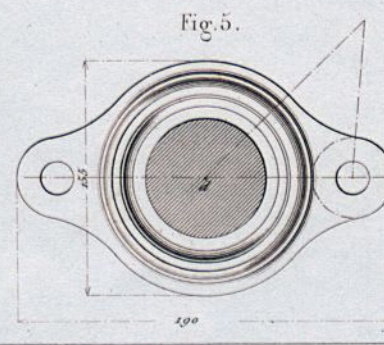
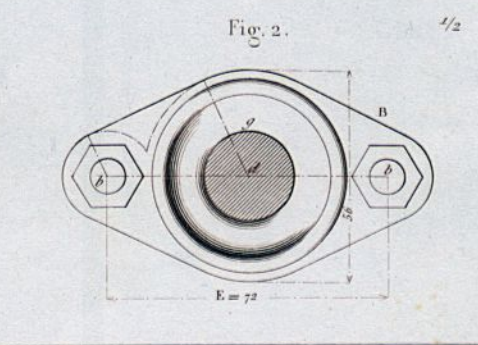
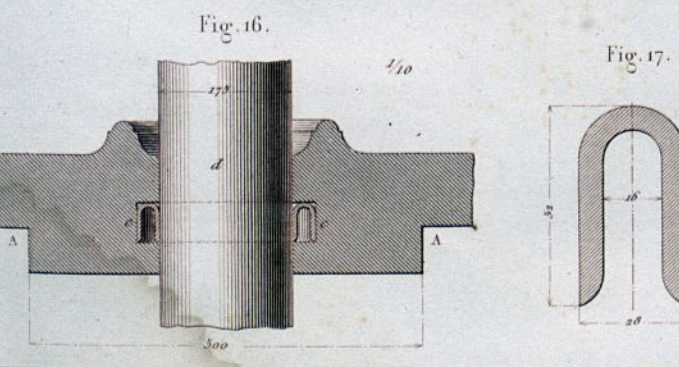
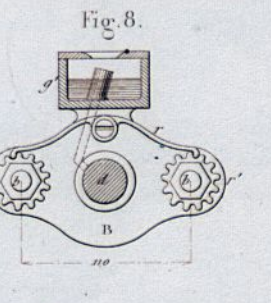
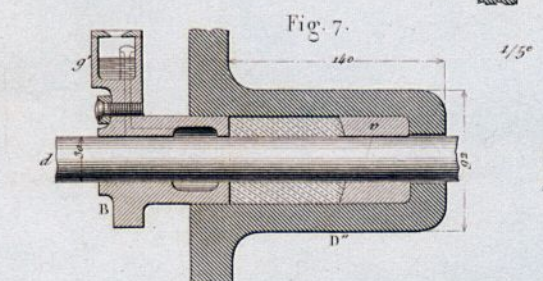
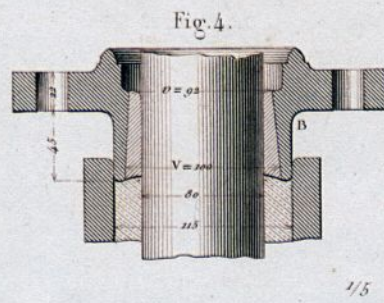
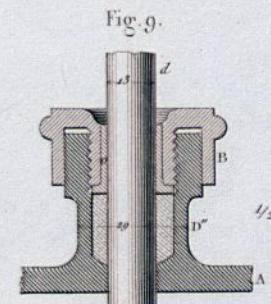
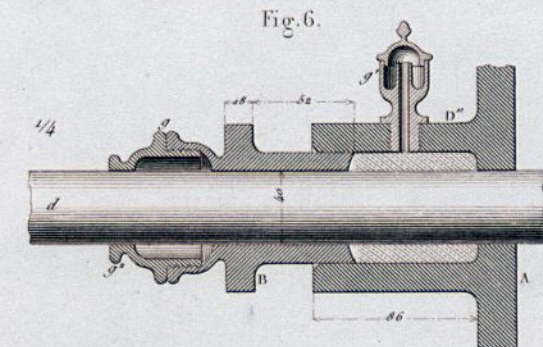
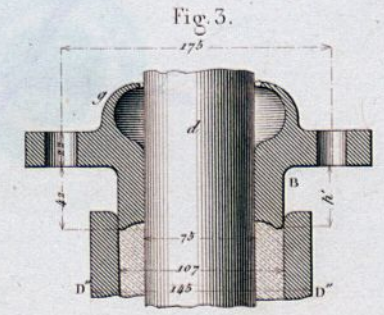
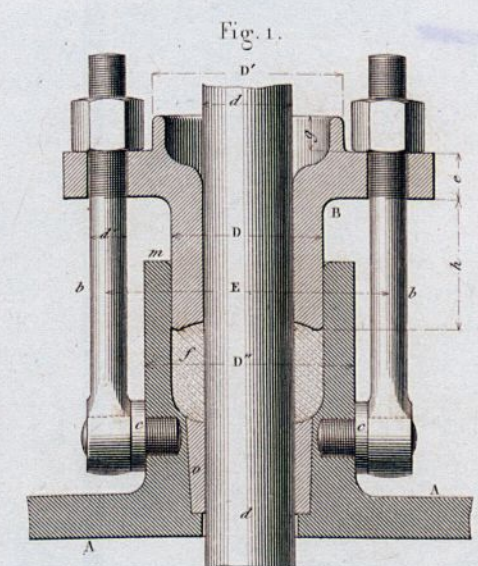
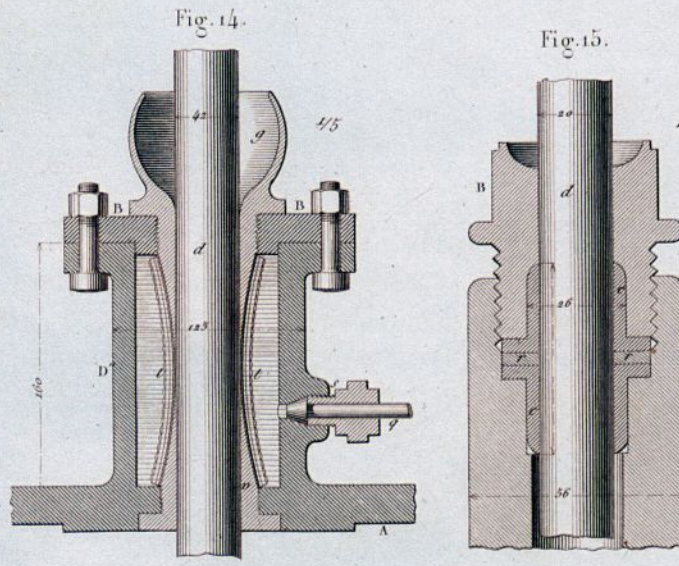
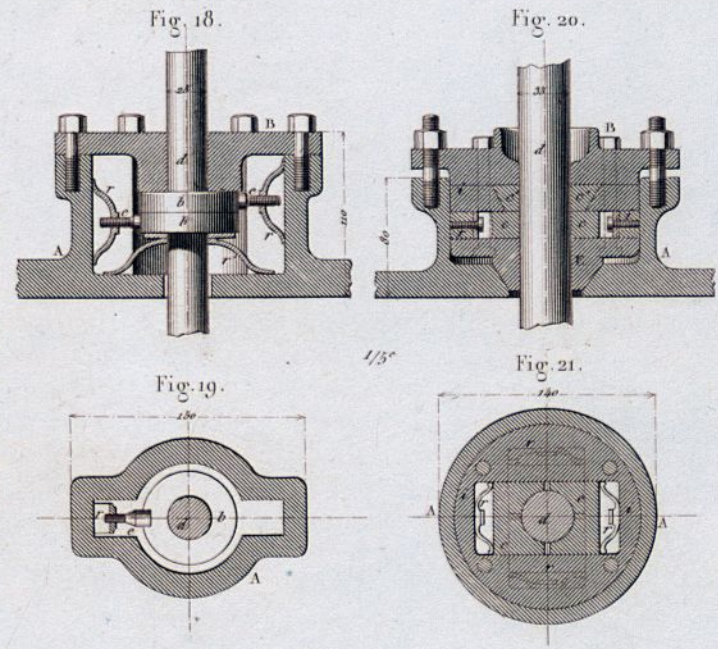
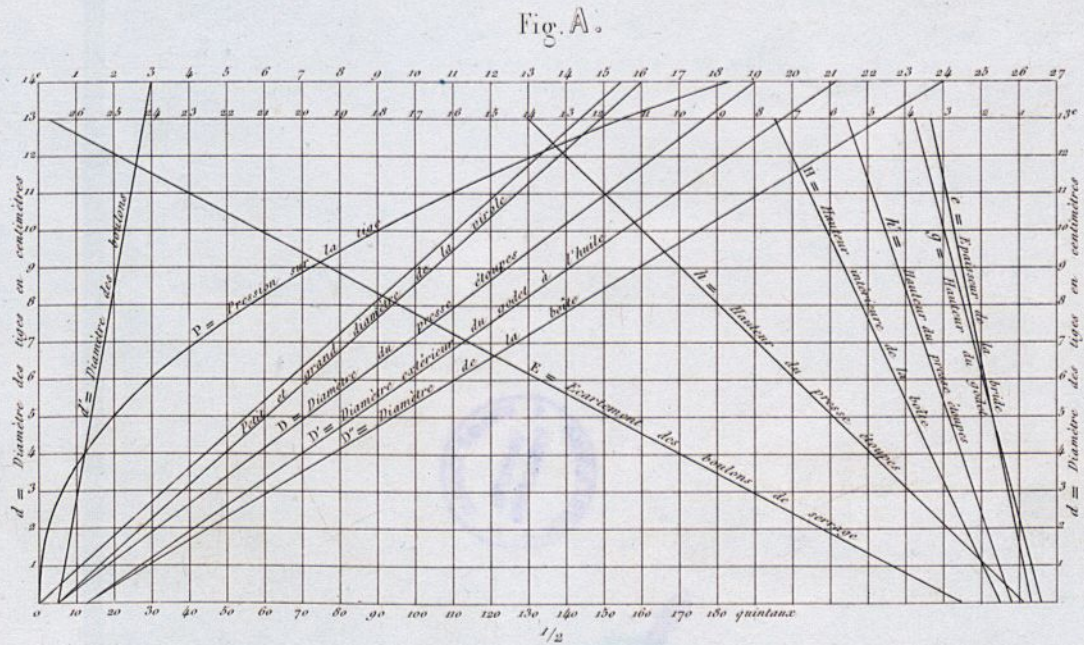
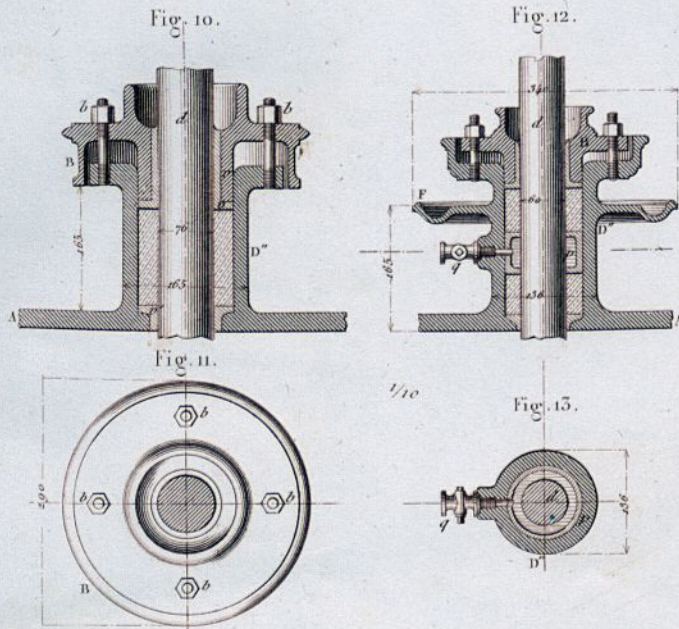

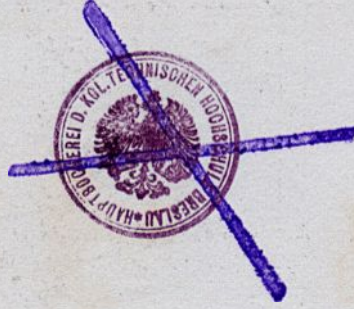
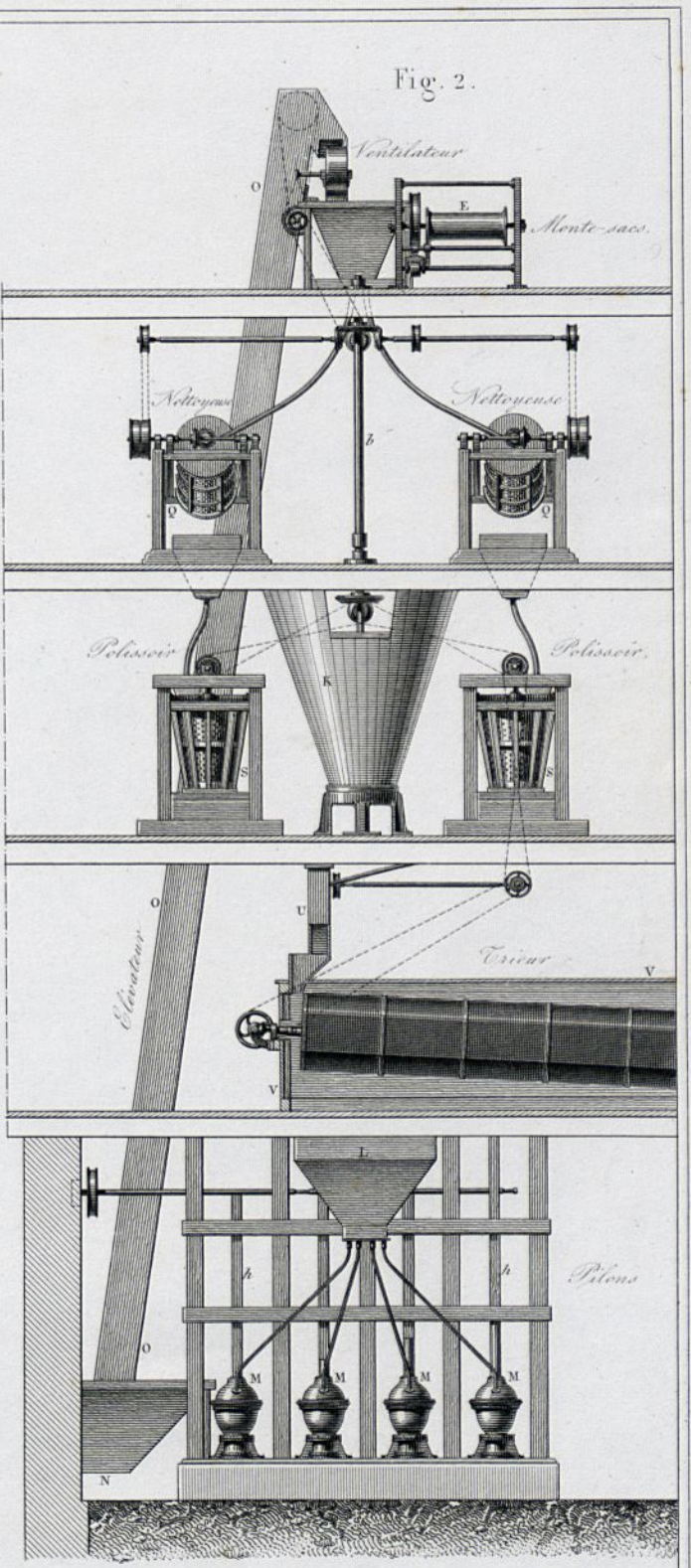
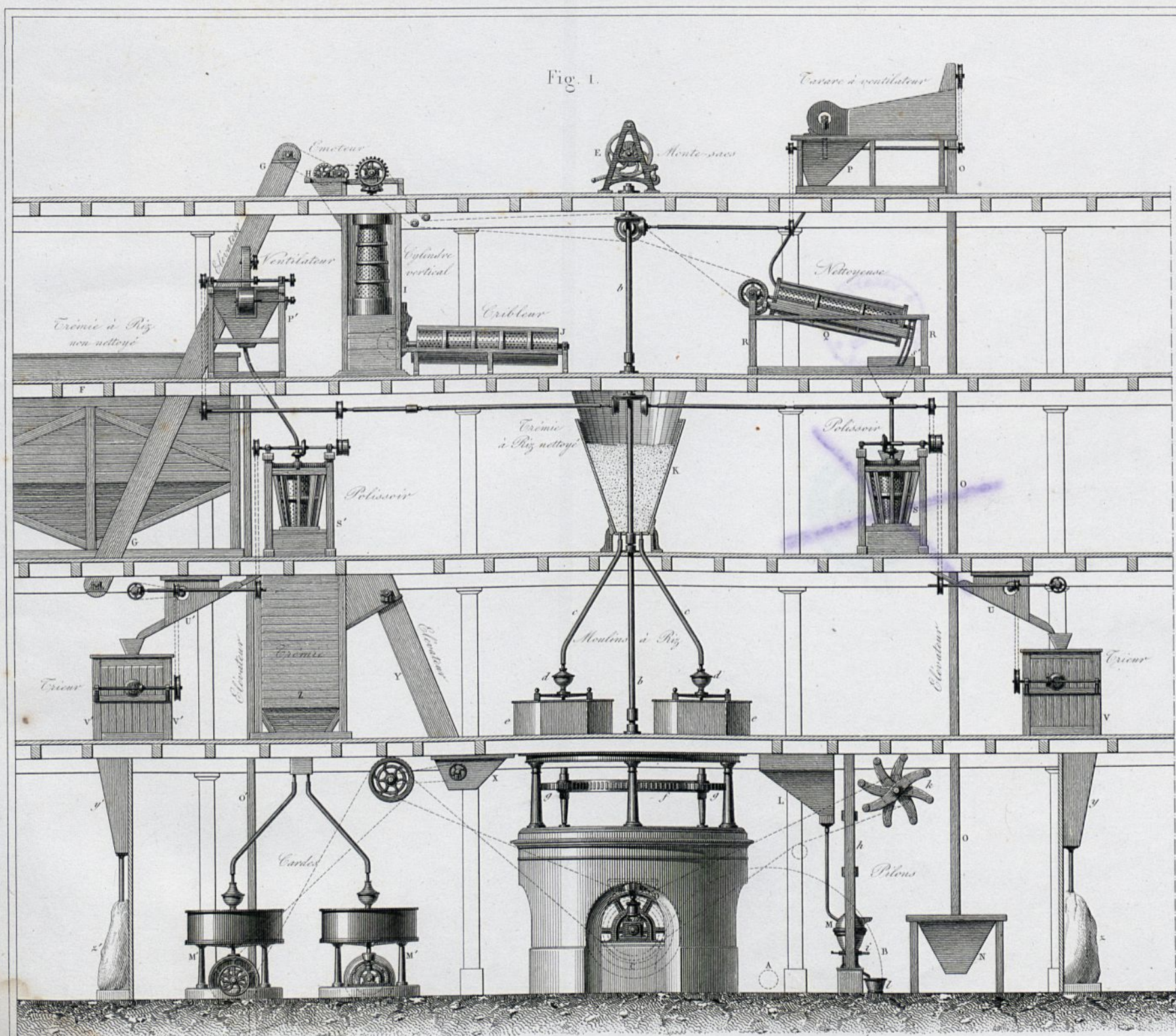

Fig. 1.

Fig. 2.



J. Petitcolin sculp.

Armengaud aîné.

Imp. de F. Chardon aîné, r. Hauteville, 30, Paris.





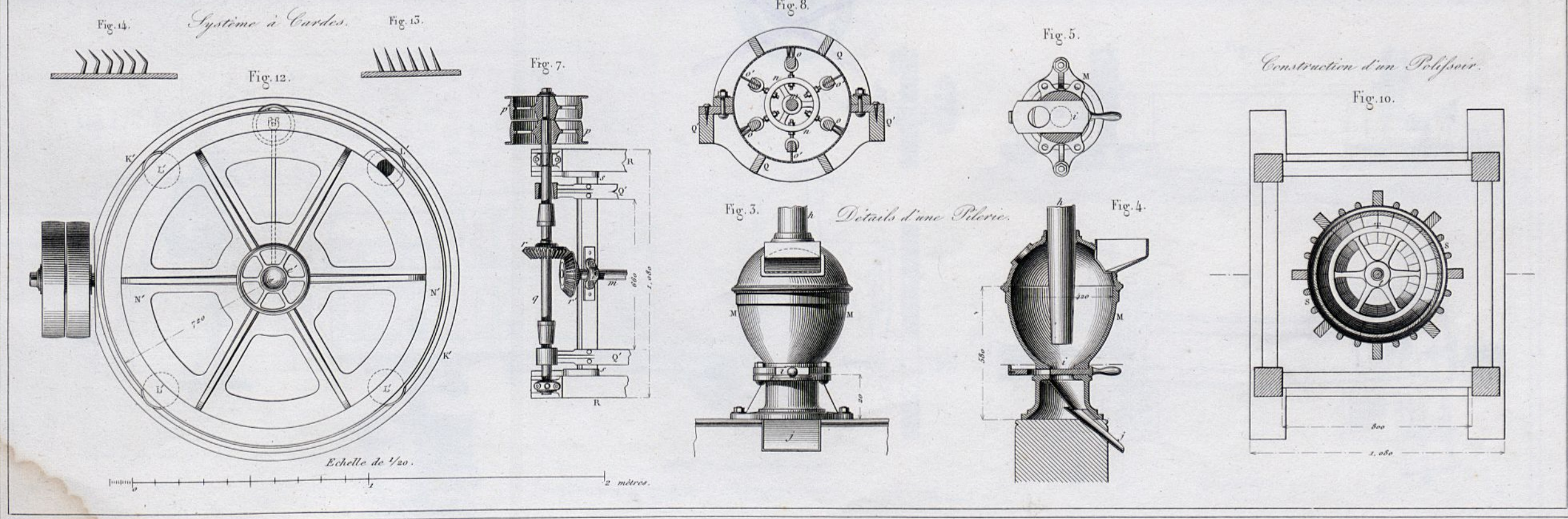
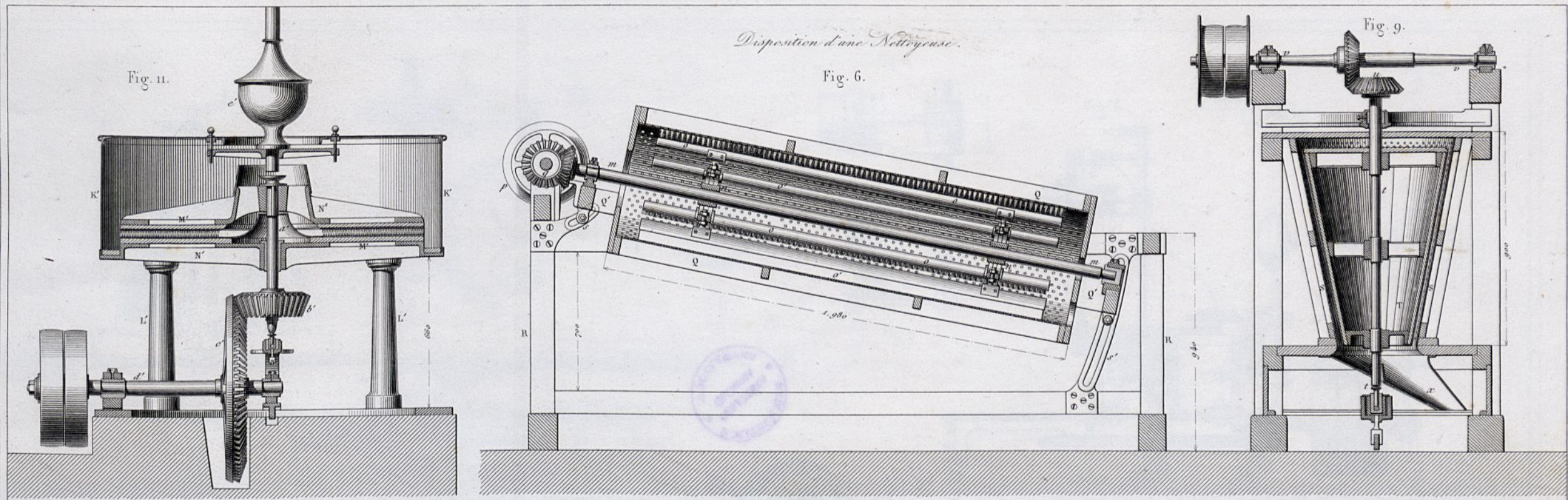



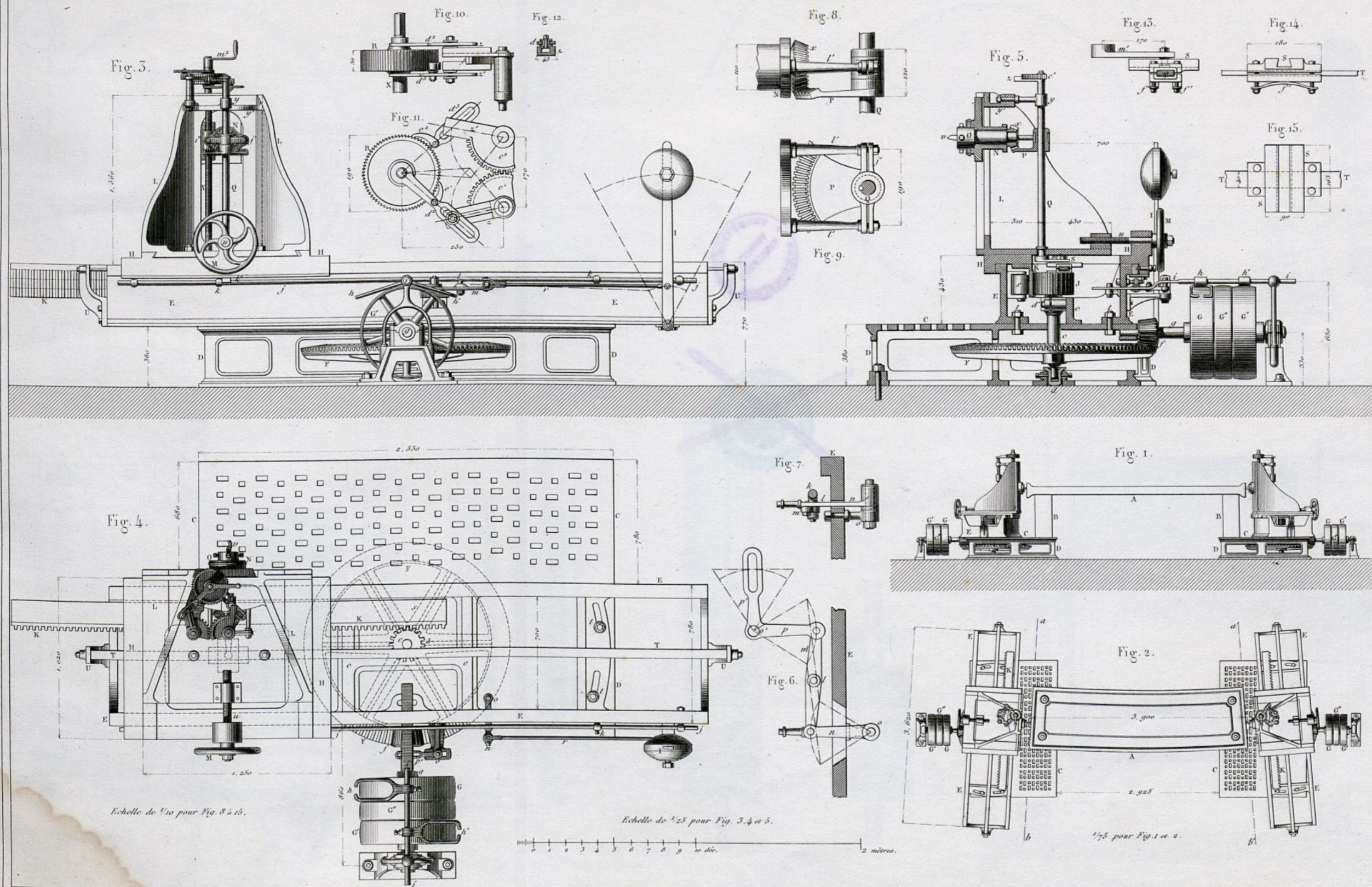



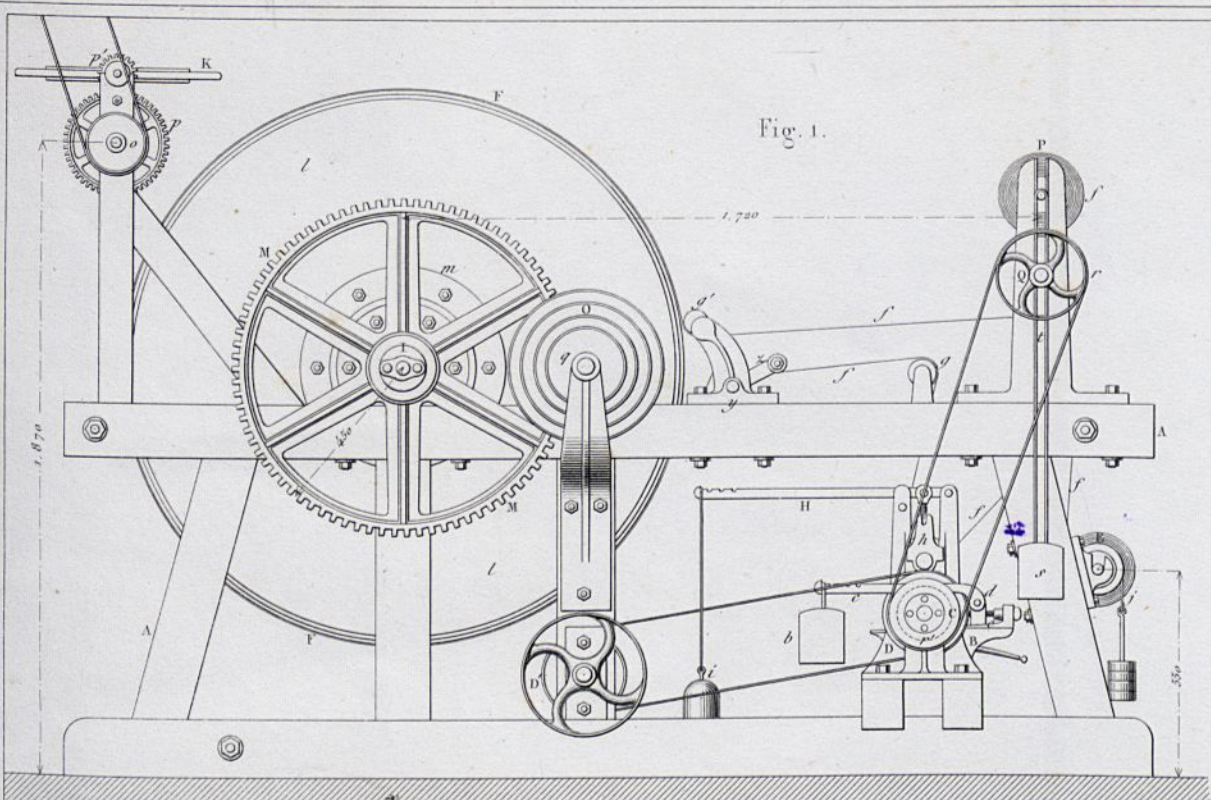

Fig. 1.

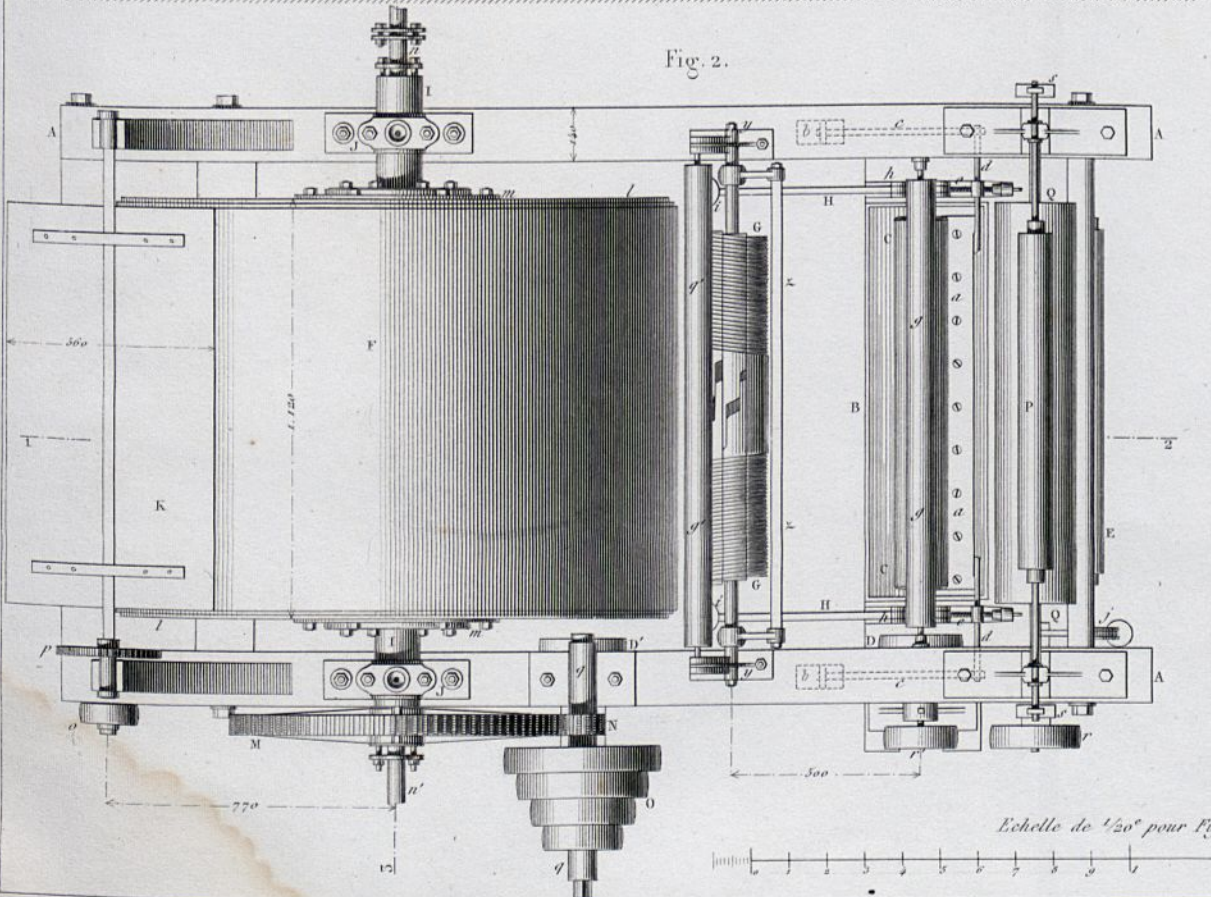

Fig. 2.

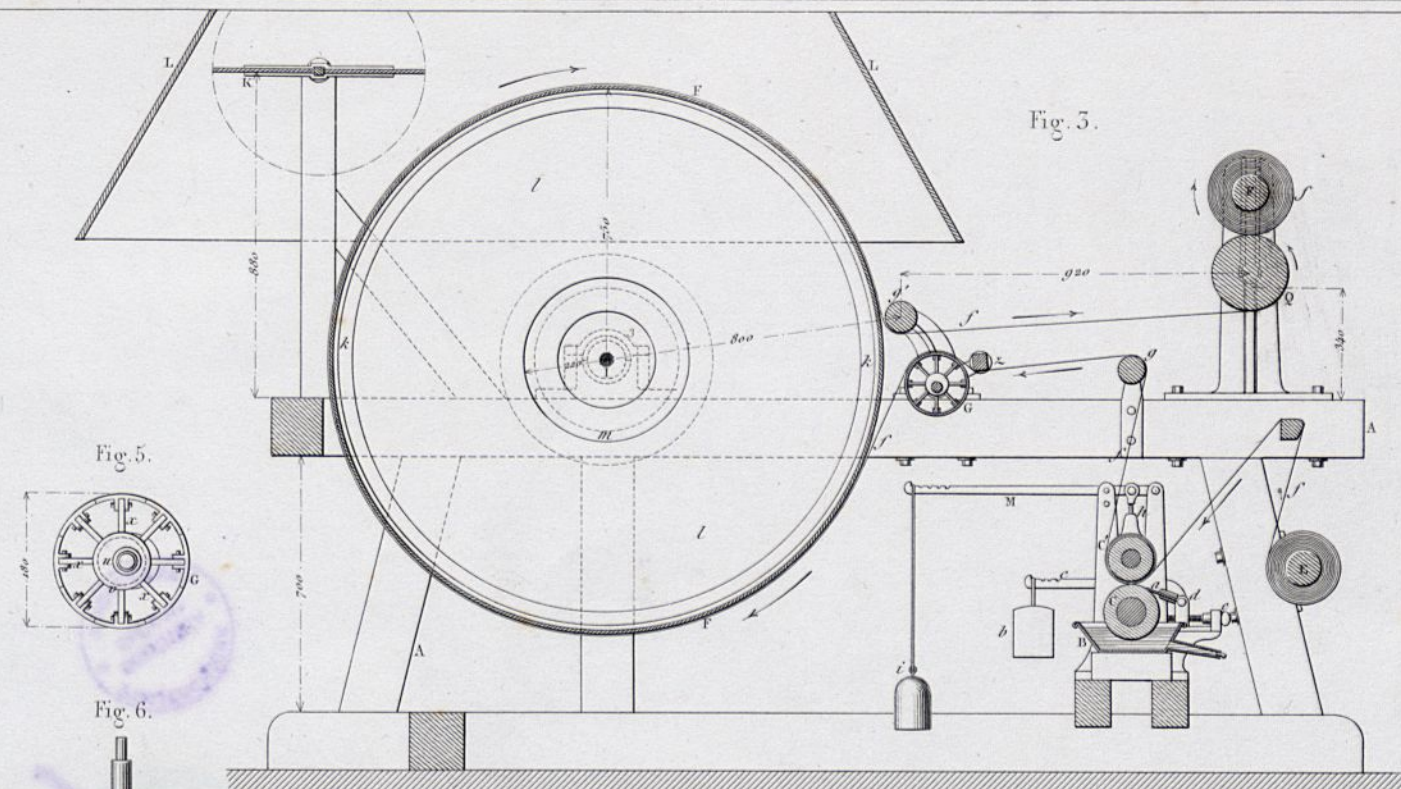

Fig. 3.

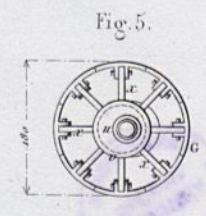

Fig. 5.

Fig. 6.

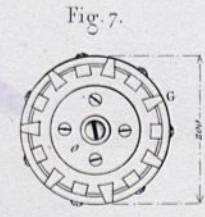
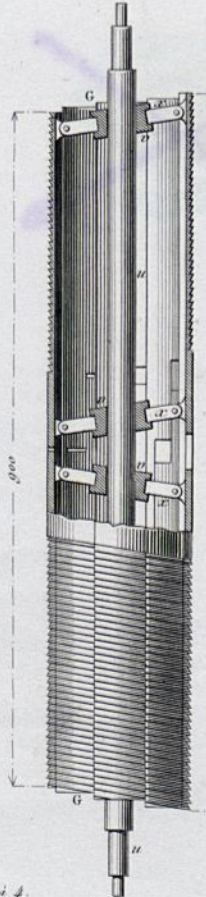

Fig. 7.

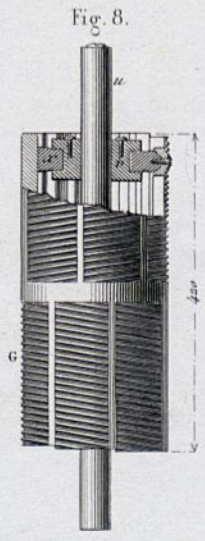

Fig. 8.

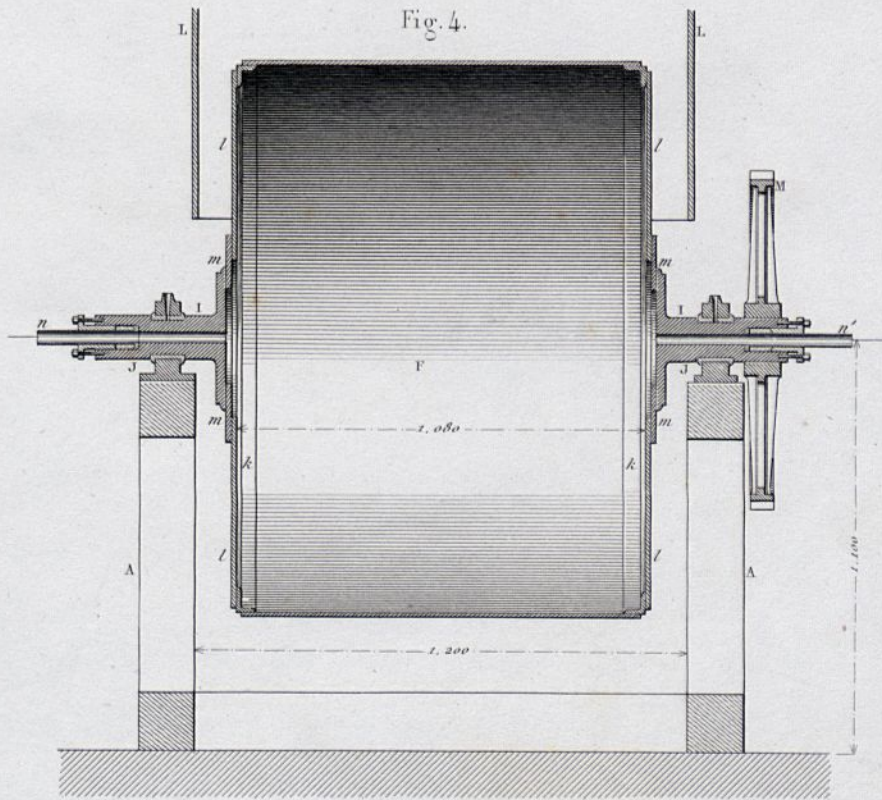

Fig. 4.

Echelle de 1/20<sup>e</sup> pour Fig. 1 à 4.

2 mètres.



*Le Chamois.*

*Elevation.*

Fig. 1.

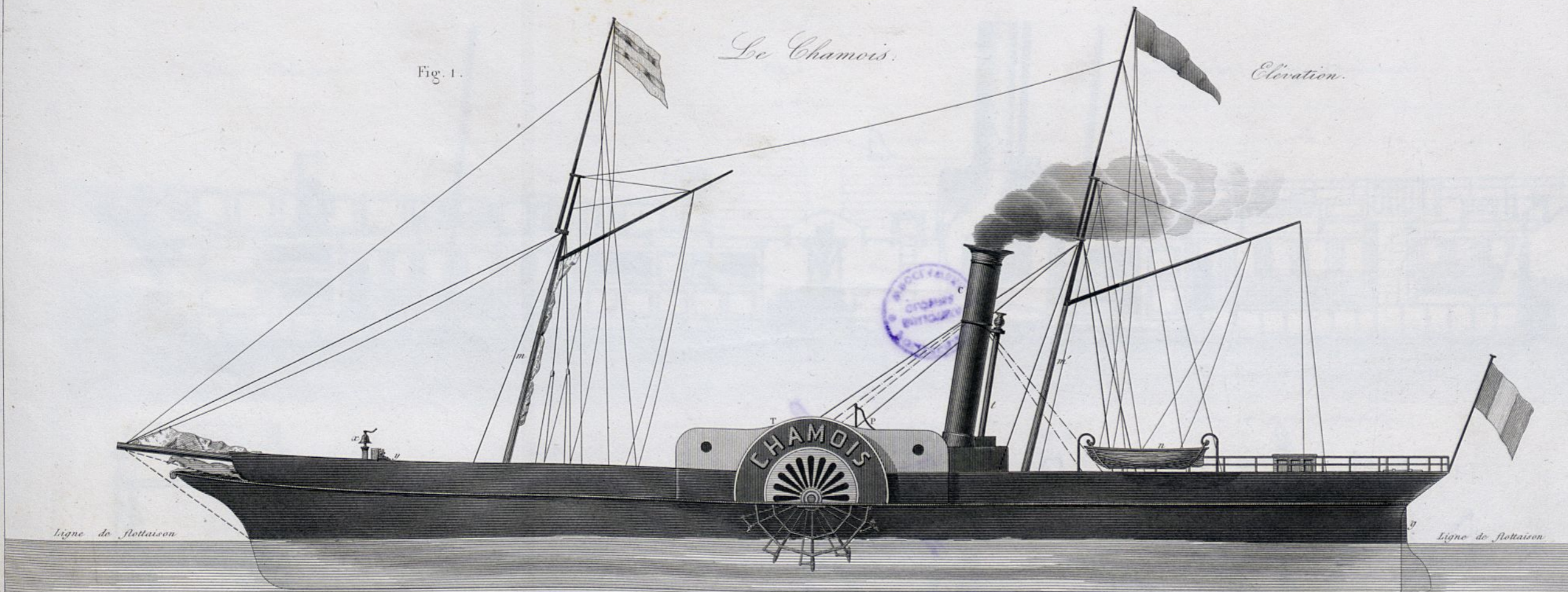

Fig. 2.

*Plan général vu en dessus.*

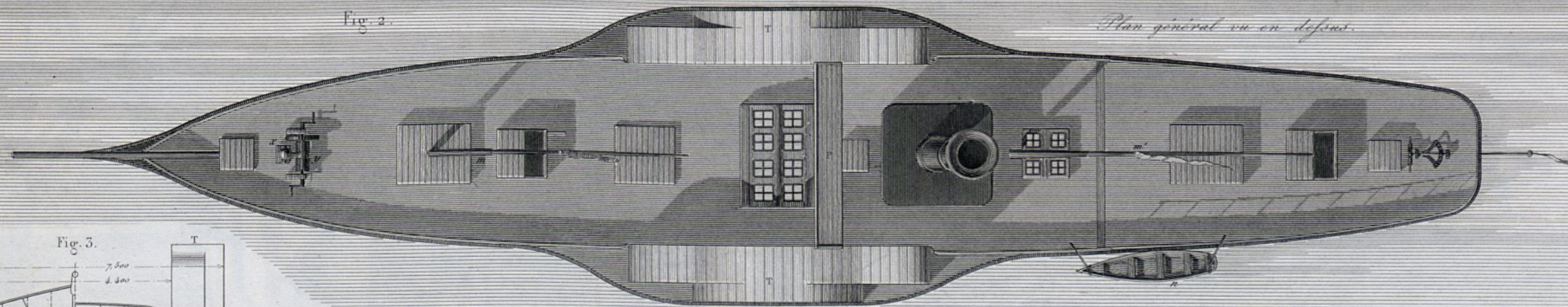
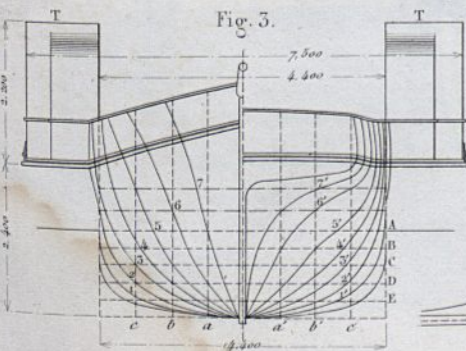
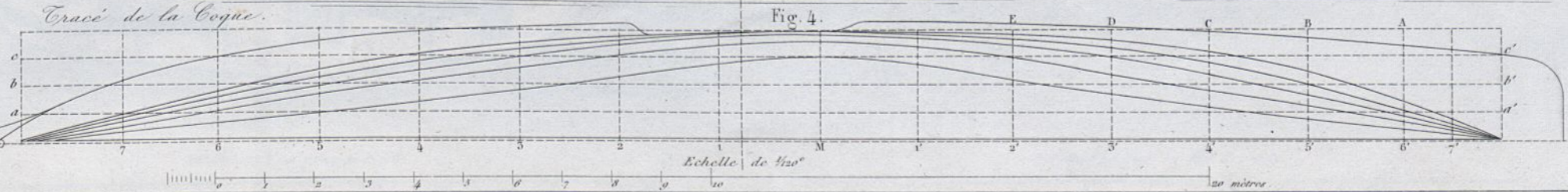

Fig. 3.



*Tracé de la Coque.*

Fig. 4.







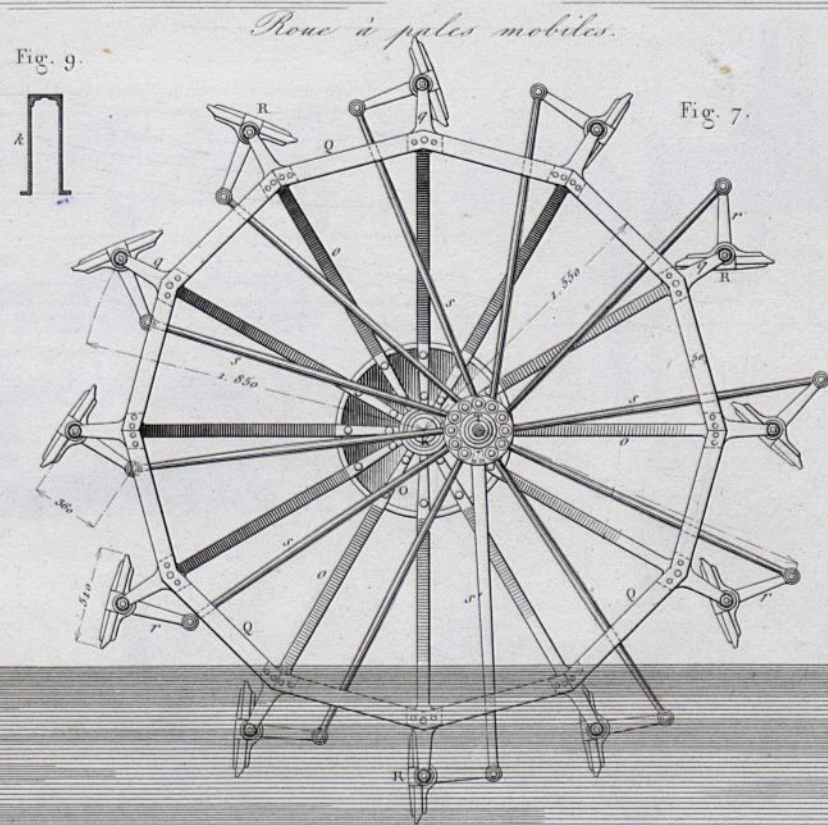
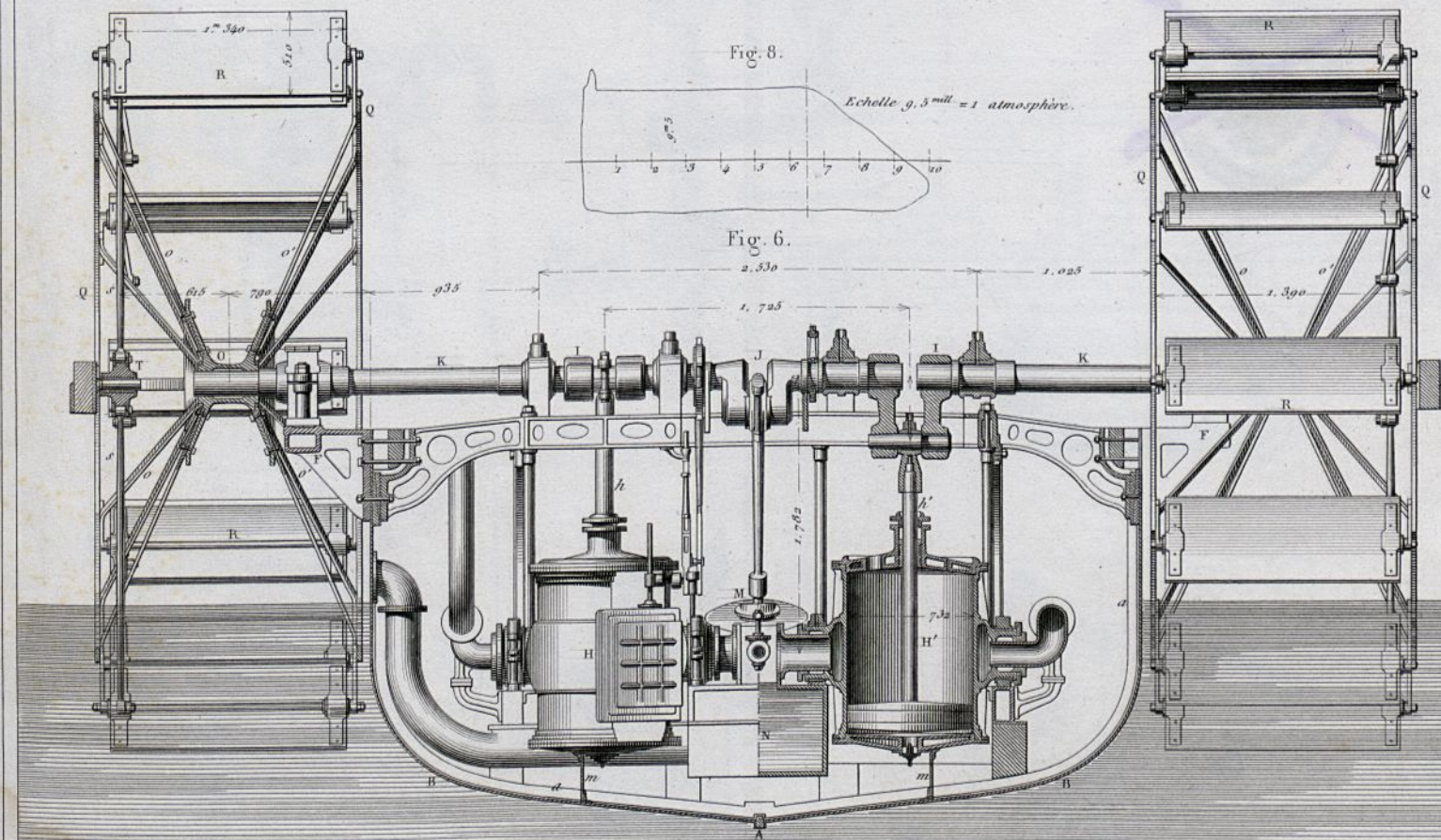
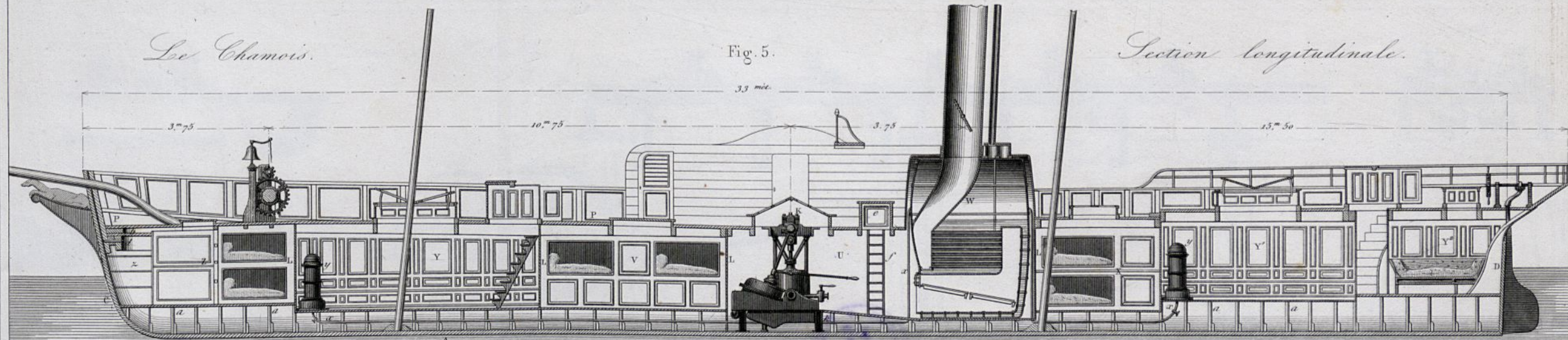

Echelle de 1/100 pour la Fig. 5.

Echelle 1/40 pour les Fig. 6, 7 et 9.



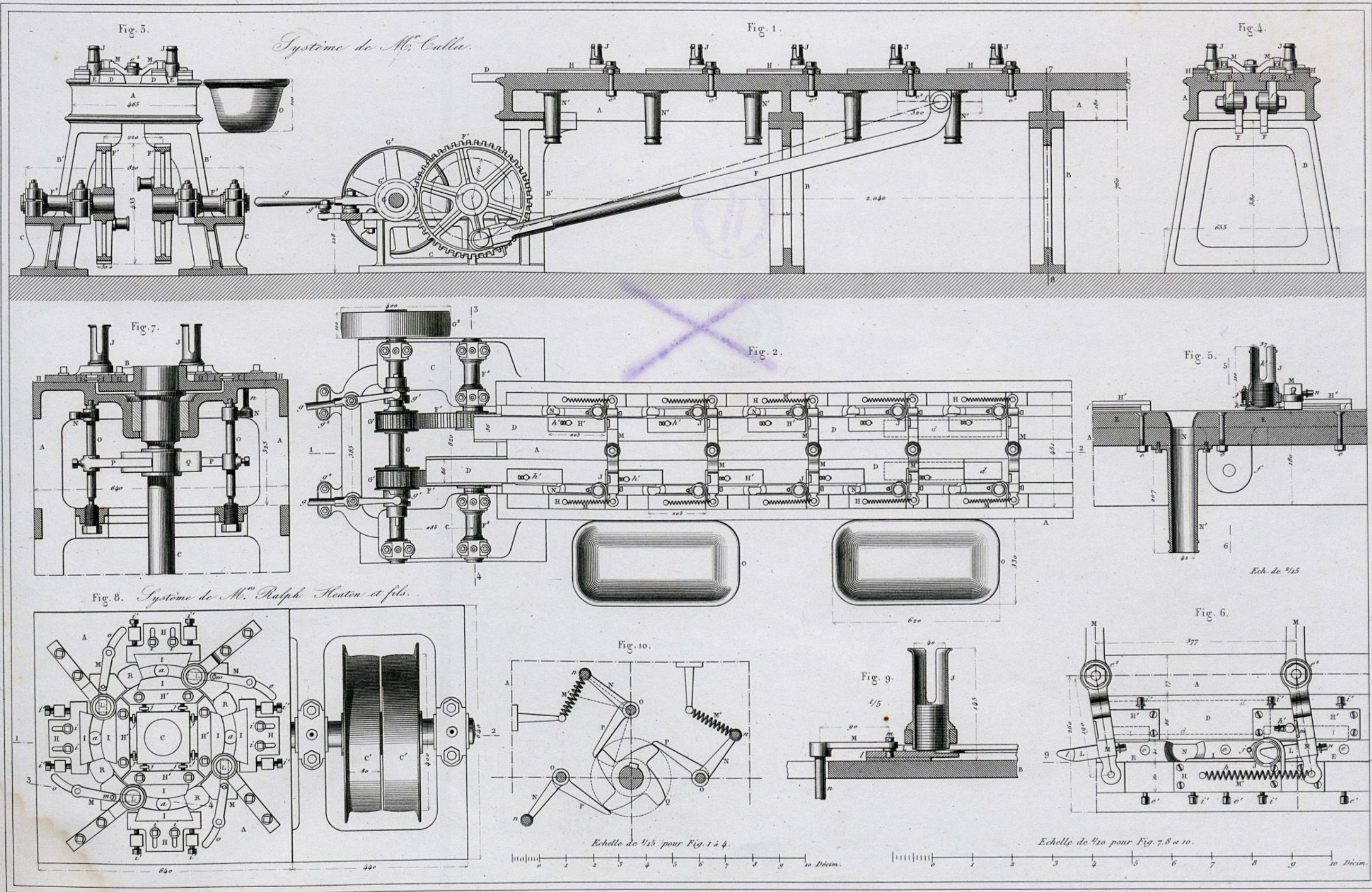







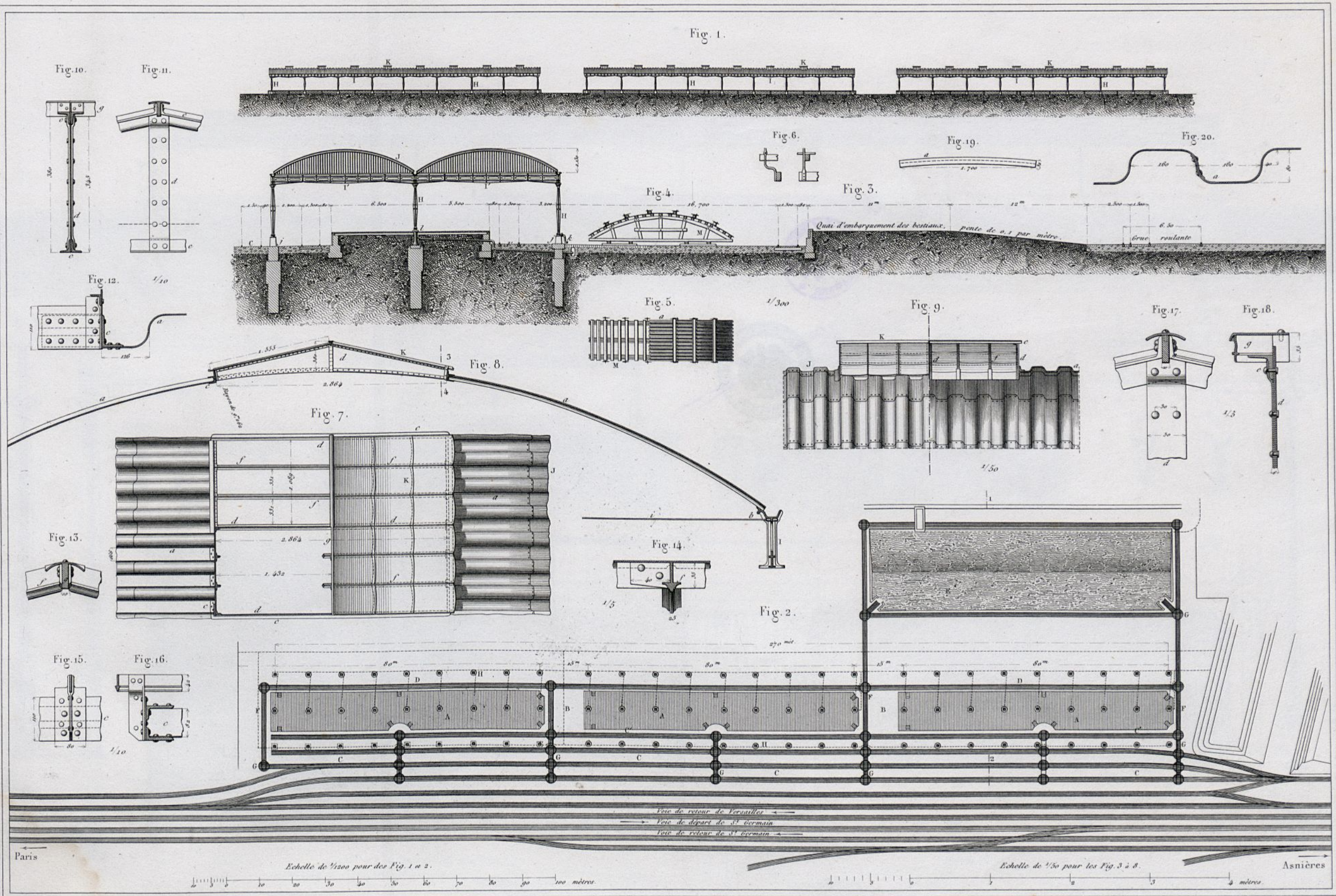





Fig. 21.

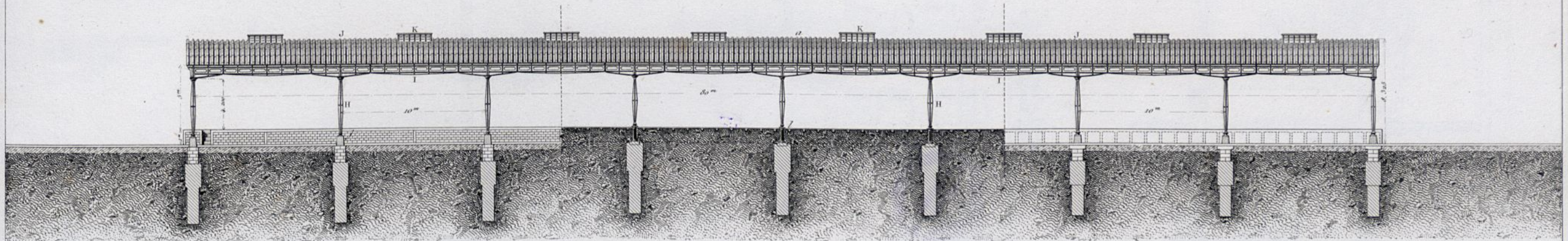

Fig. 26.

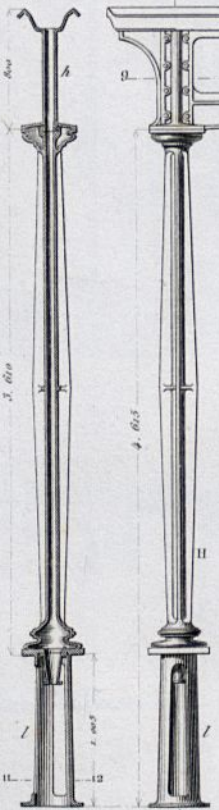

Fig. 25.

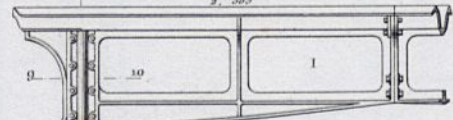

Fig. 58.



Fig. 57.

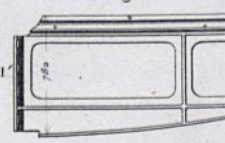

Fig. 25.

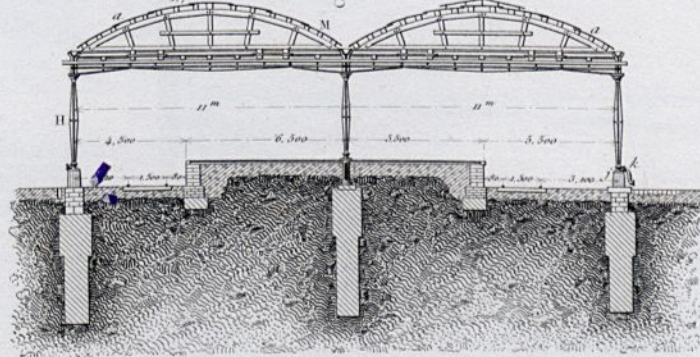

Fig. 24.

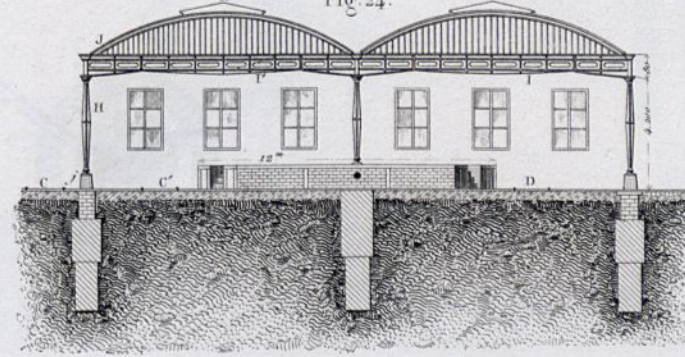

Fig. 20.

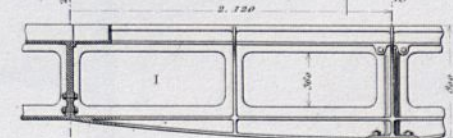

Fig. 50.



Fig. 55.



Fig. 56.



Fig. 22.

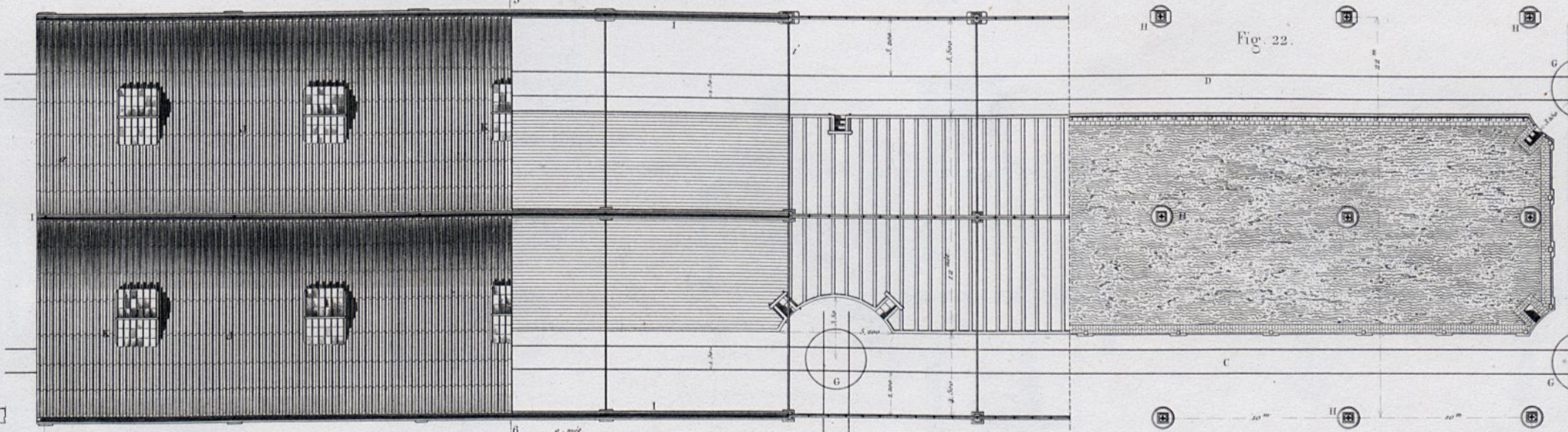

Echelle de 1/300 pour les Fig. 21, 22 et 23.

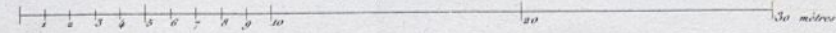

Echelle de 1/50 pour les Fig. 24 à 35.

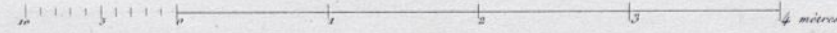



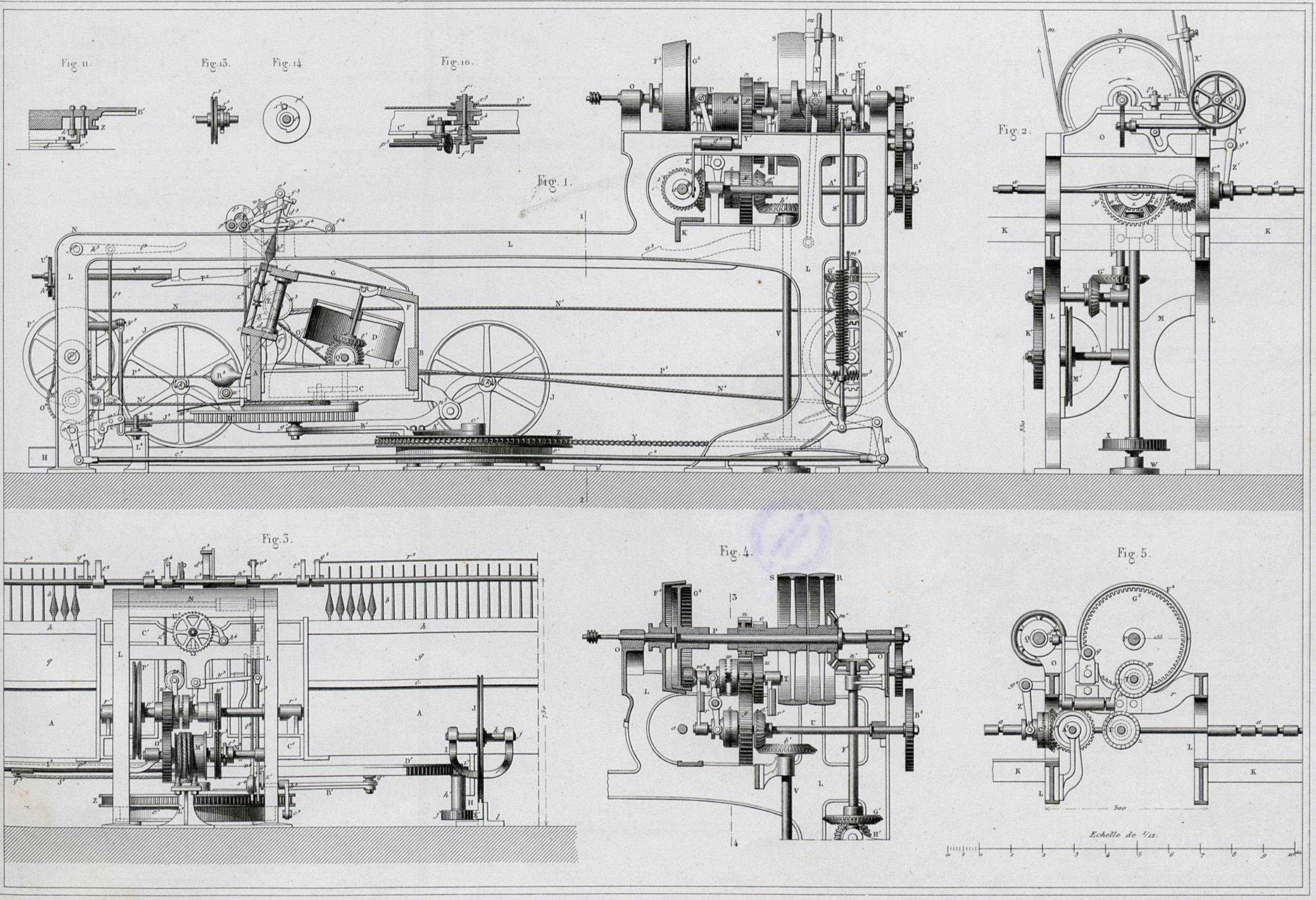



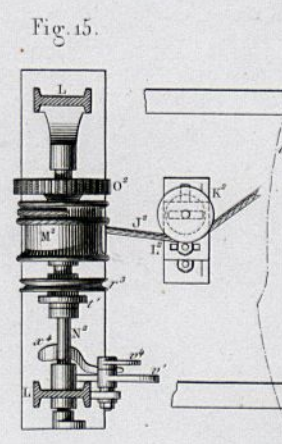
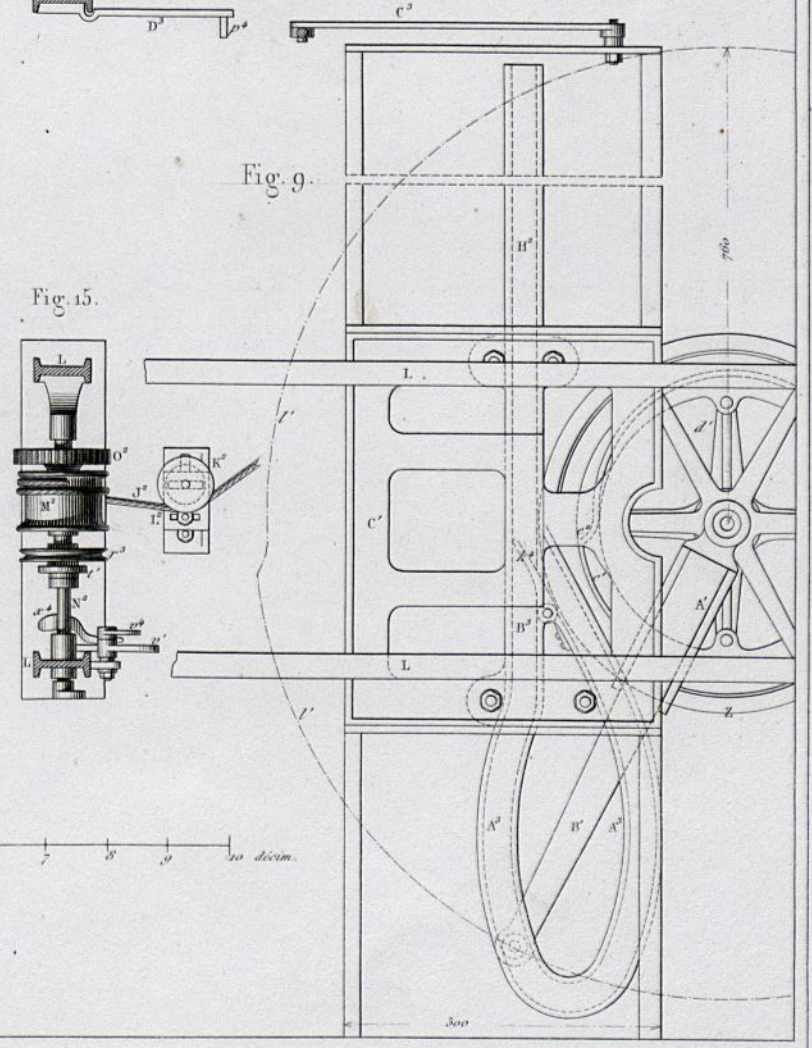
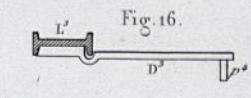
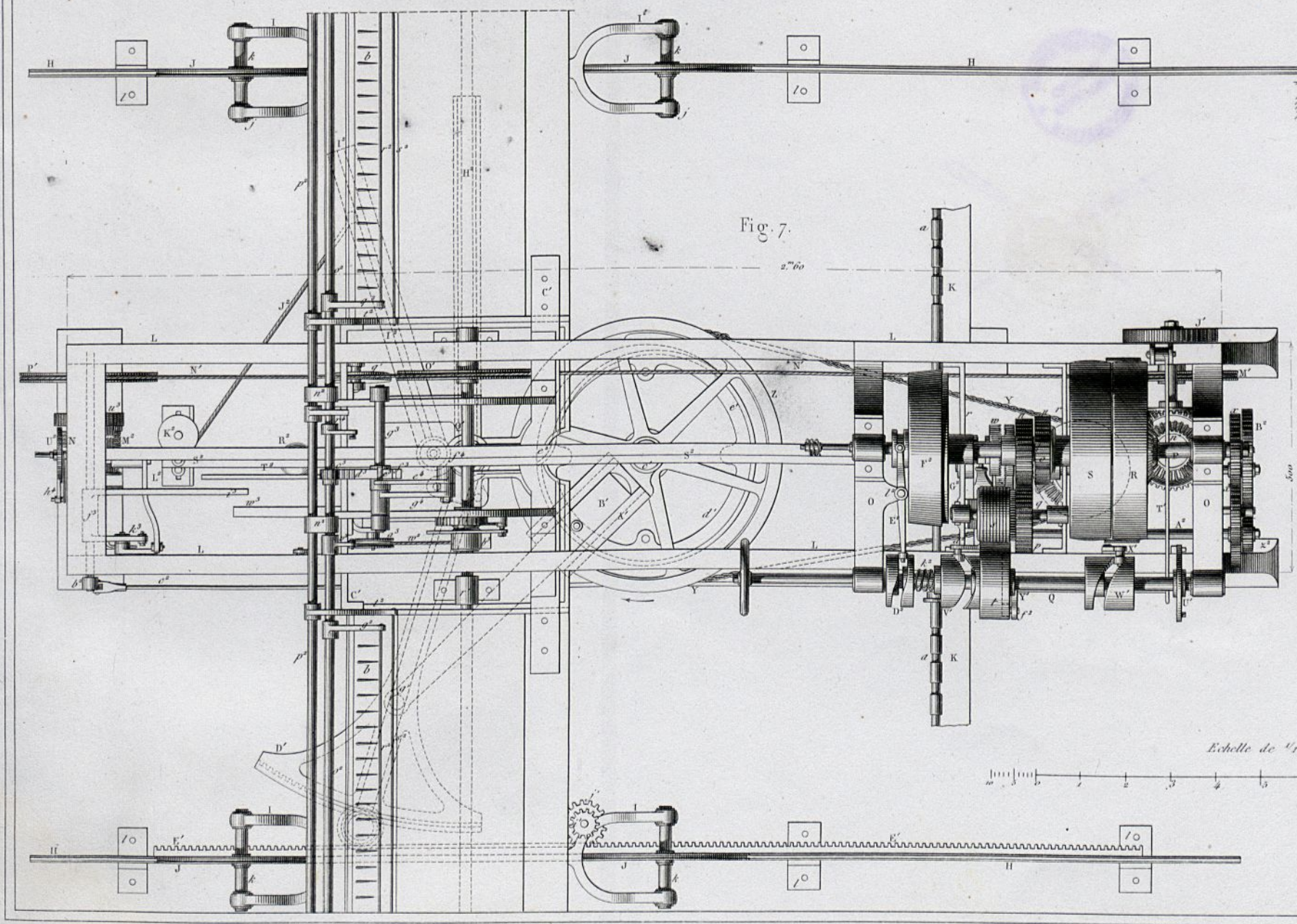
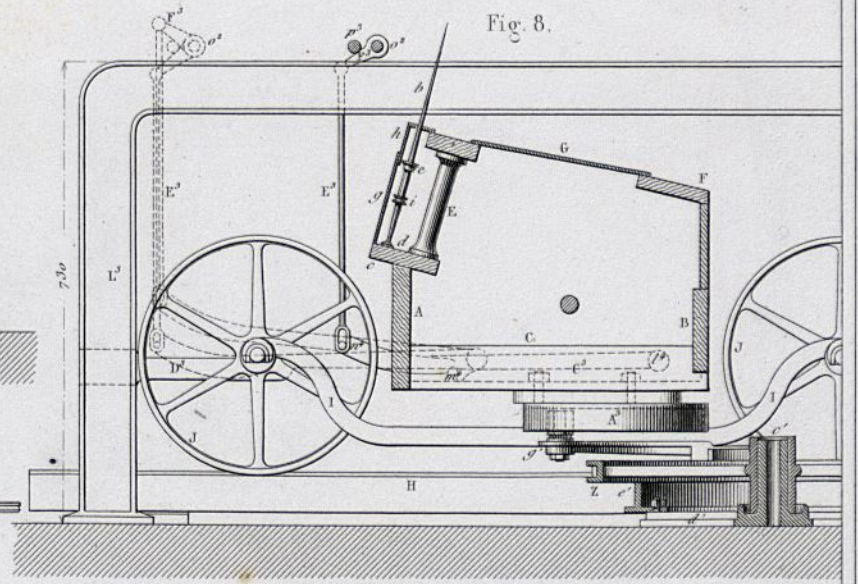
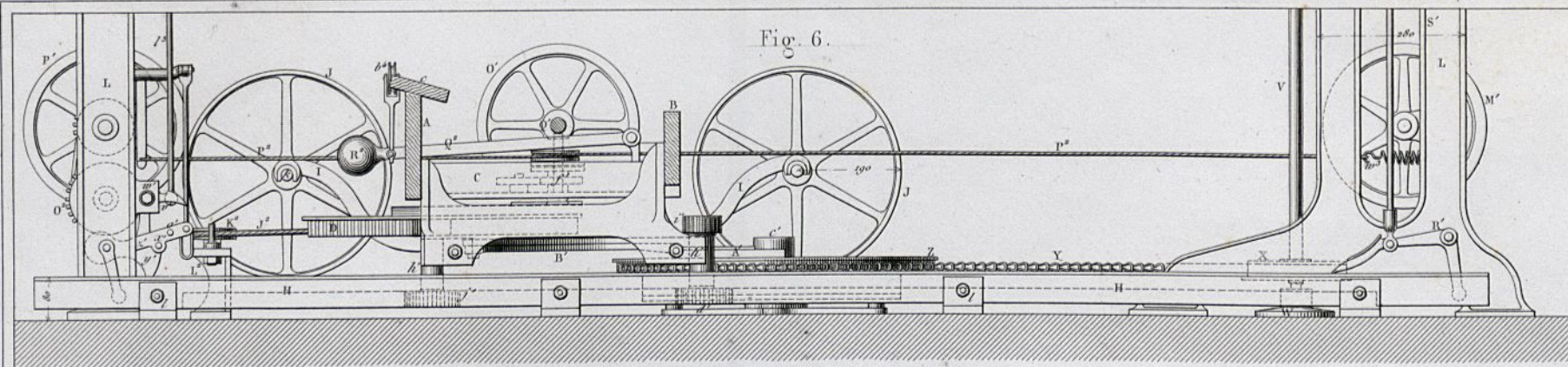

Echelle de 1/2<sup>e</sup>.  
 0 1 2 3 4 5 6 7 8 9 10 cent.



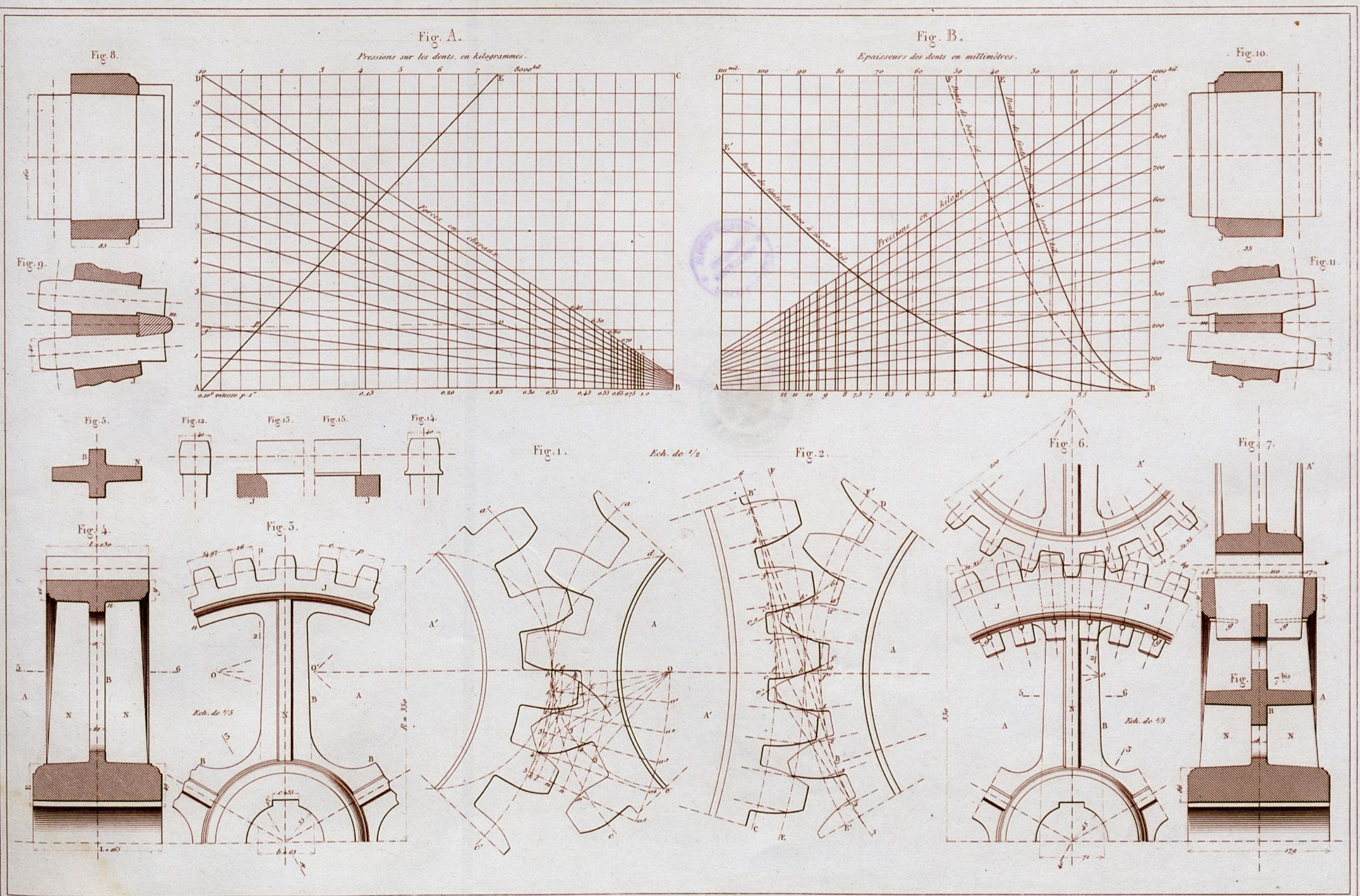









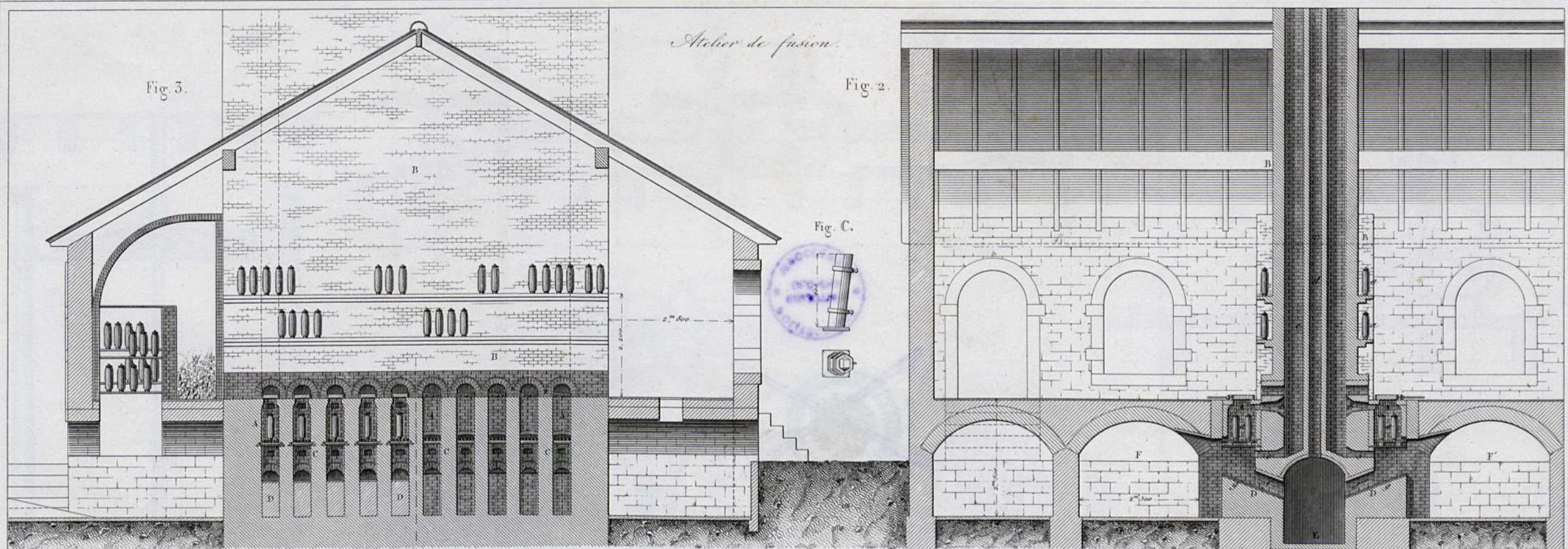

*Système perfectionné à doubles fonderies.*

*Ancien système.*

*Fours marchant à air comprimé.*

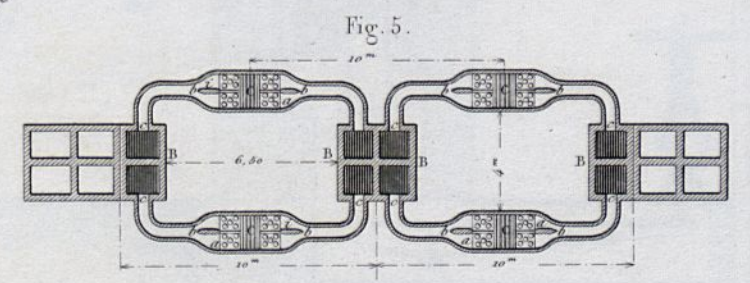
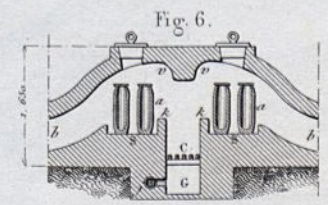
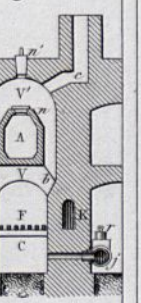
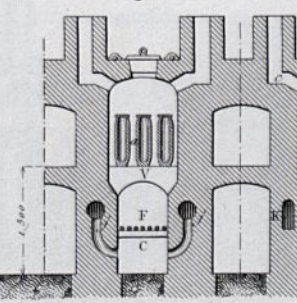
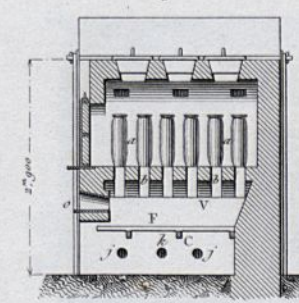
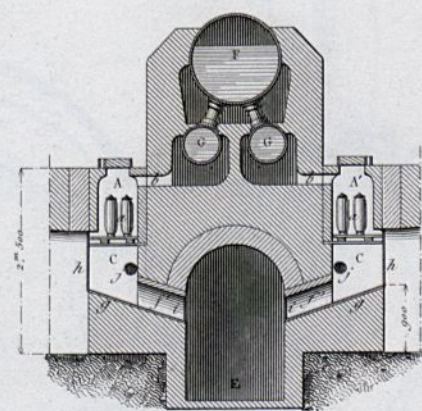
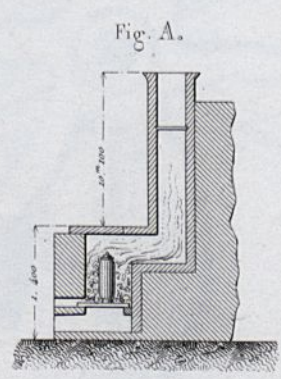
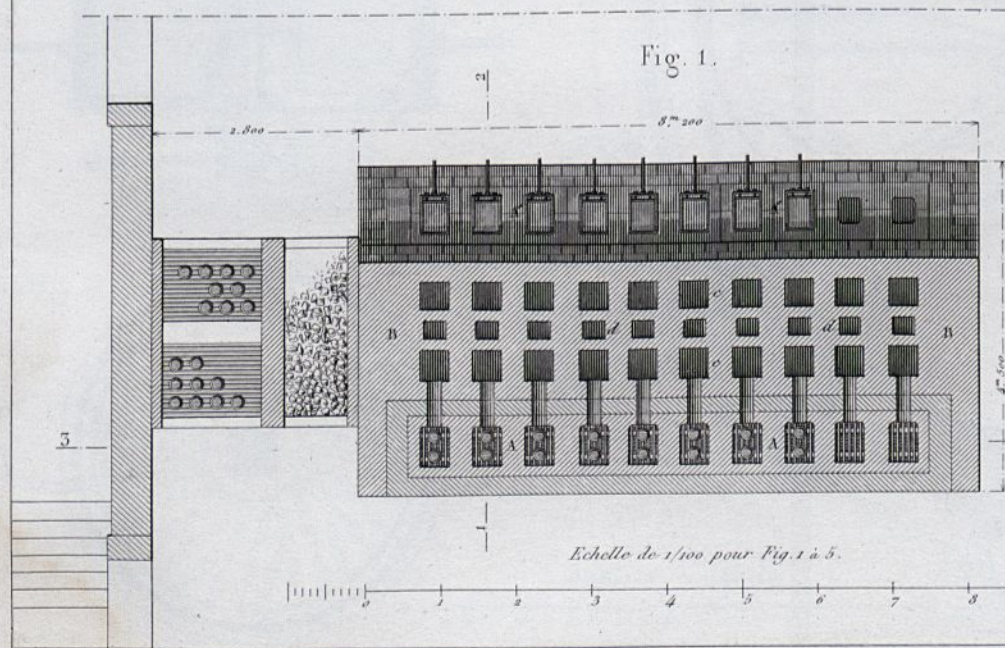



*Système de M. Darblay.*

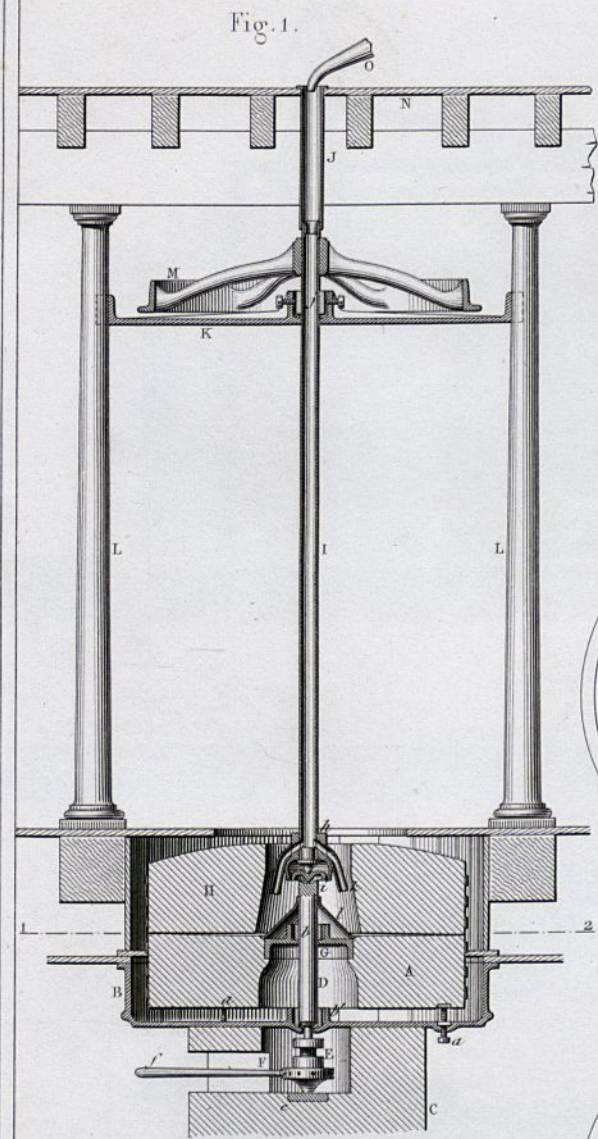

Fig. 2.

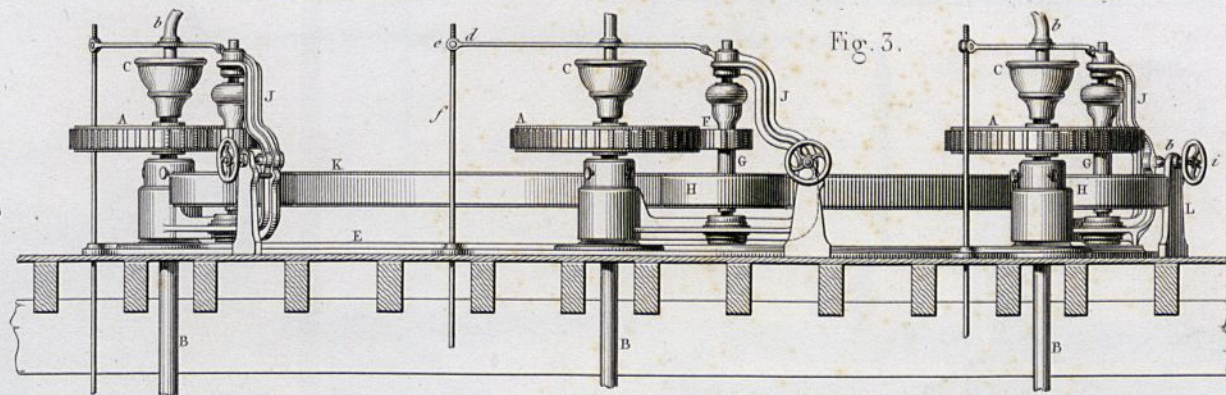
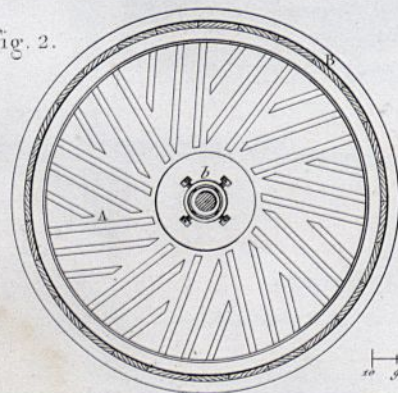
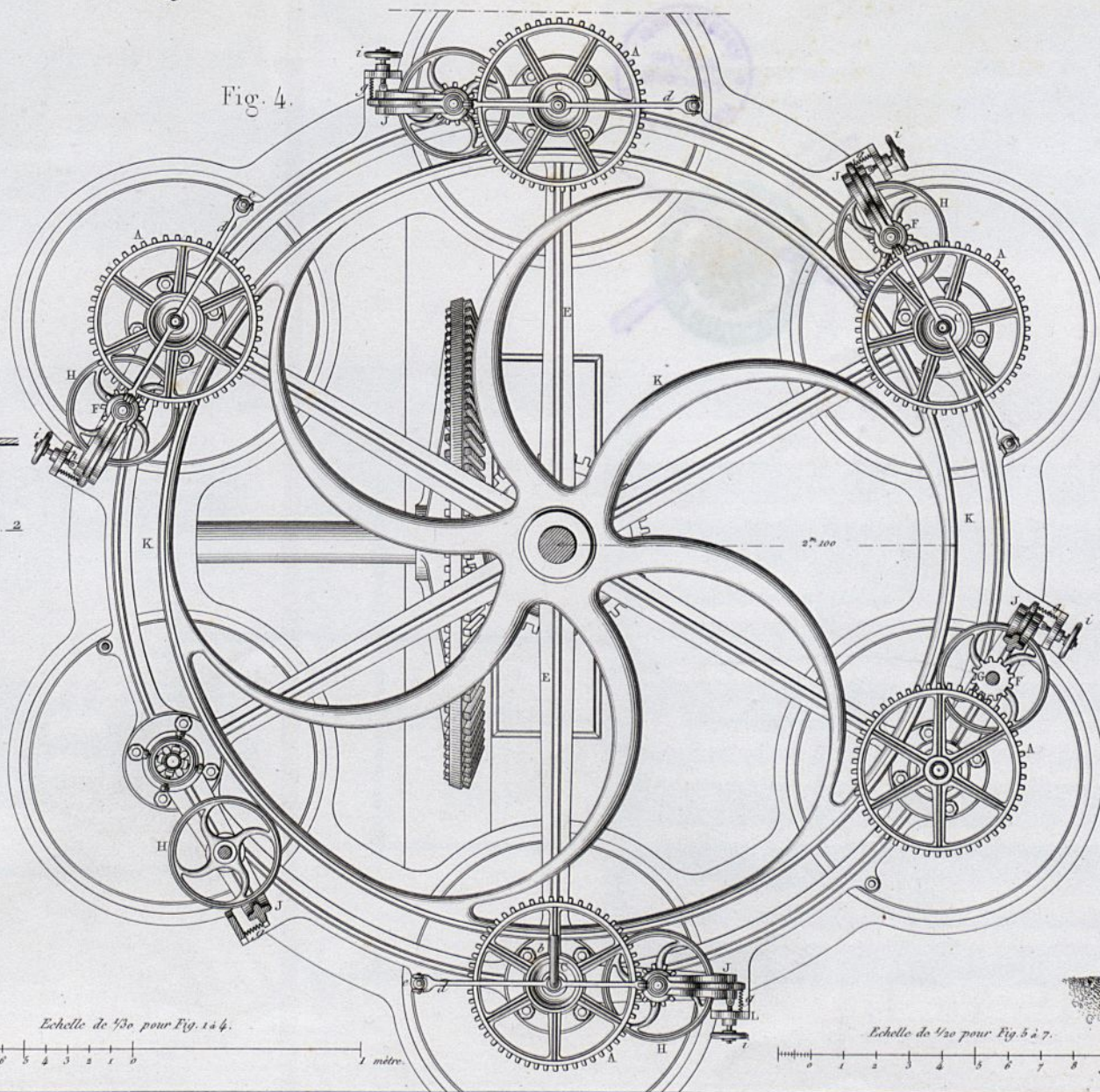
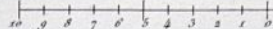

Fig. 3.

Fig. 4.



Echelle de 1/30 pour Fig. 1 & 4.



Echelle de 1/50 pour Fig. 5 à 7.

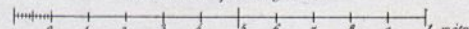

*Système à vitesse accélérée par M. M. Froment, Fontaine et Brault.*

Fig. 5.

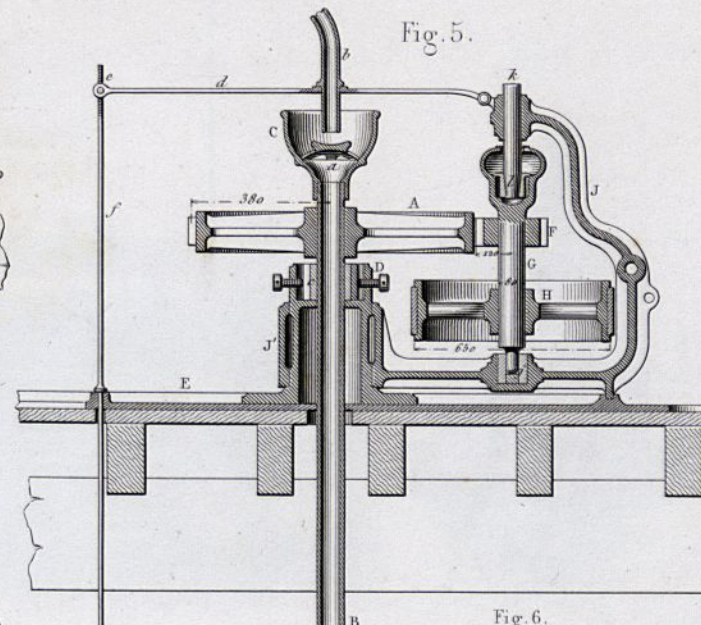
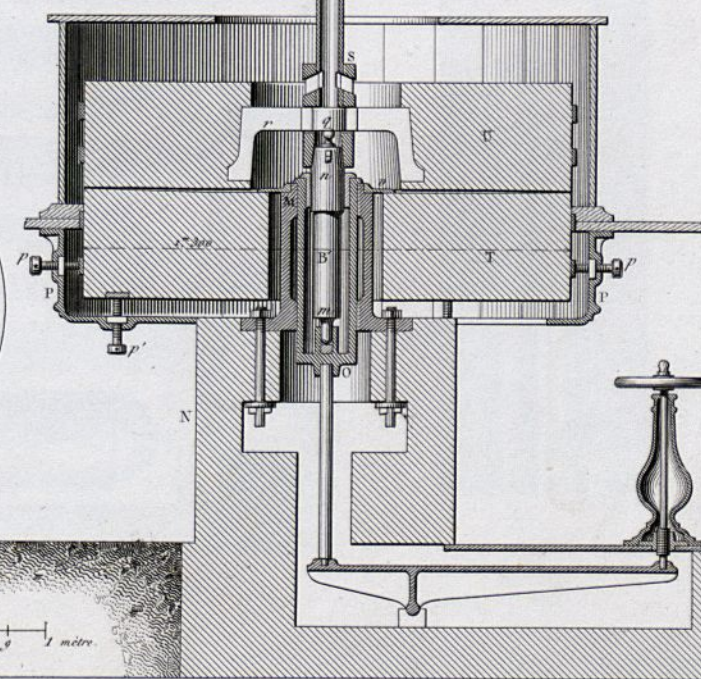

Fig. 6.



Fig. 7.





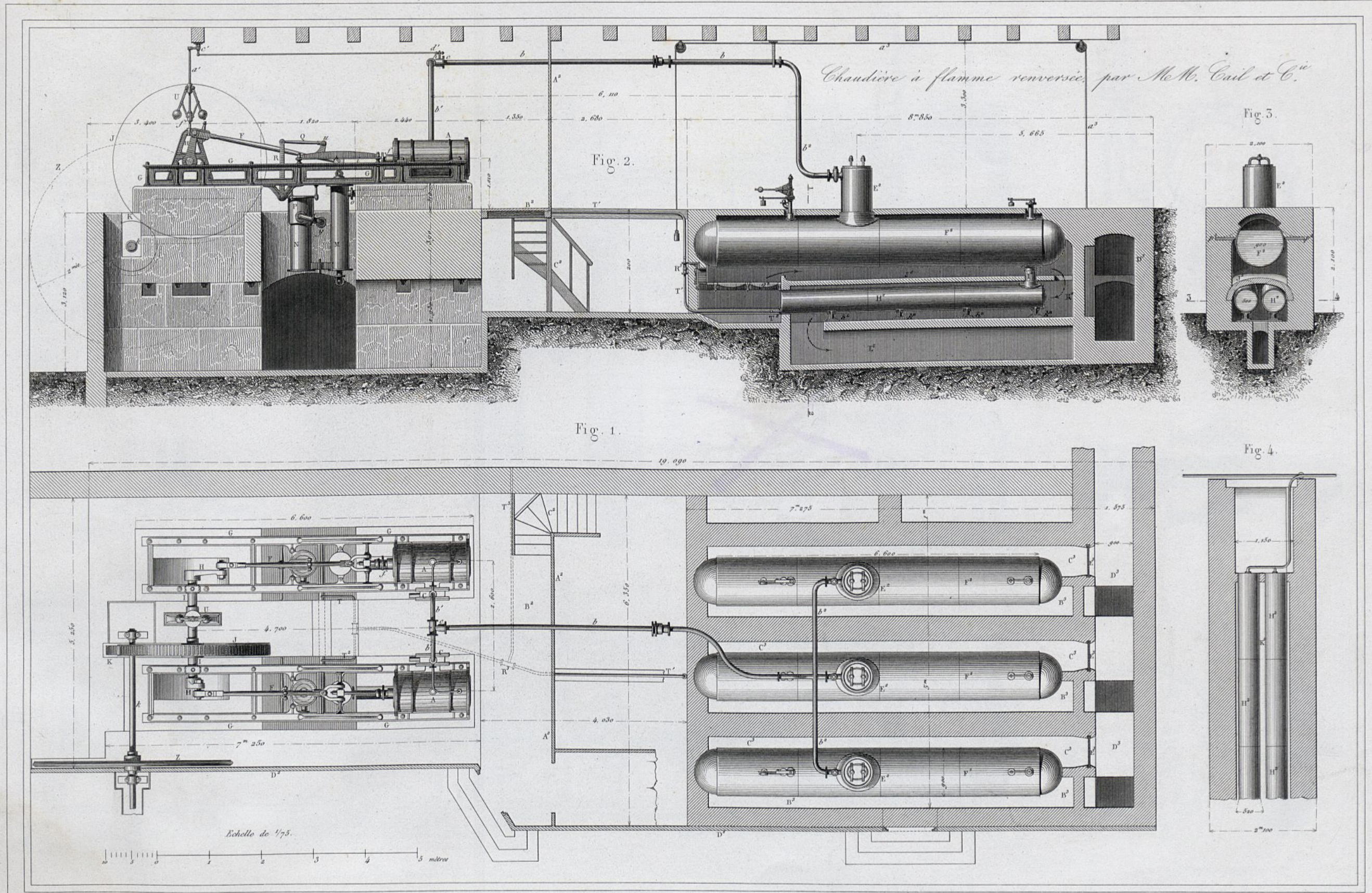

J. Petitcolin sculp.

Imp. de F. Chardon aîné r. Hautefeuille, 30. Paris

Armengaud aîné.





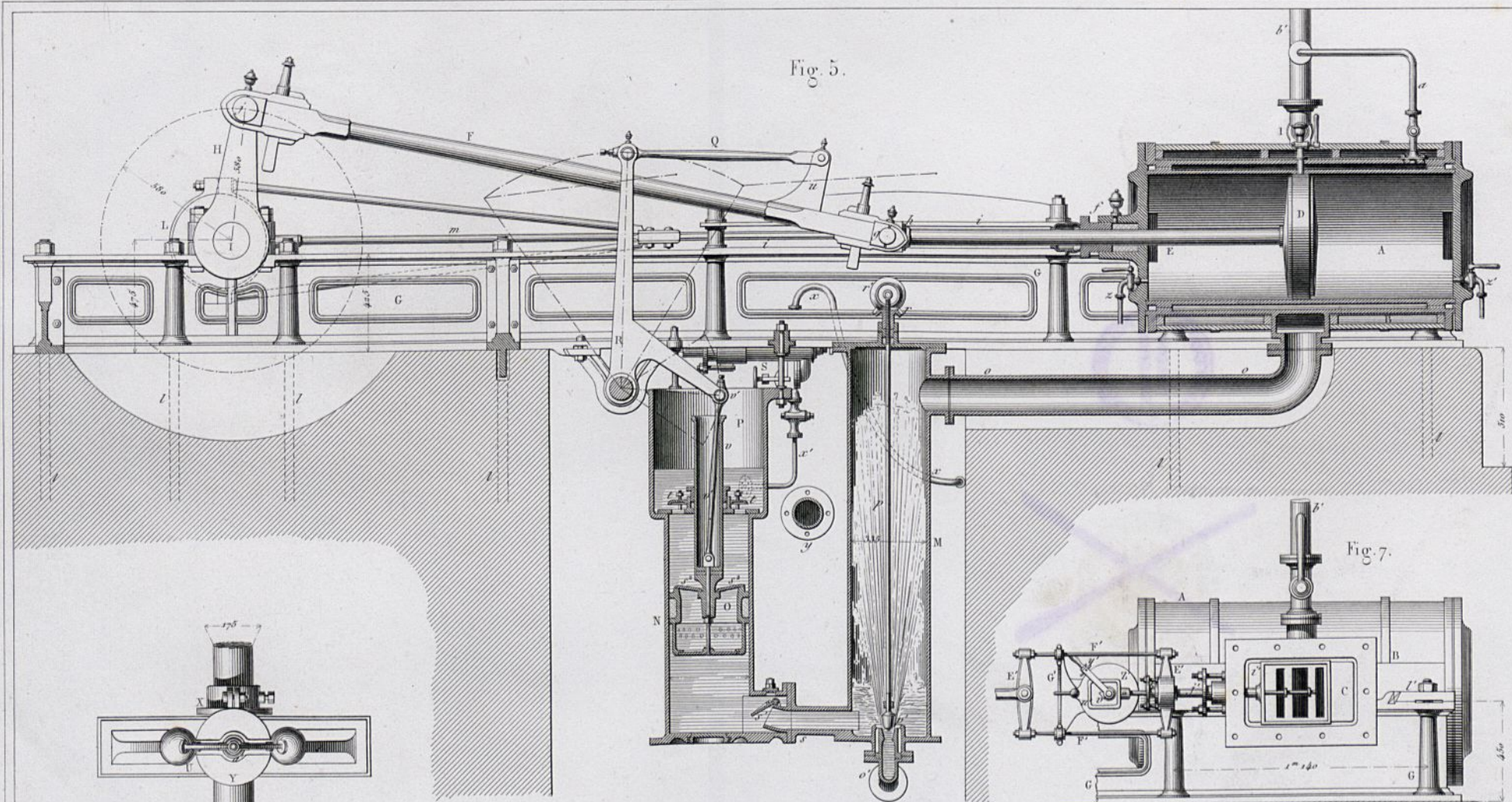

Fig. 5.

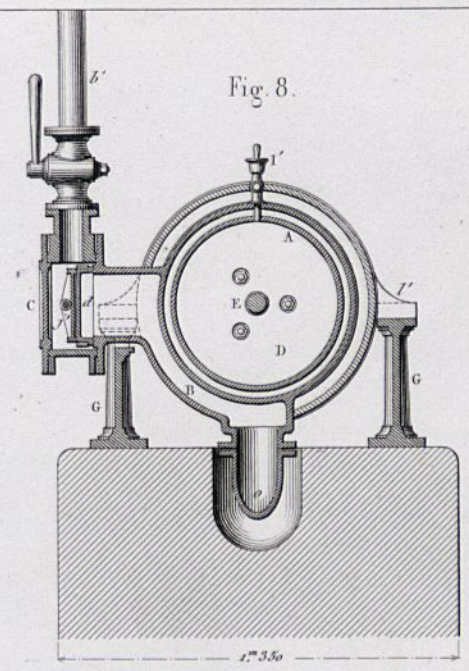

Fig. 8.

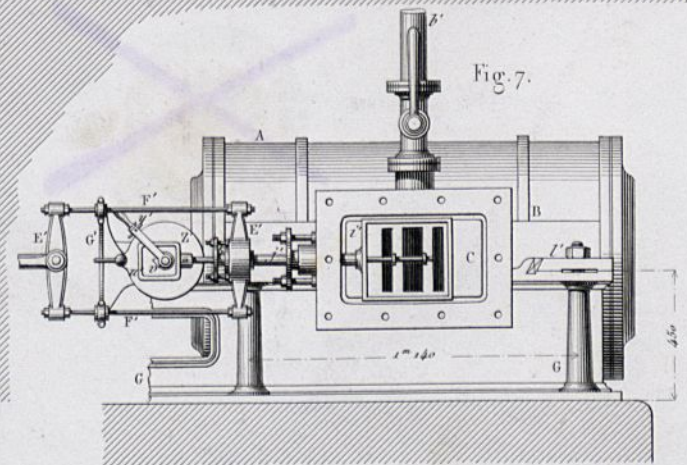

Fig. 7.

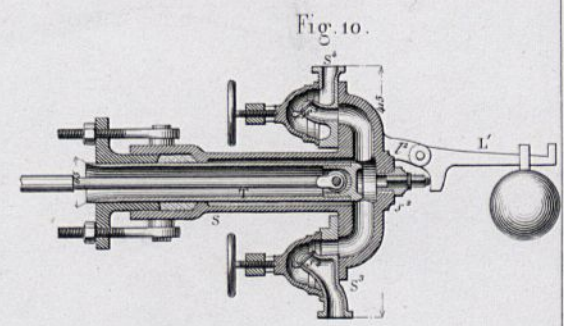

Fig. 10.

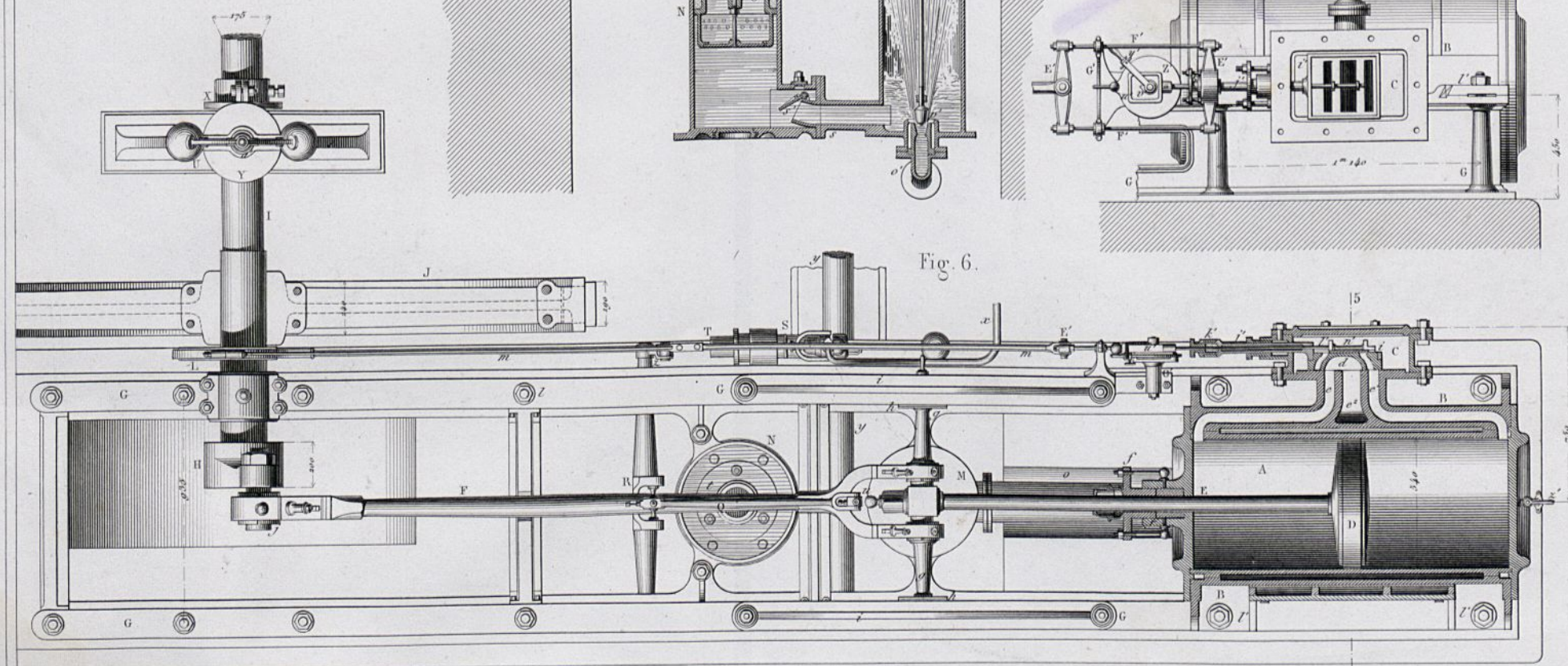

Fig. 6.

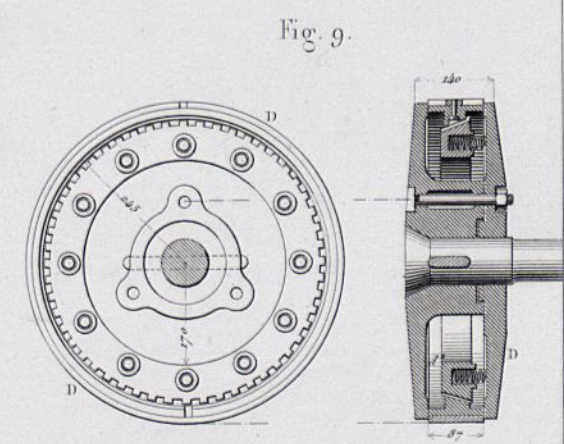

Fig. 9.

Echelle de 1/25 pour Fig. 5 & 6. 3 mètres.

Echelle de 2/25 pour Fig. 9 & 10.



*Métier continu à filer le coton.*

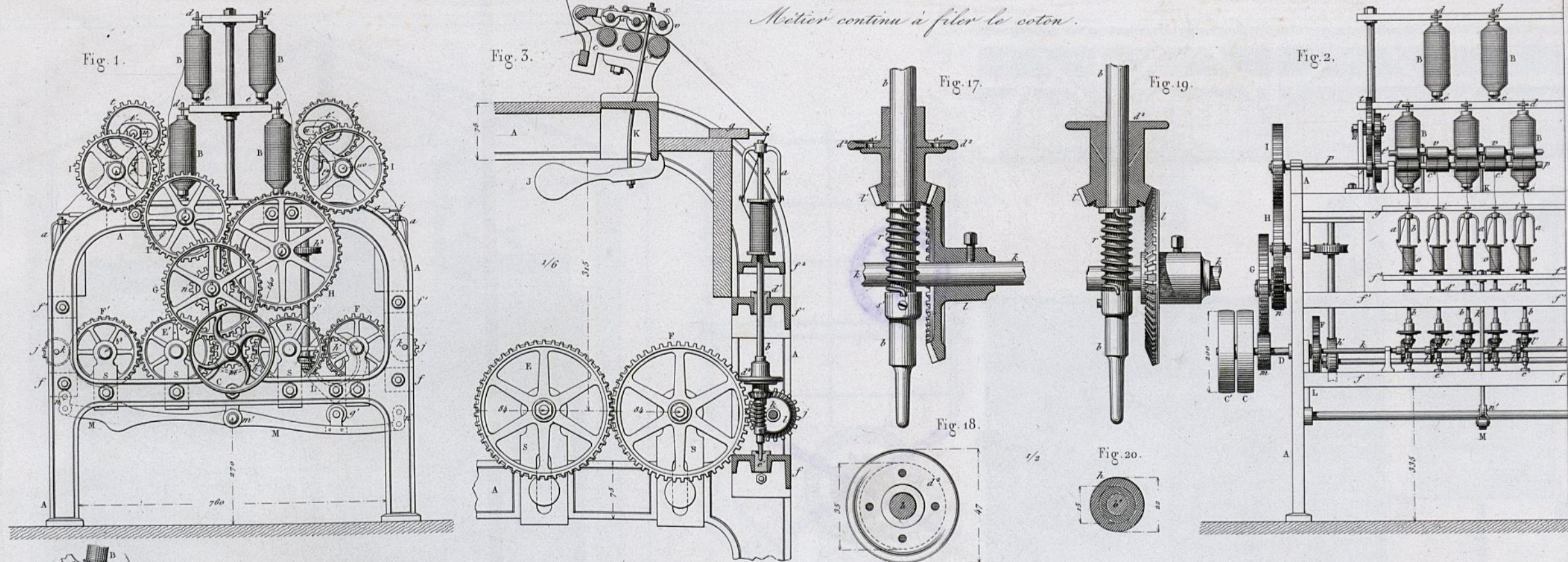

*Métier Mull-Jenny.*

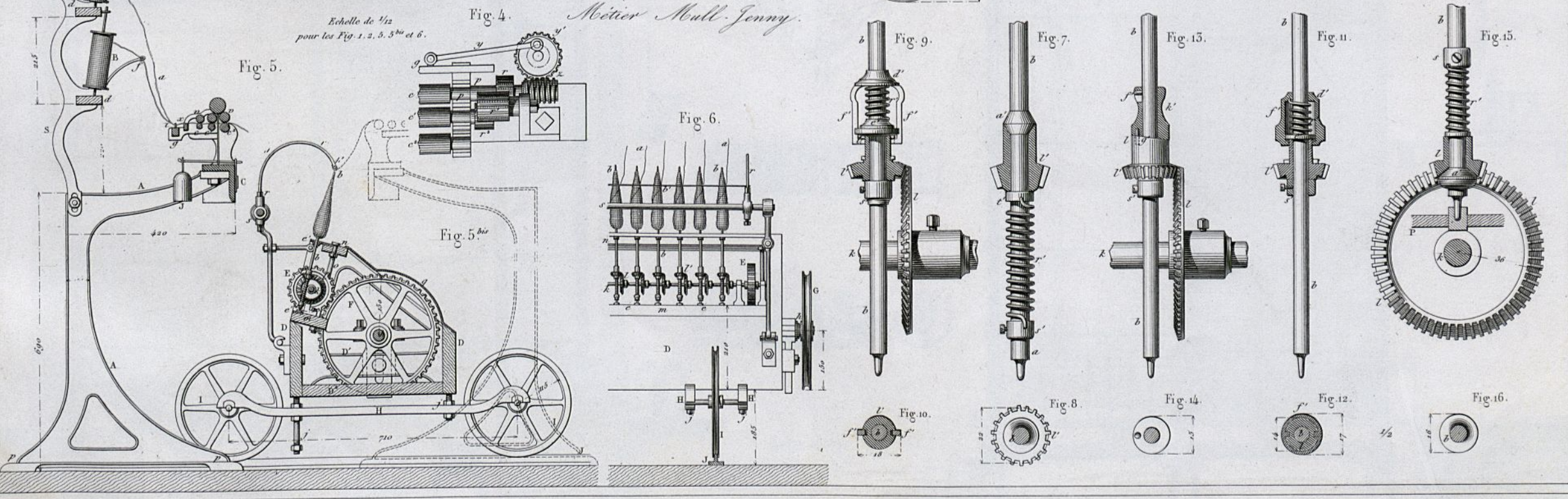



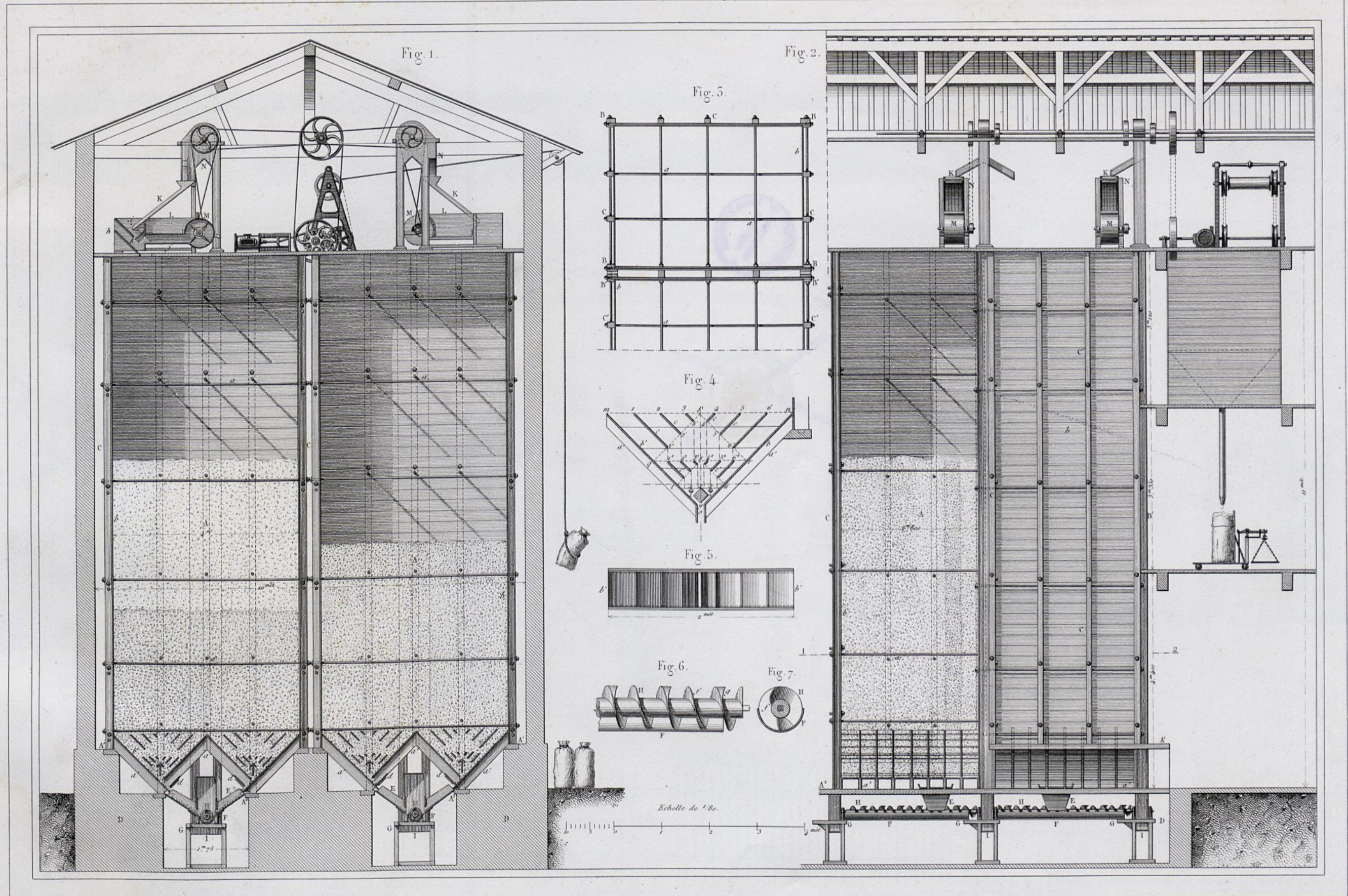



Fig. 1.

Longueur totale = 384<sup>m</sup> 45

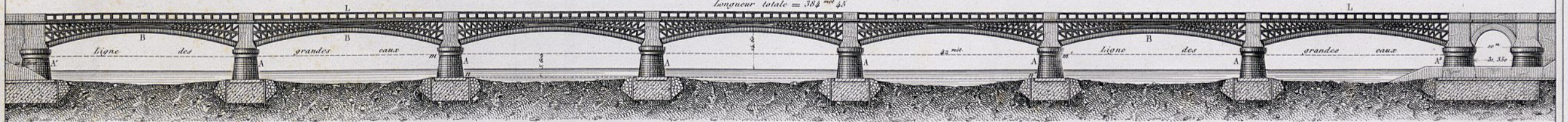

Fig. 5.

Fig. 2.

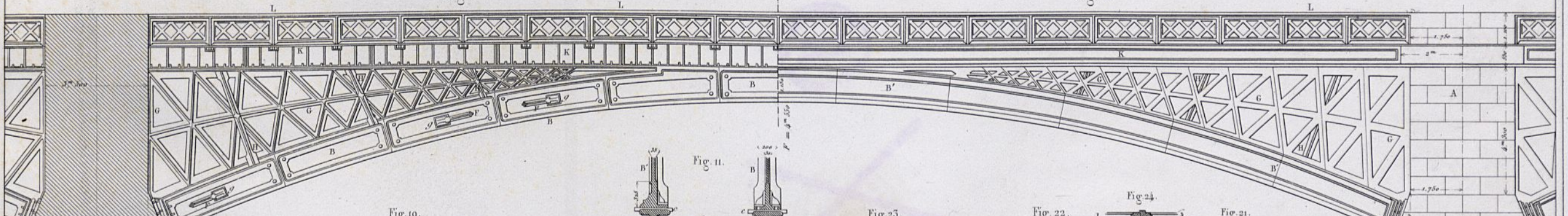

Fig. 11.

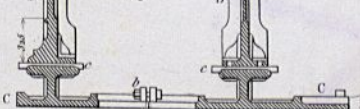

Fig. 12.

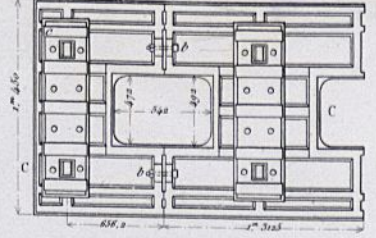

Fig. 19.

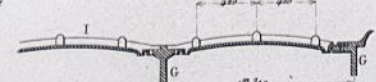

Fig. 20.

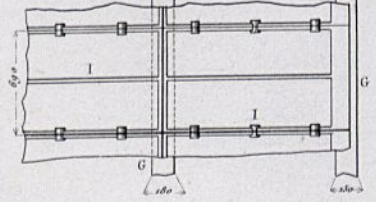

Fig. 18.



Fig. 23.



Fig. 22.

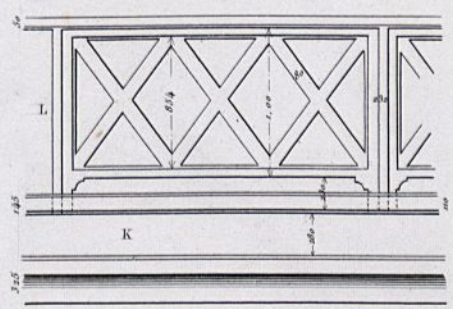

Fig. 24.



Fig. 21.



Inclinaison 1<sup>m</sup> par mètre  
Niveau des plus hautes eaux  
Rayon = 50<sup>m</sup> 240

Fig. 14.

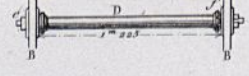

Fig. 16.

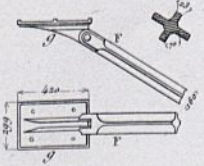

Fig. 15.

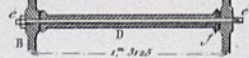

Fig. 17.

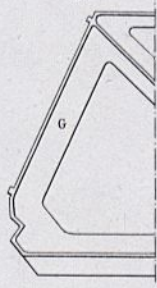

Fig. 13.

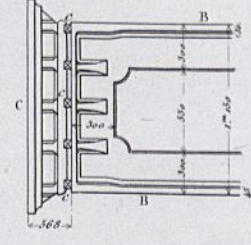

Fig. 9.

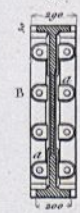

Fig. 8.

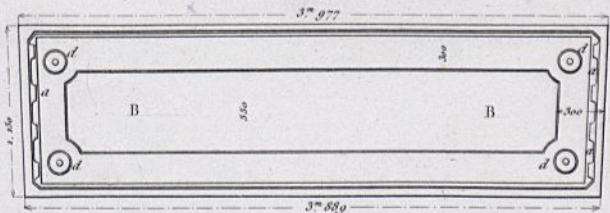

Fig. 10.

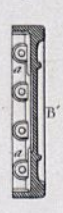

Fig. 7.

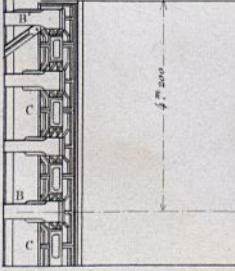

Fig. 6.

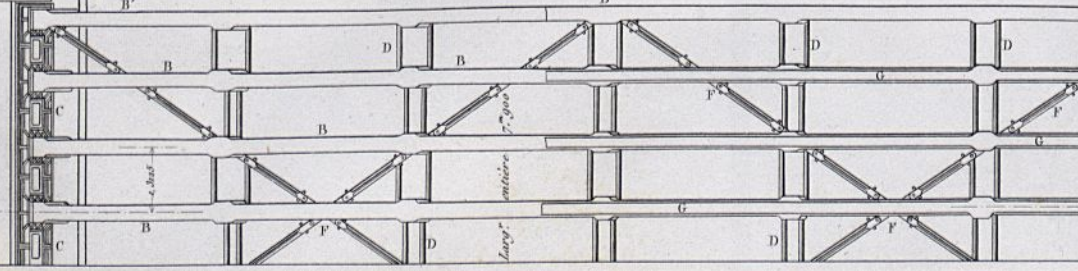

Fig. 5.

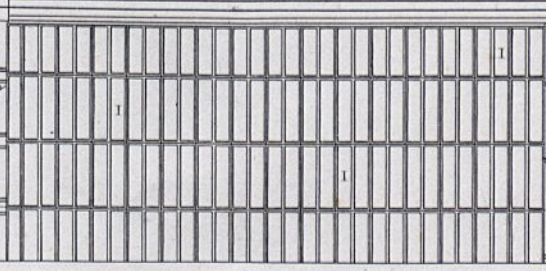
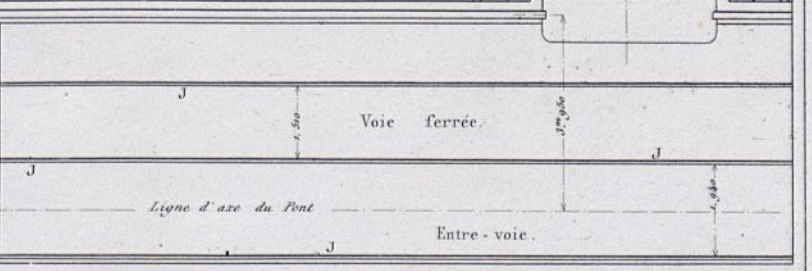

Fig. 4.



Voie ferrée

Ligne d'axe du Pont

Entre-voie





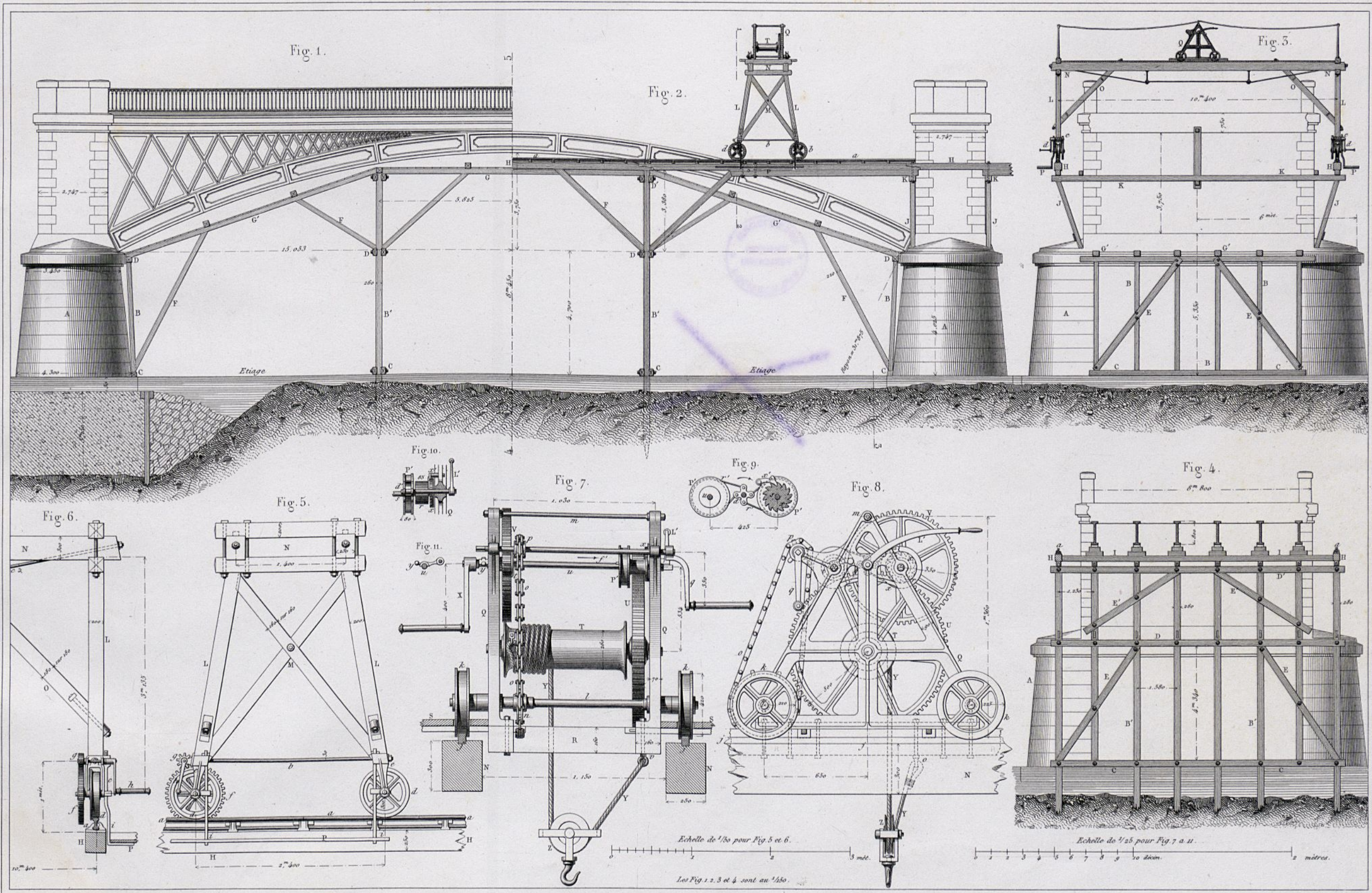



*Roigneuse mécanique de M. Poirier.*

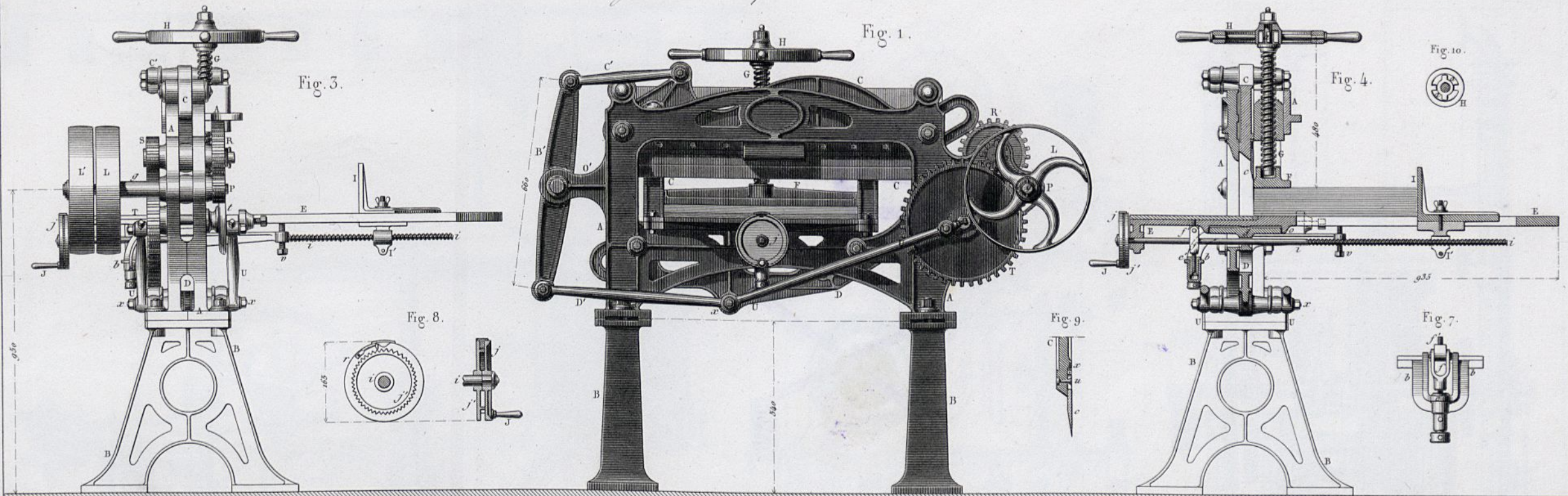

*Roigneuse circulaire de M. Pfeiffer.*

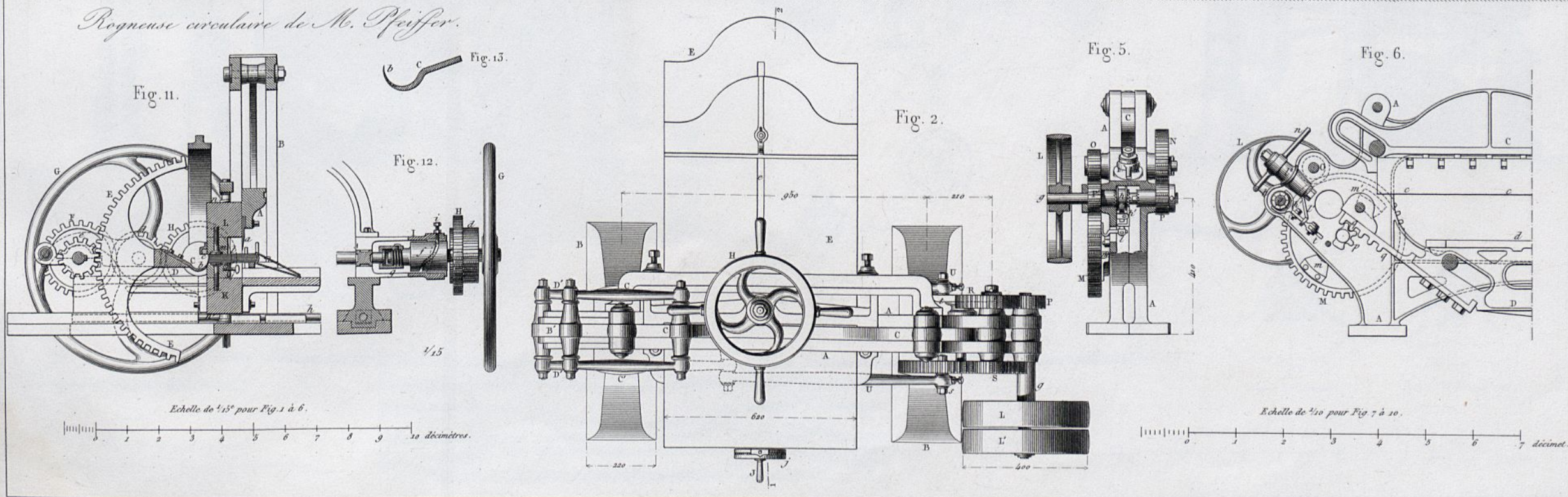

Echelle de 1/15<sup>e</sup> pour Fig. 1 à 6.

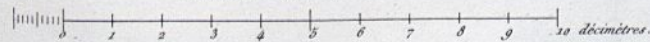

Echelle de 1/10<sup>e</sup> pour Fig. 7 à 10.

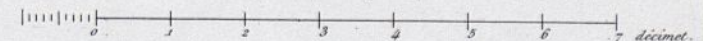



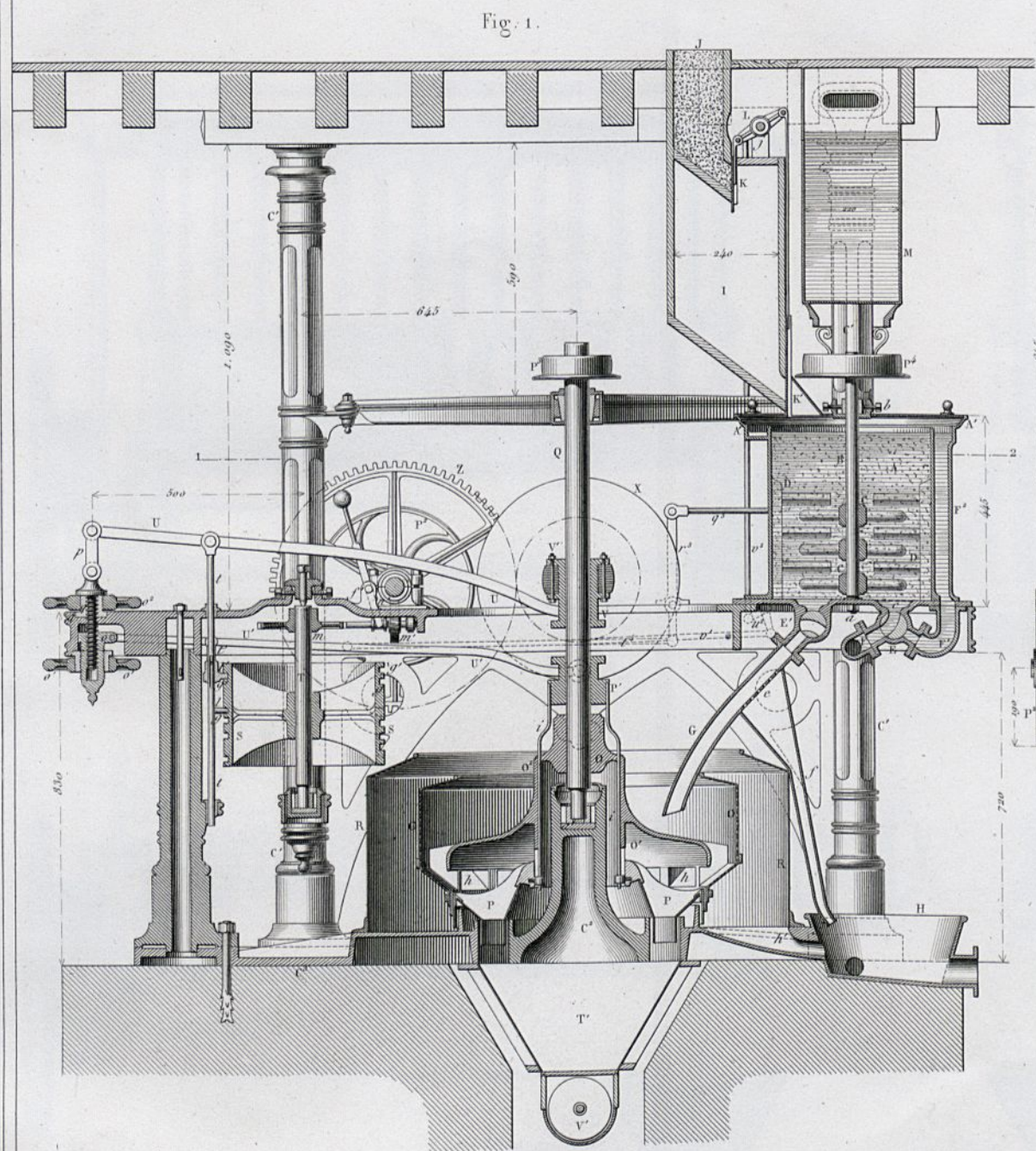

Fig. 1.

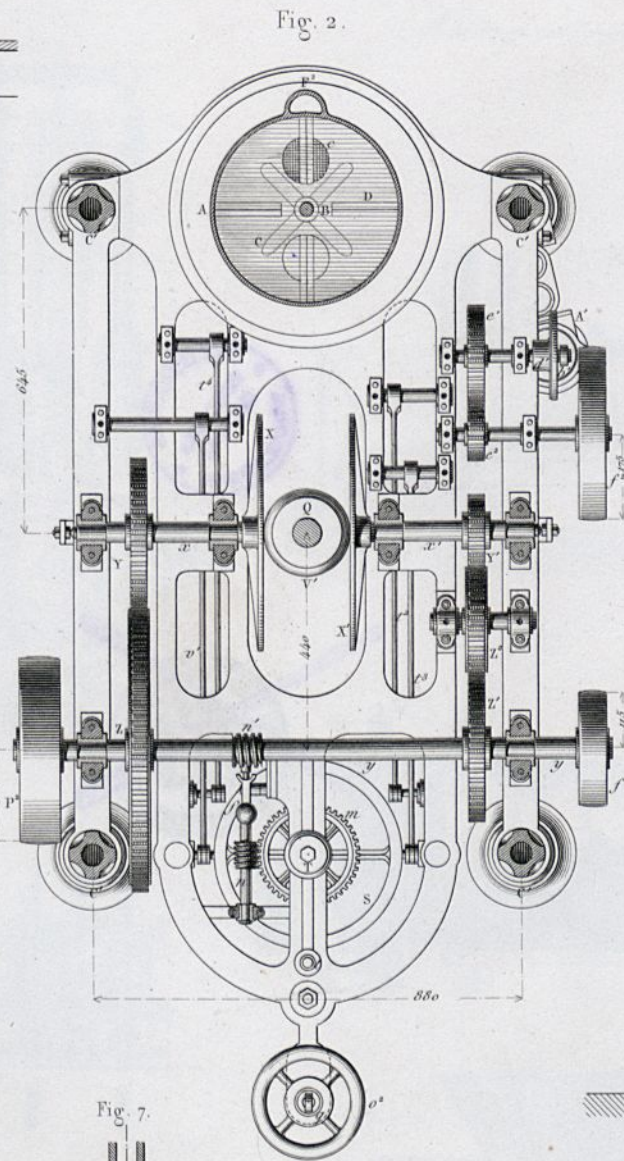

Fig. 2.

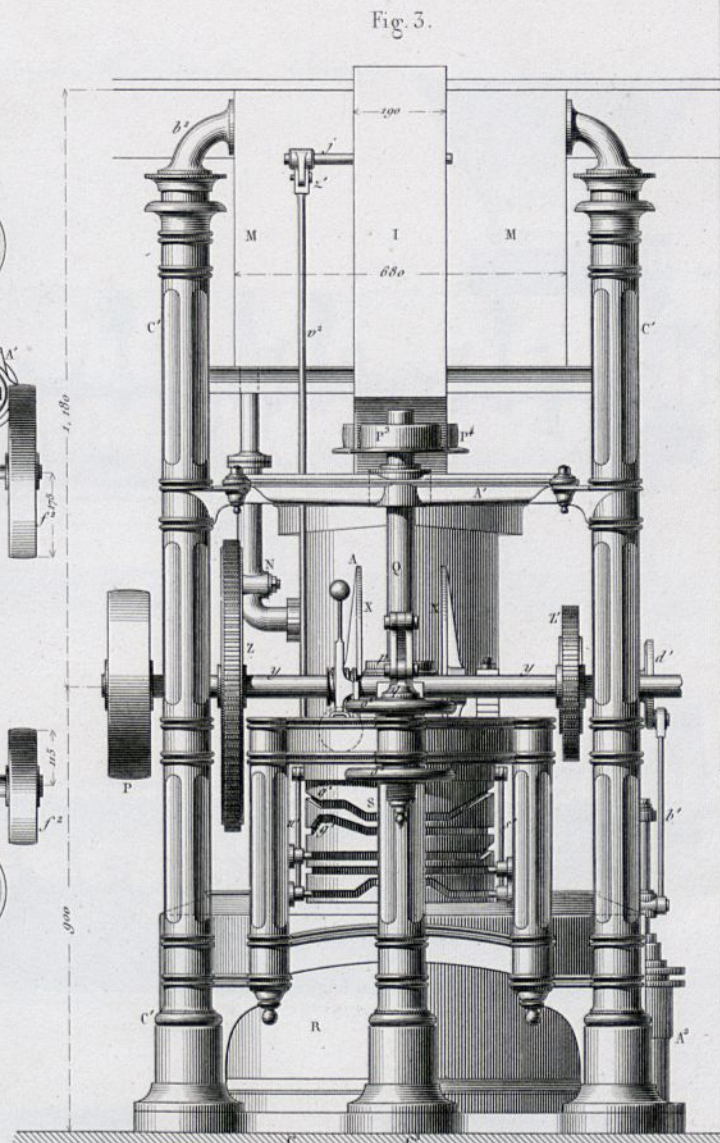

Fig. 3.

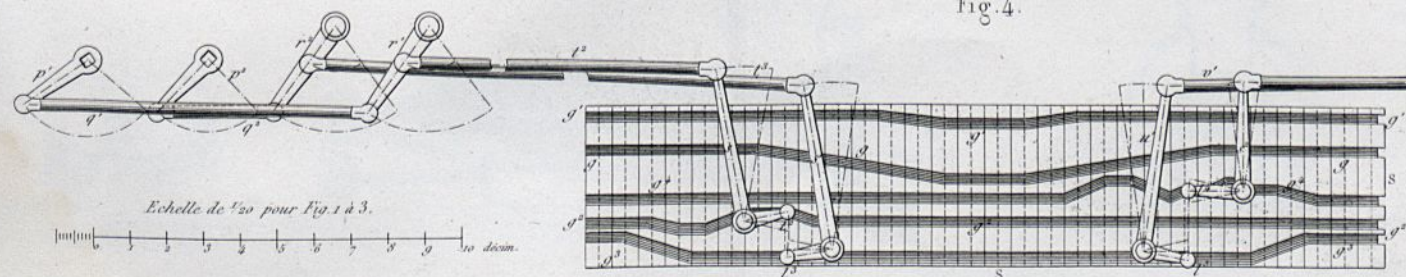

Fig. 4.

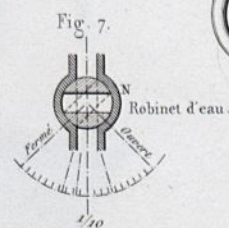

Fig. 7.

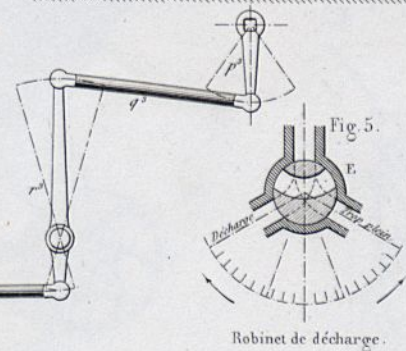

Fig. 5.

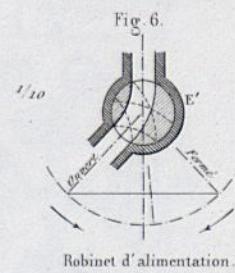
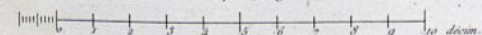

Fig. 6.

Echelle de 1/20 pour Fig 1 à 3.



Echelle de 1/5 pour Fig 4.

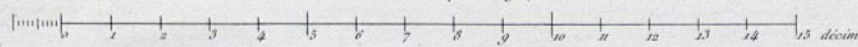



Fig. 5.

*Machine à mouler.*

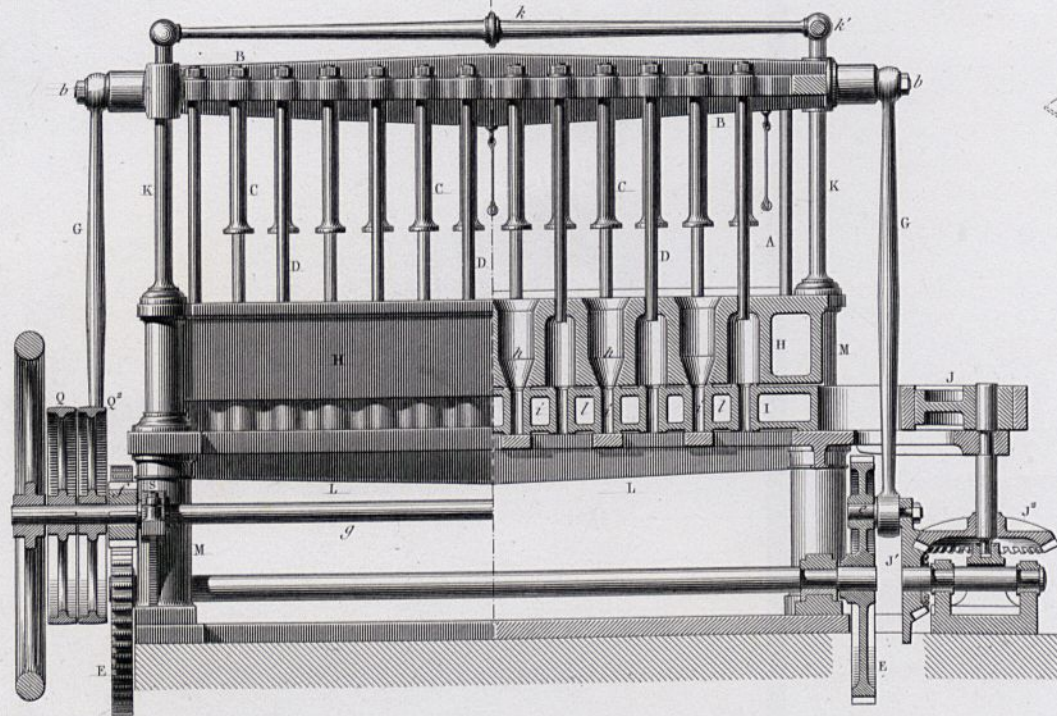
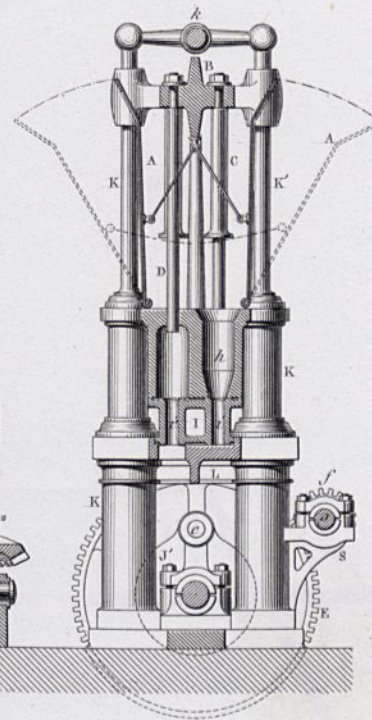

Fig. 6.



*Mélangeur par M. Popelin-Ducarre.*

Fig. 1.

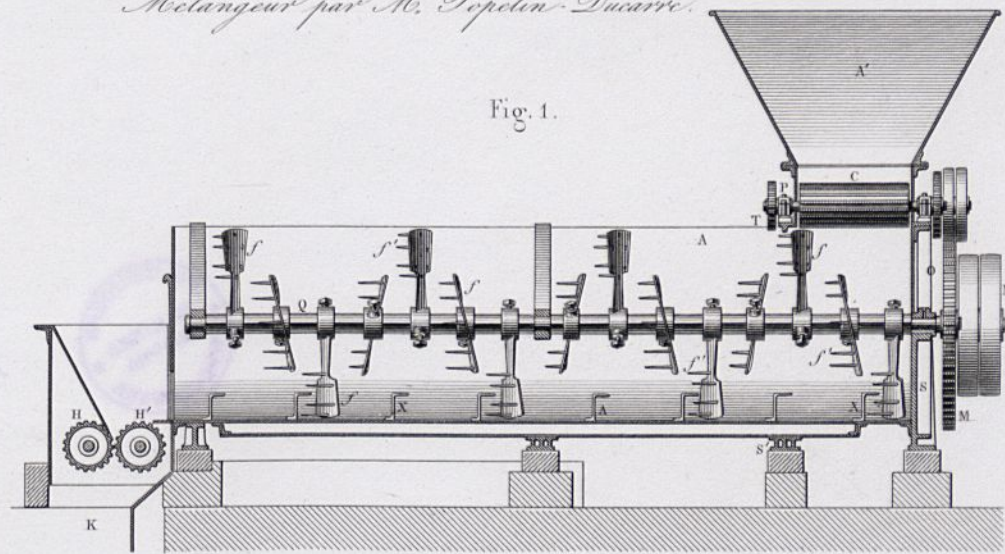

Fig. 4.

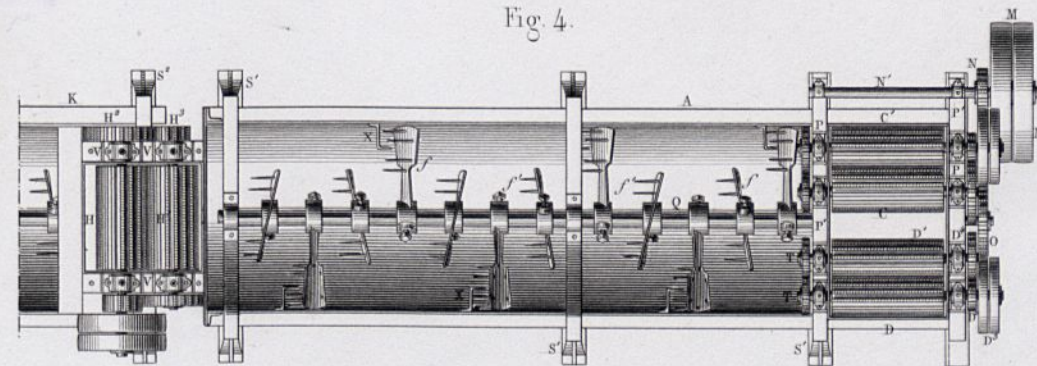

Fig. 7.

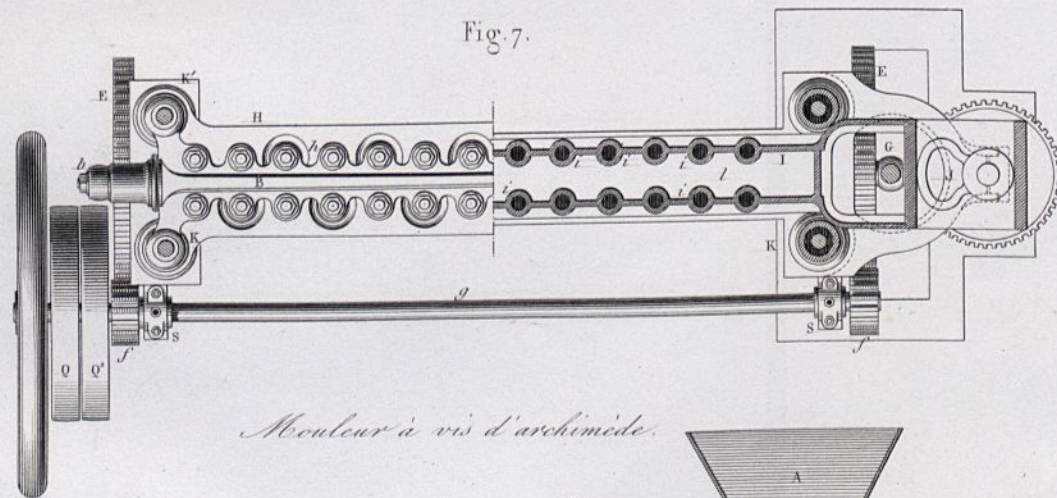
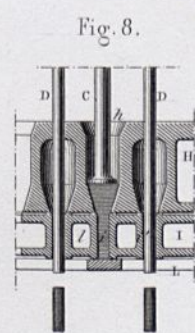

Fig. 8.



*Mouleur à vis d'archimède.*

Fig. 9.

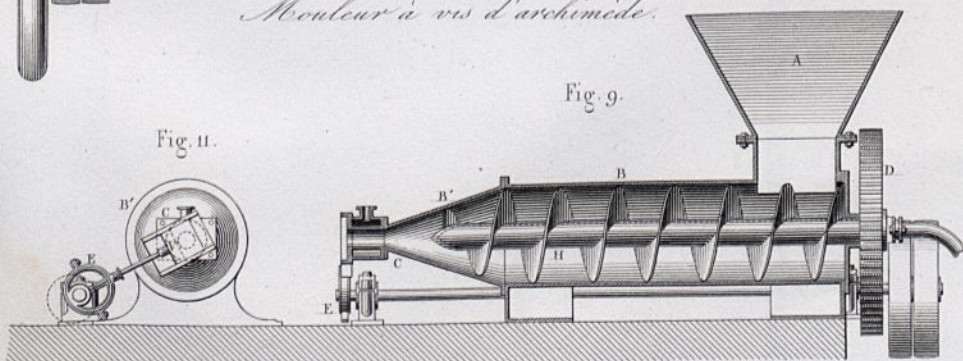
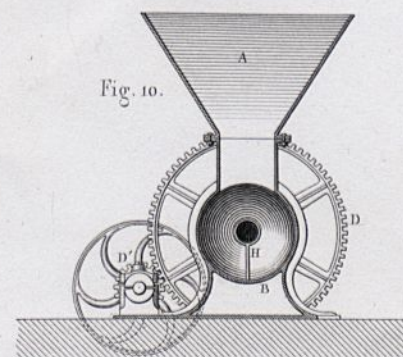

Fig. 10.



*Echelle de 1/20*

Fig. 2.

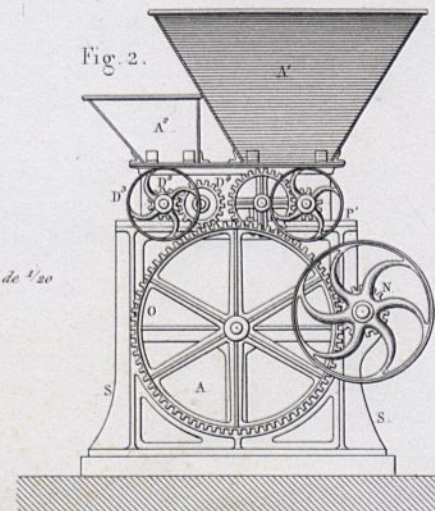
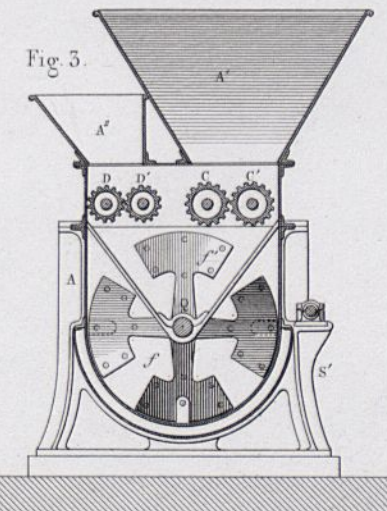

Fig. 3.







*Broyeurs et Mélangeurs.*  
*par M. Moreau.*

*Fours à carbonisation.*  
*par M. Popelin Ducarre.*

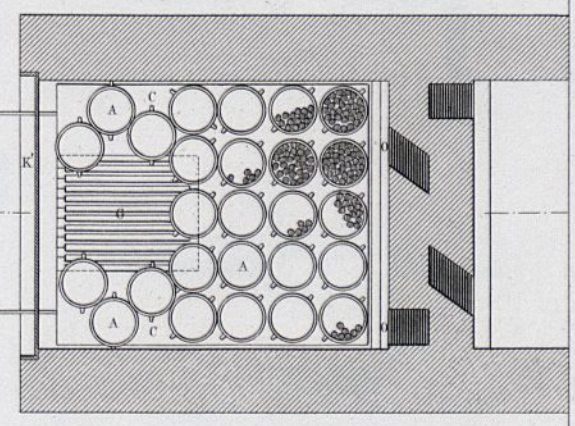
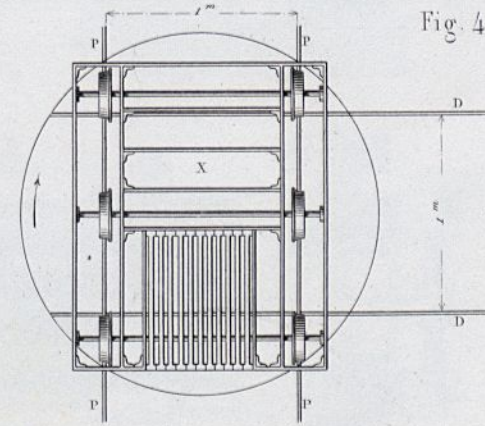
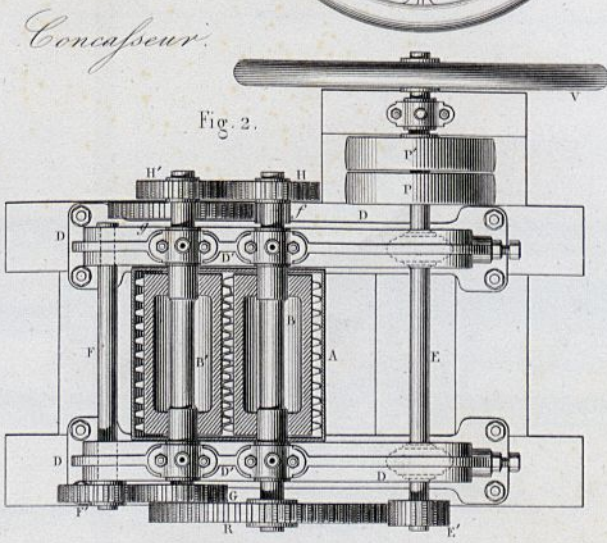
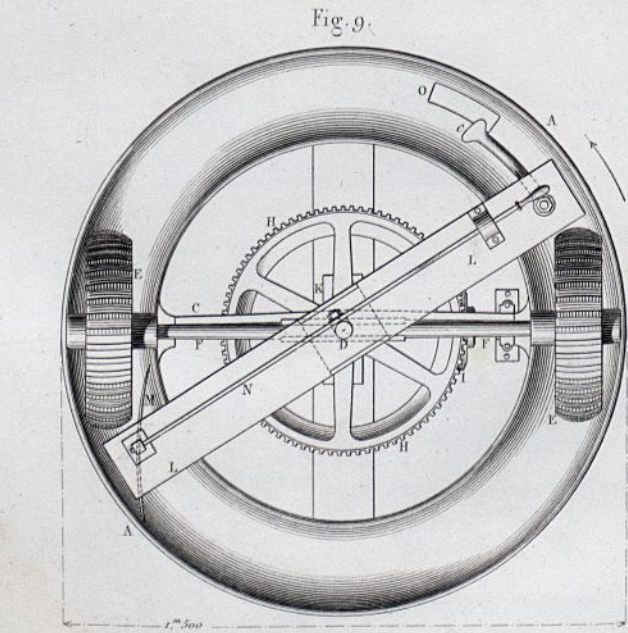
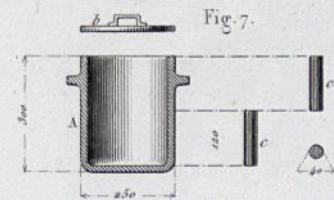
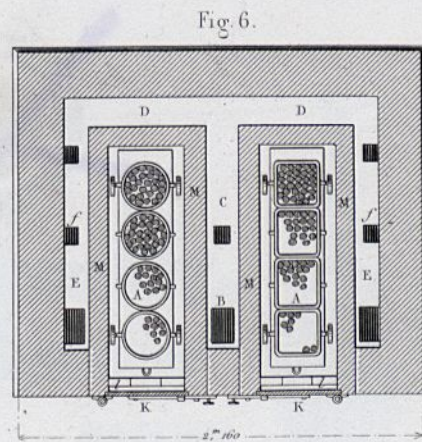
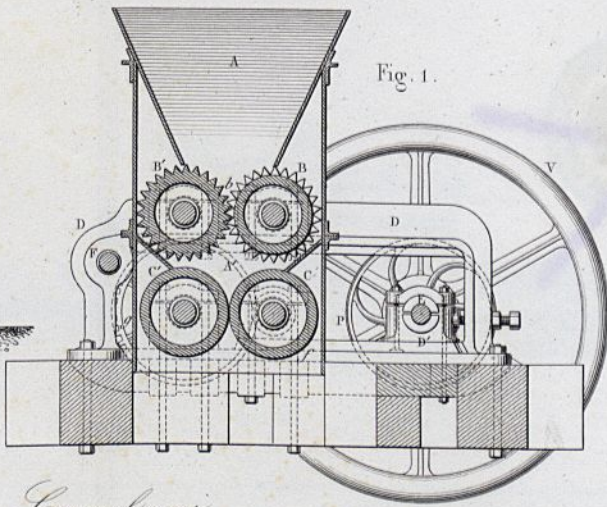
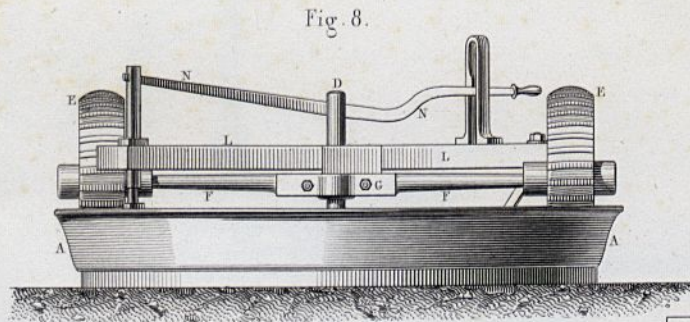
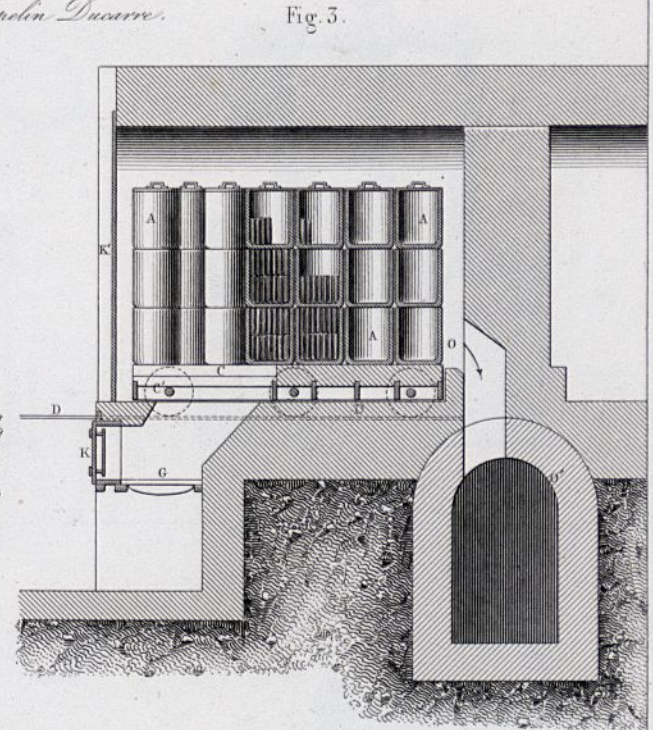
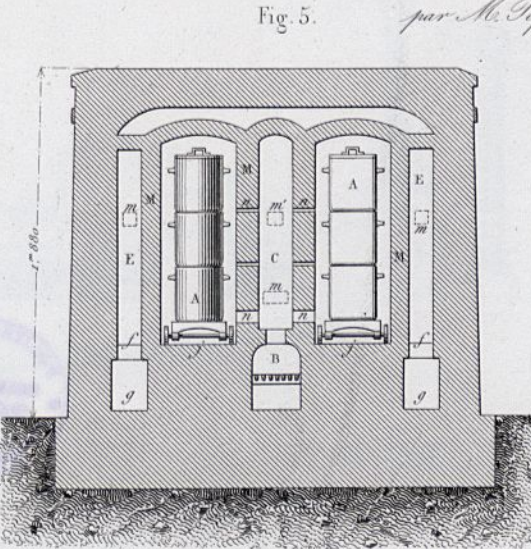
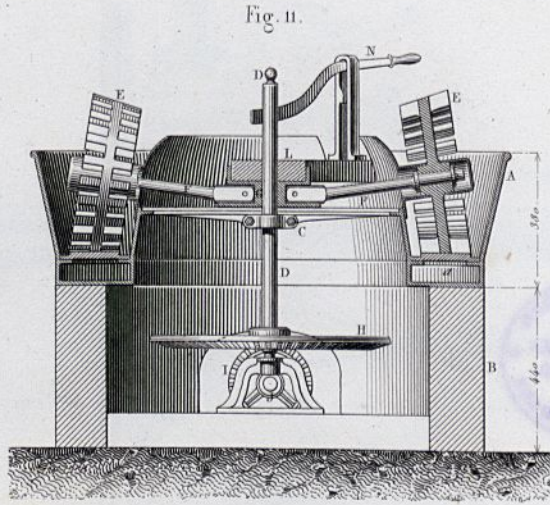
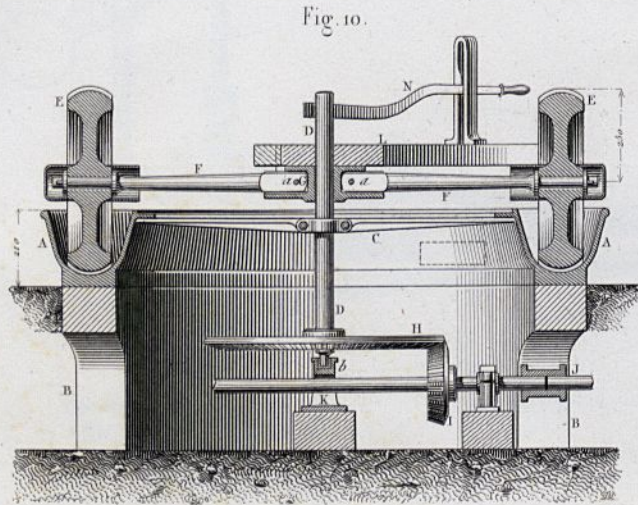

Echelle de 1/20 pour Fig. 1, 2 et 8 à 11.

Echelle de 1/30 pour Fig. 3 à 6.

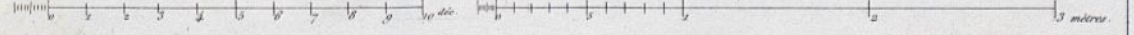



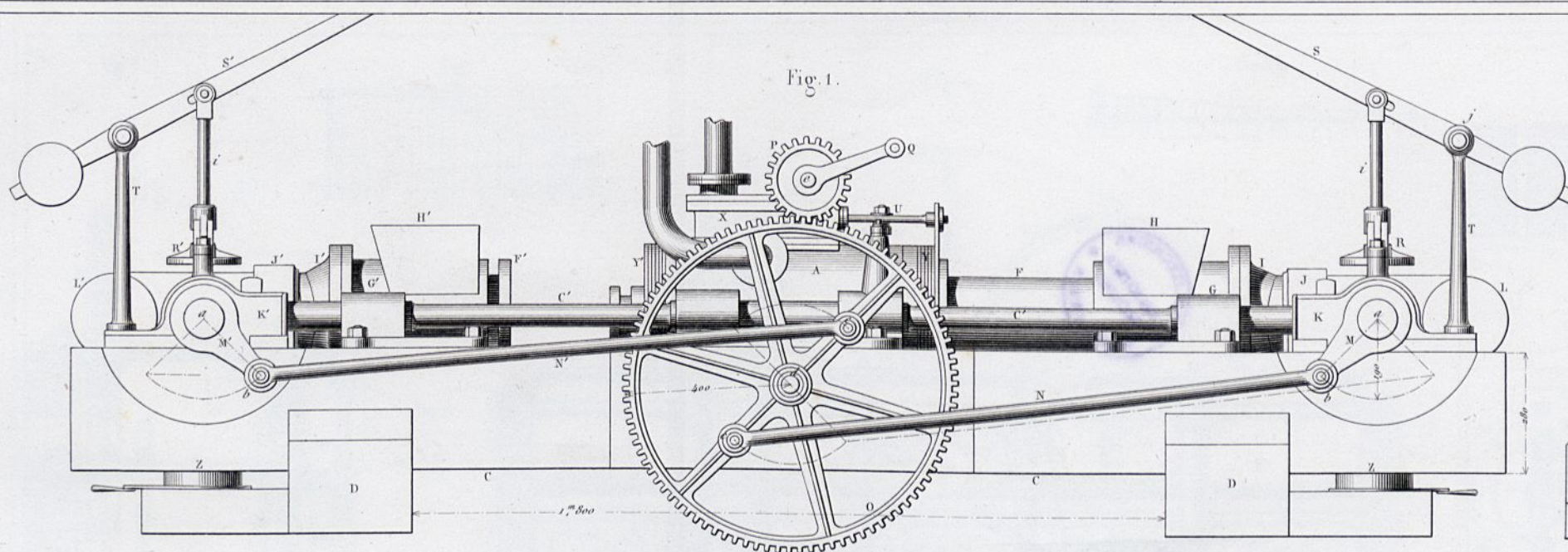

Fig. 1.

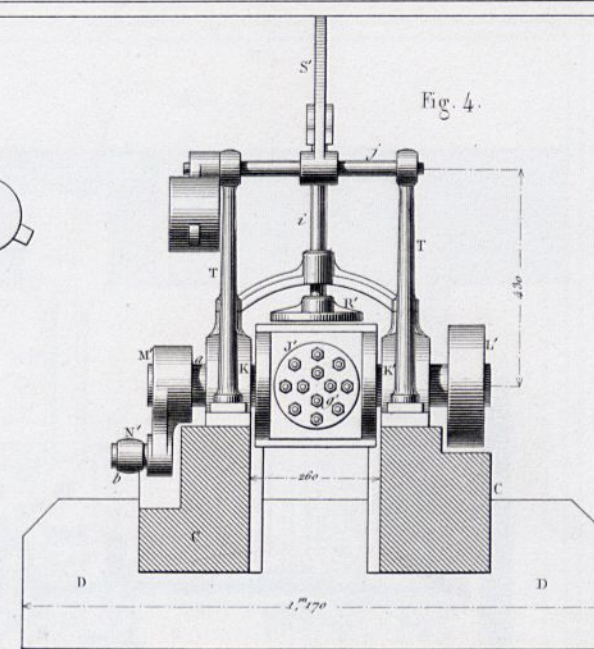

Fig. 4.

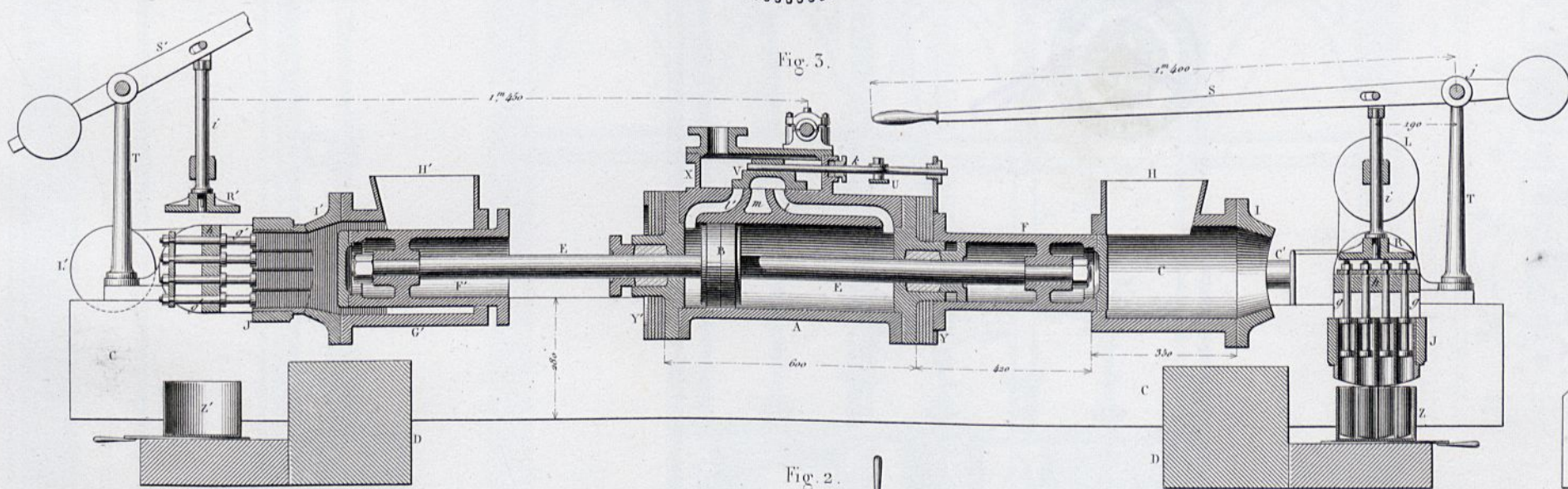

Fig. 5.

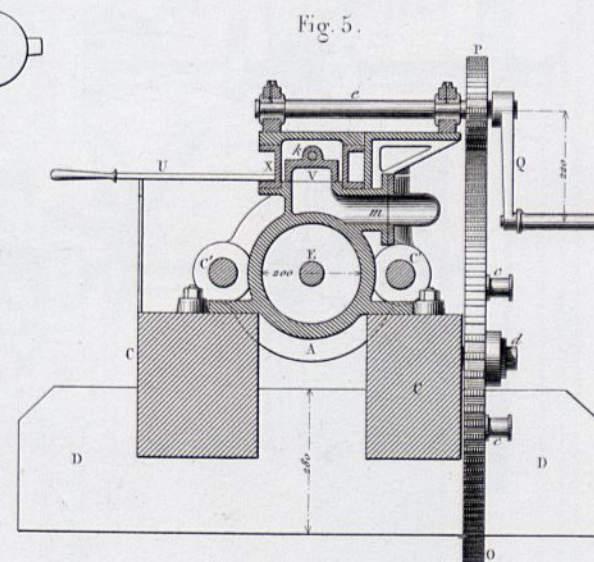

Fig. 5.

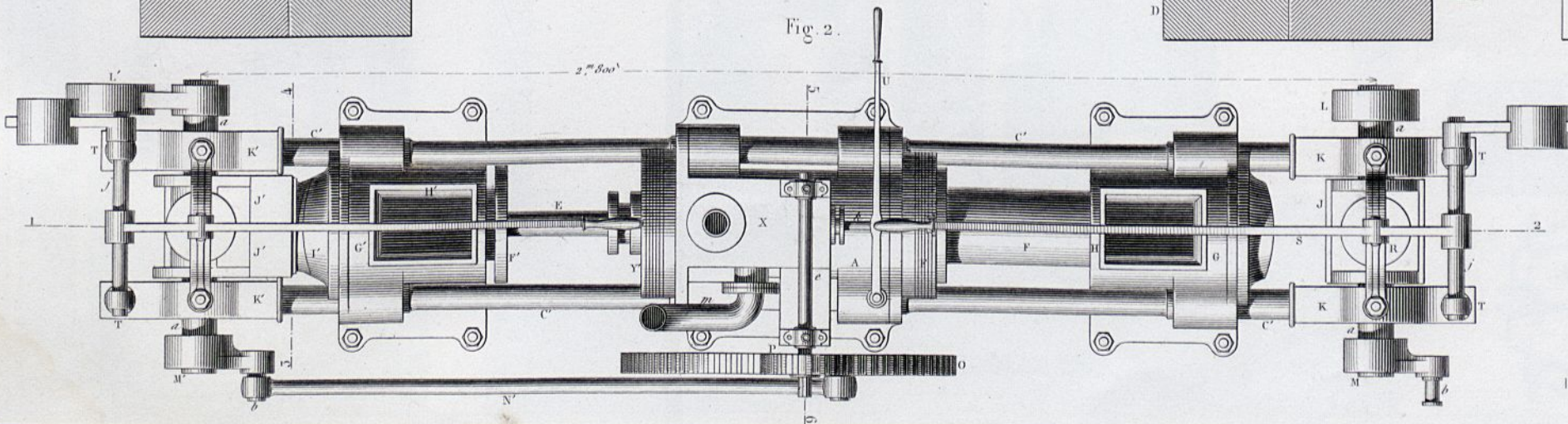

Fig. 2.

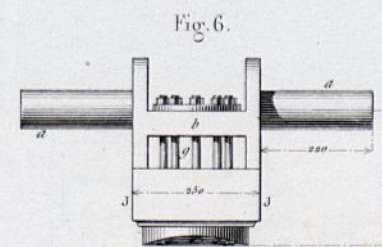
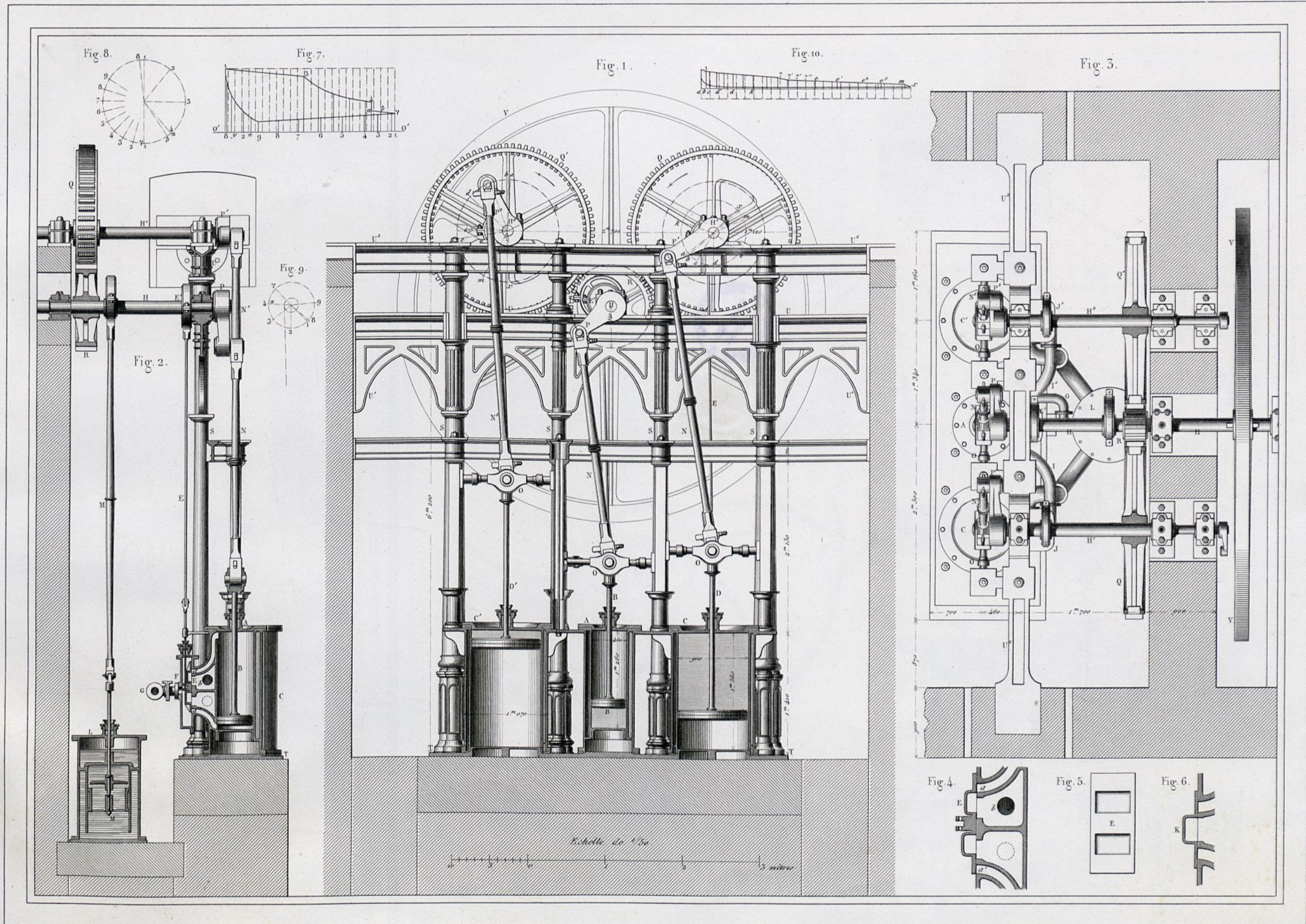

Fig. 6.

Eschelle de 1/15<sup>e</sup>







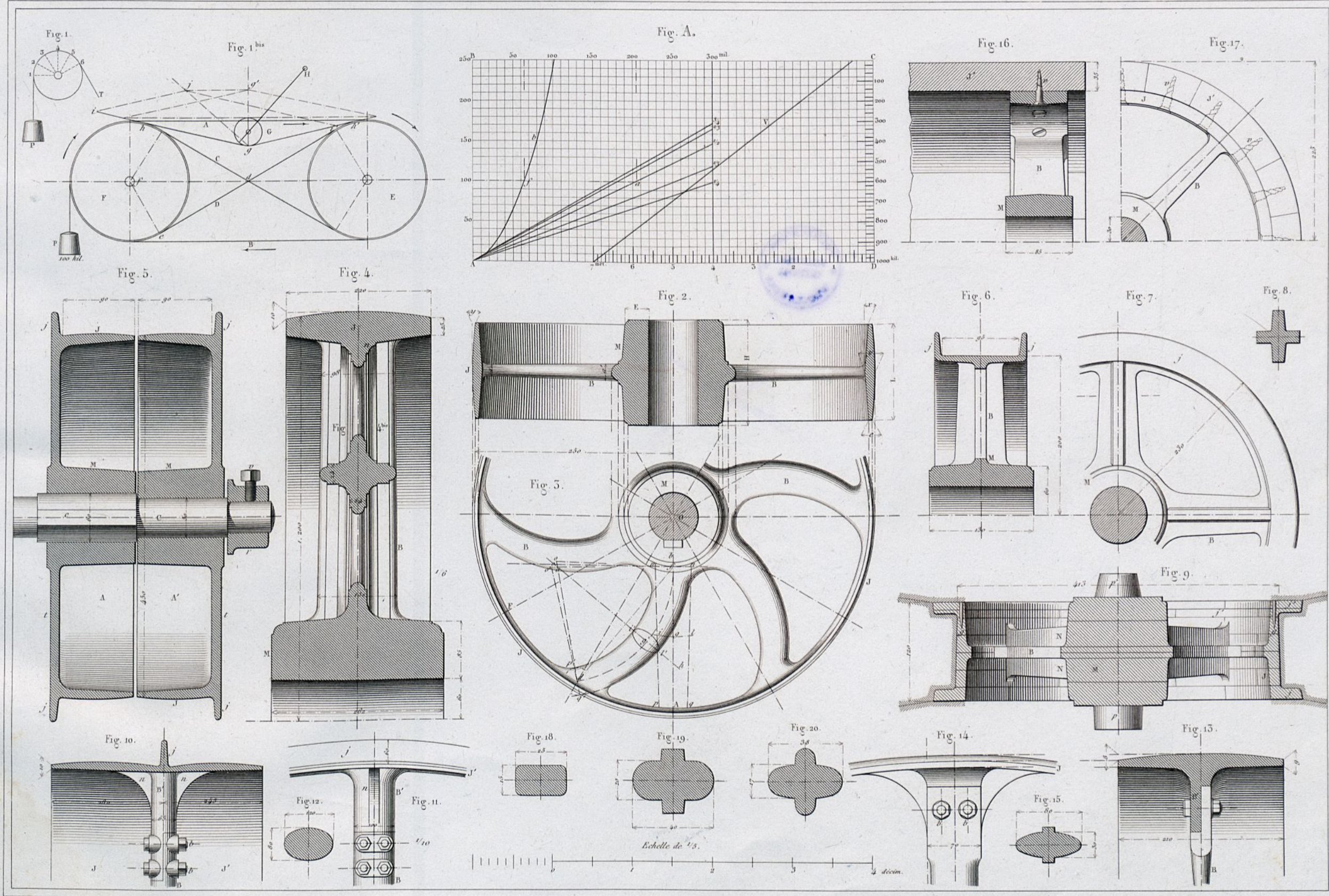





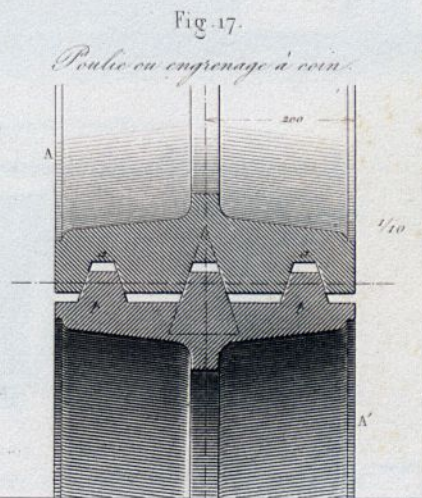
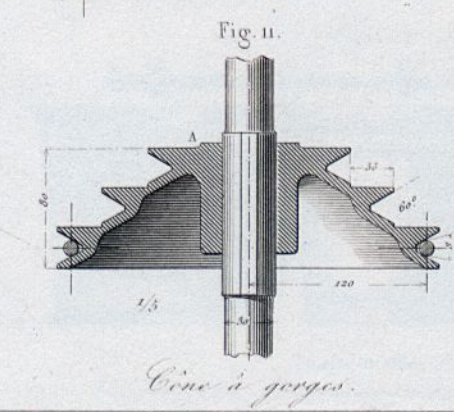
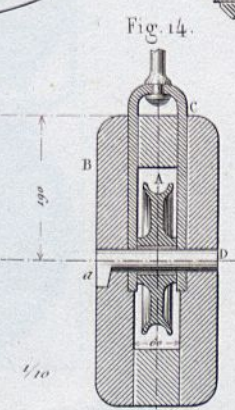
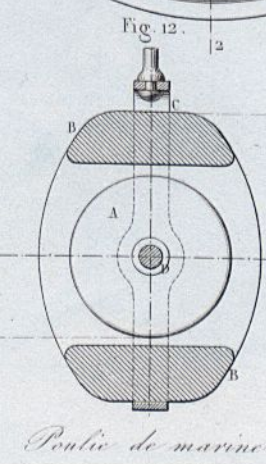
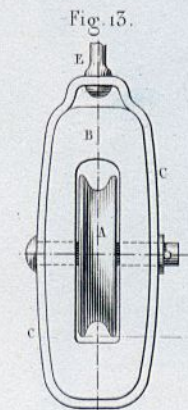
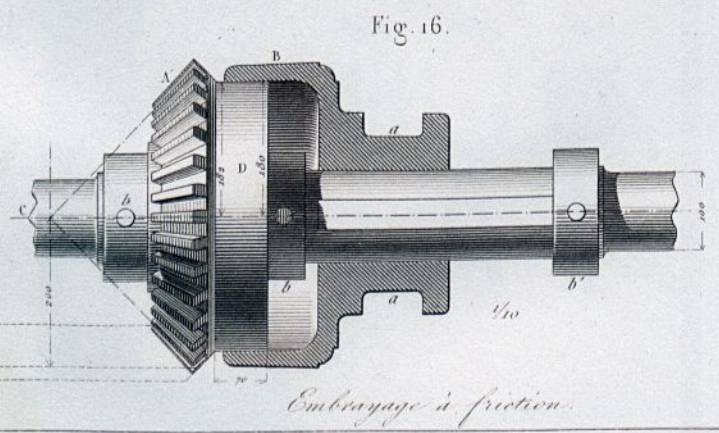
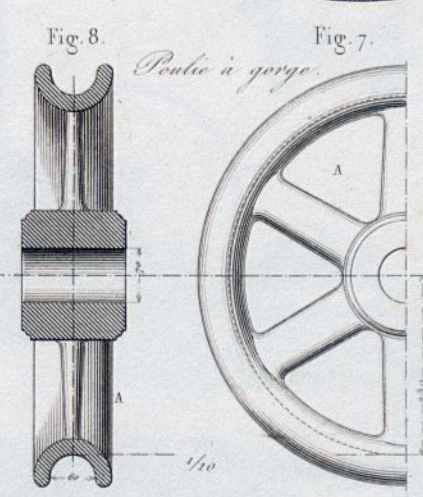
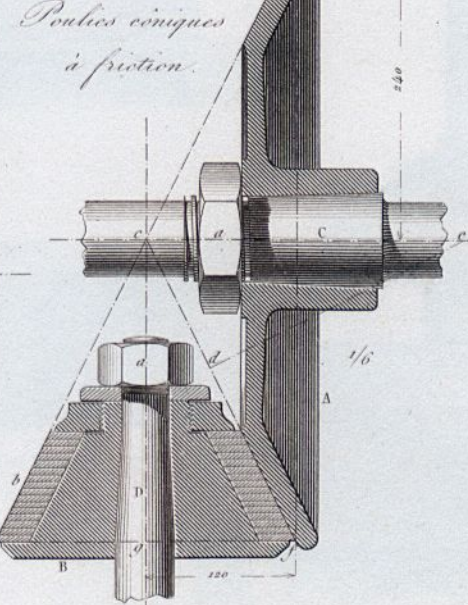
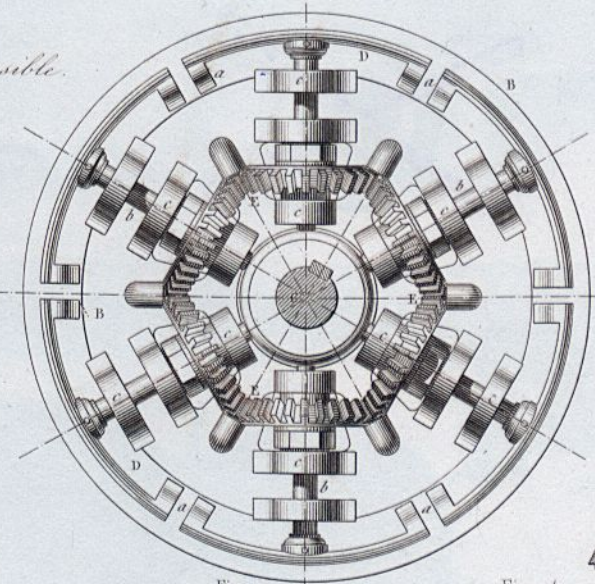
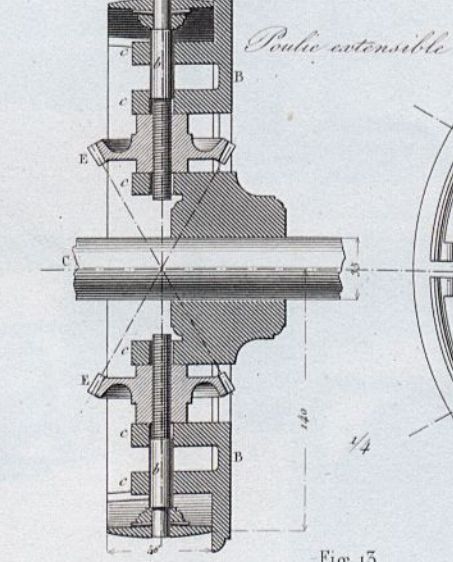
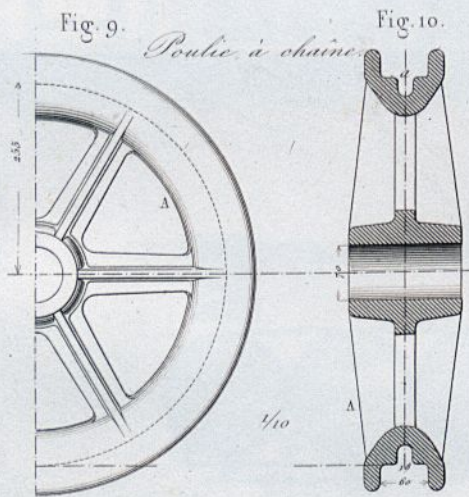
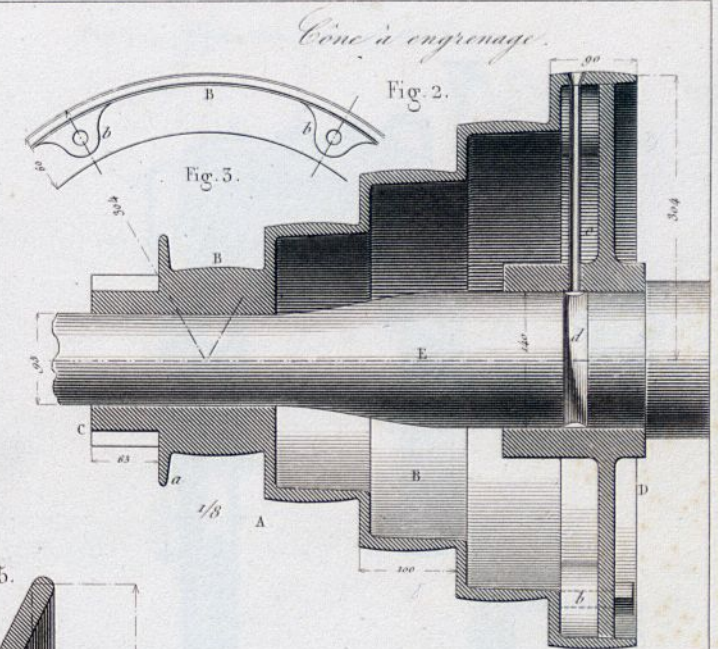
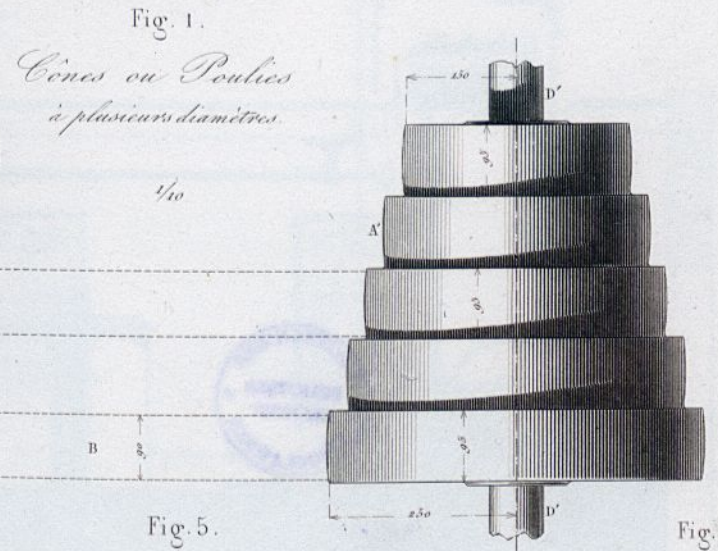
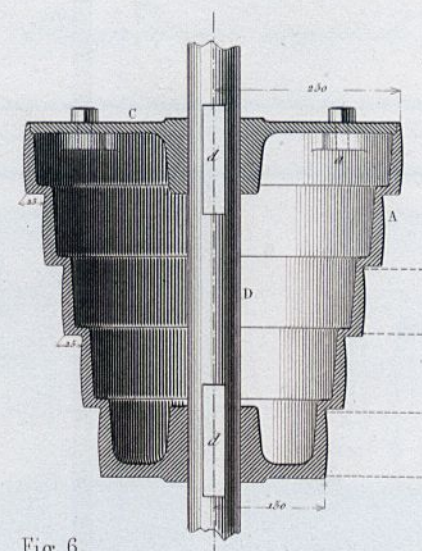
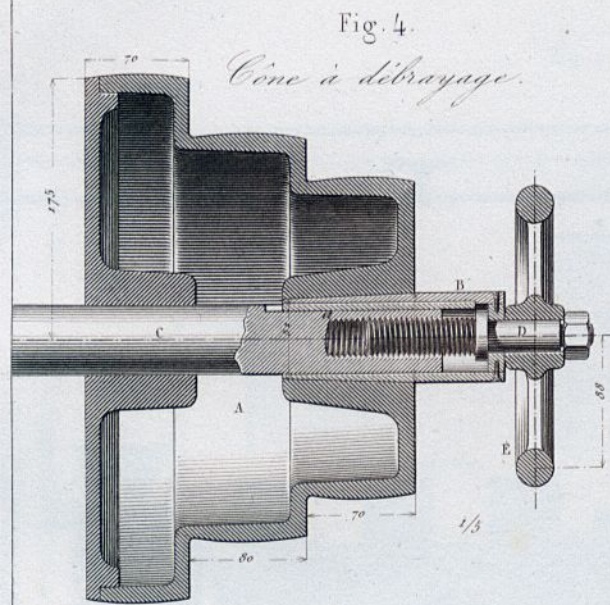



Fig. 2. Elevation des appareils.

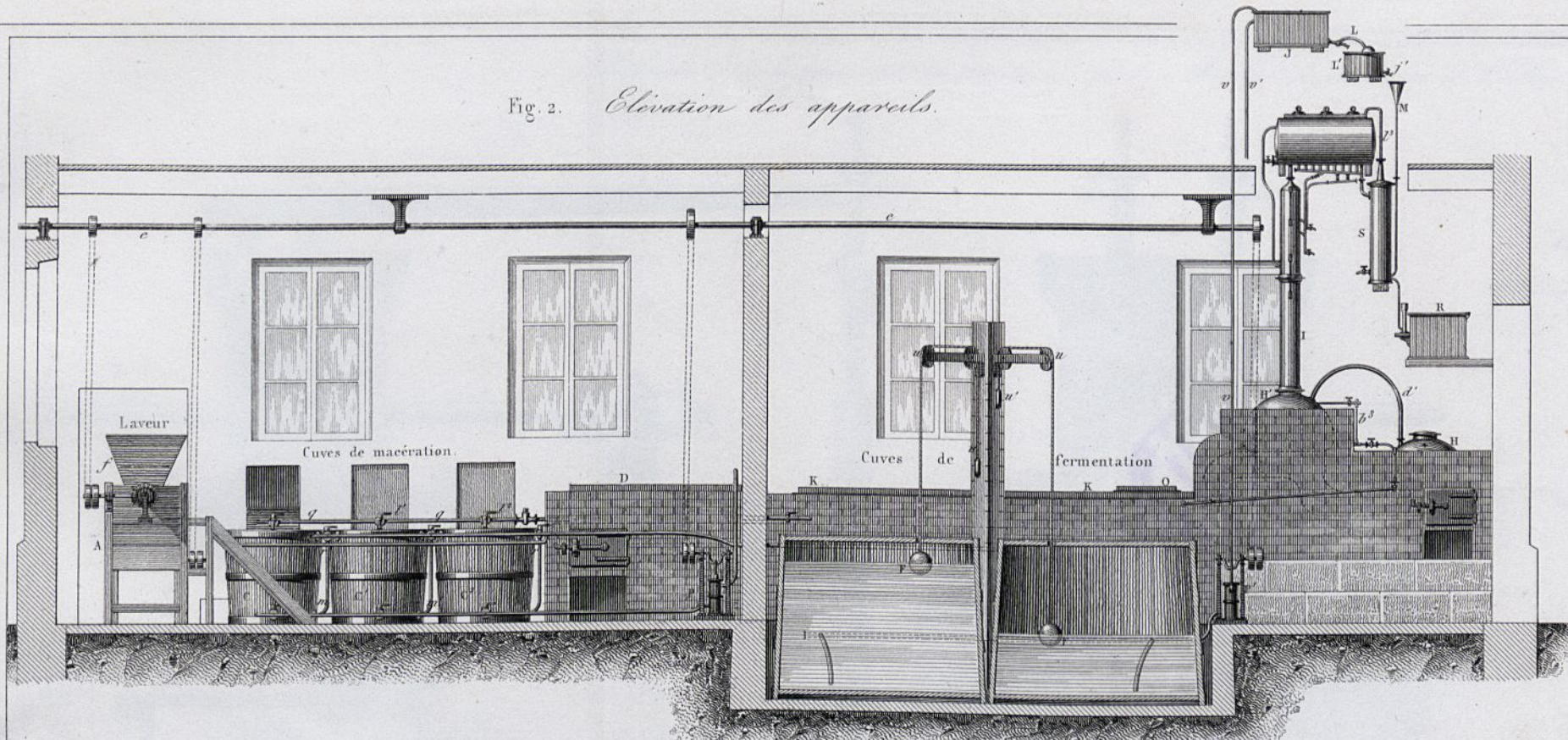

Fig. 4. Appareil de distillation.

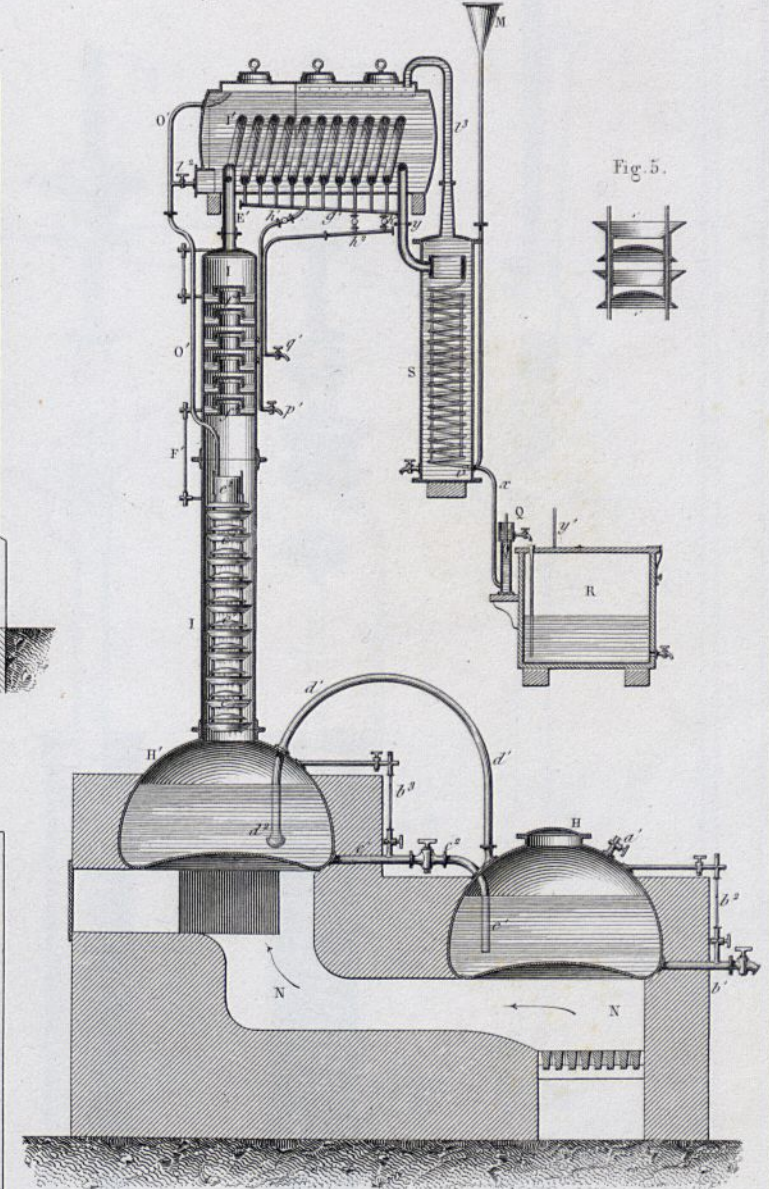

Fig. 1. Plan général de l'Usine.

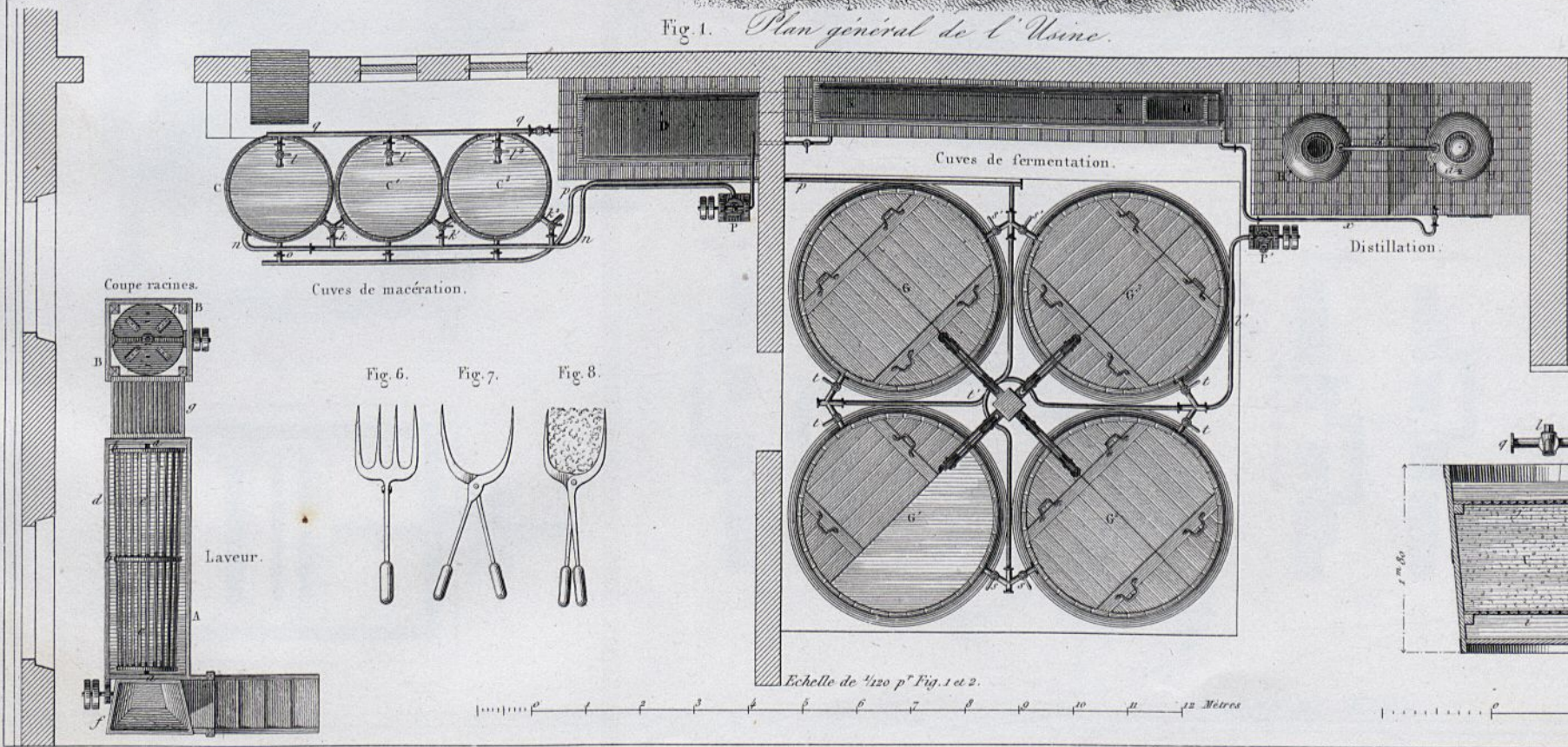
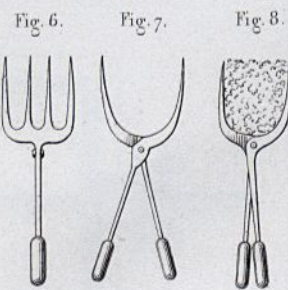
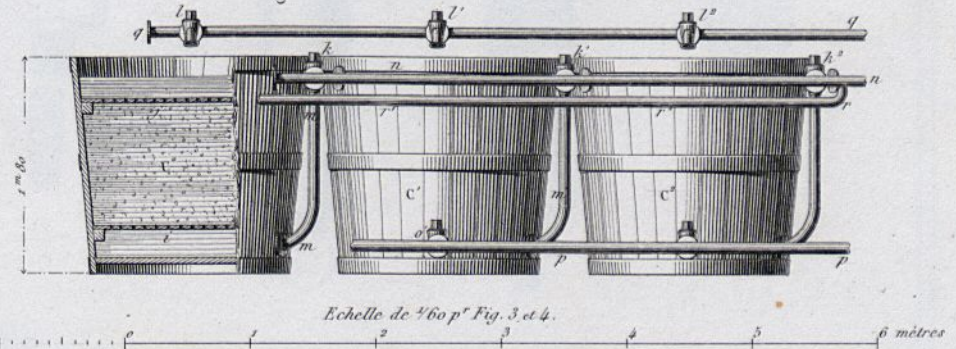
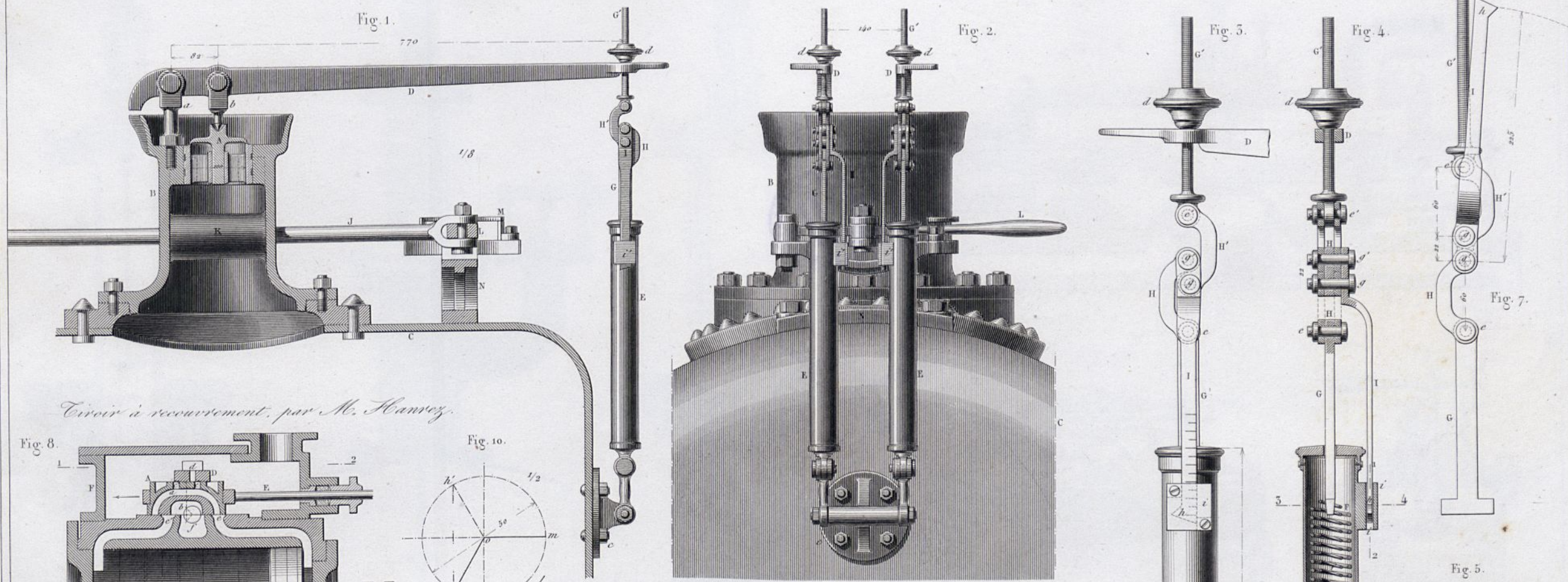

Fig. 3. Cuves de macération.





*Balance à échappement instantané, par M. M. Lemonnier & Vallée.*



*Circuit à recouvrement, par M. Hanvey.*

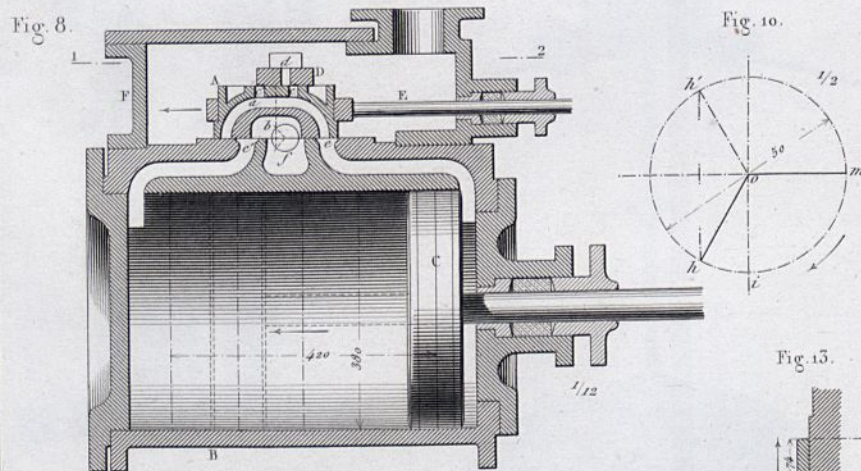
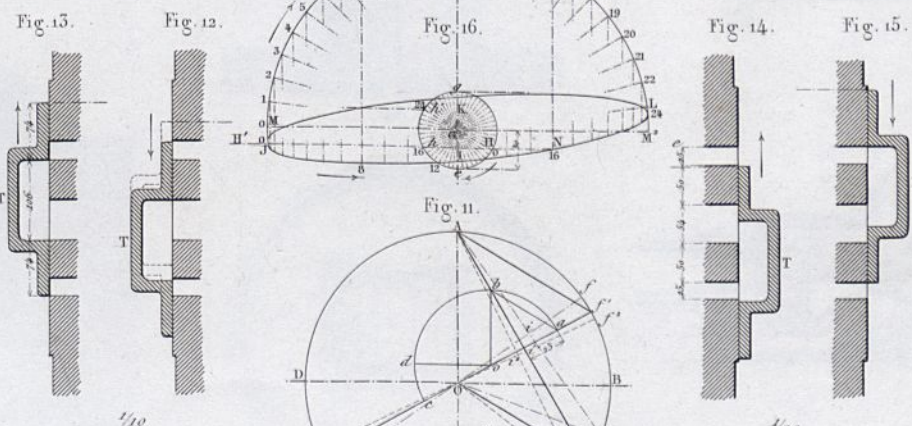
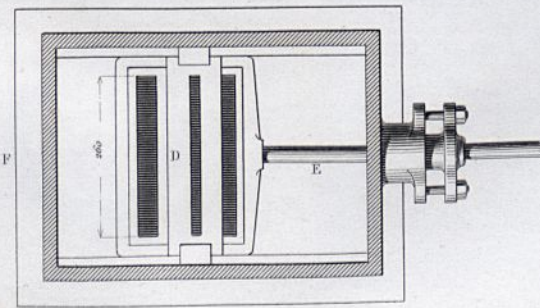
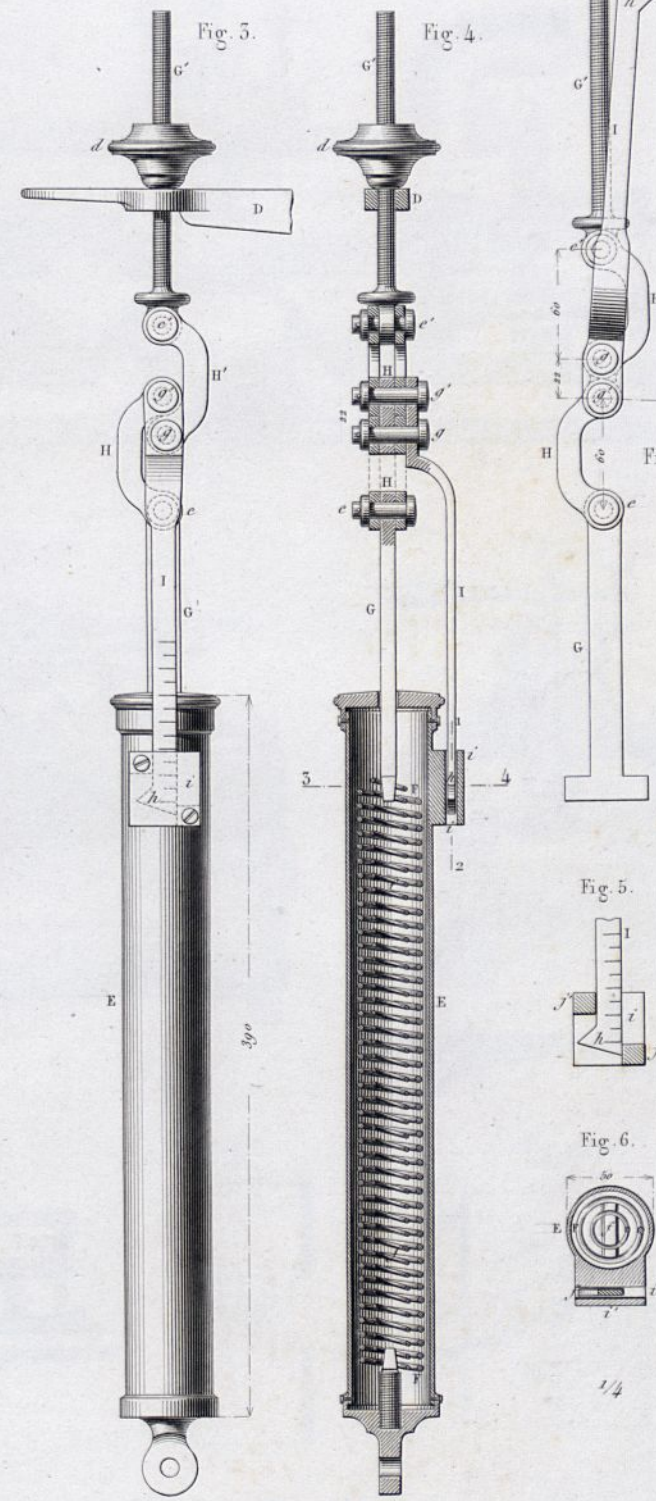

Fig. 9.



*Tracé pour déterminer les dimensions du tévier à détente fixe, par M. Valet.*





*Indicateur magnétique, par M. Lethuillier.*

*Tiroir variable, par M. Georges.*

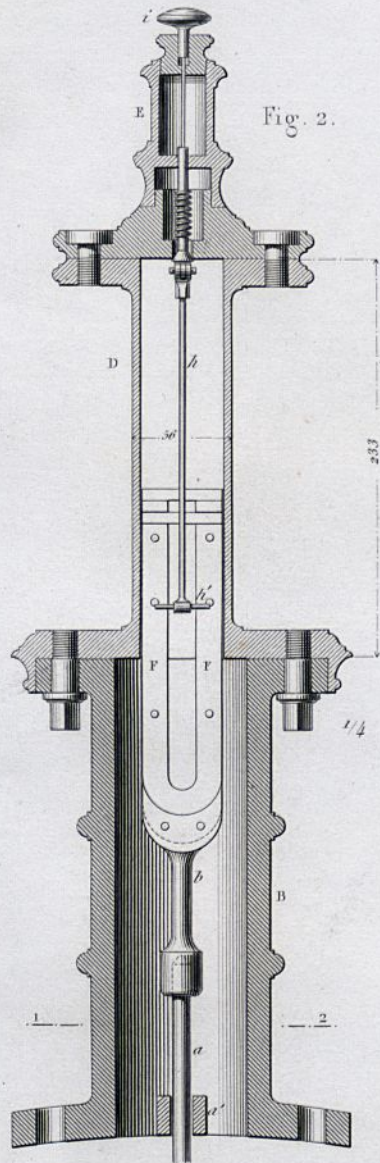

Fig. 2.

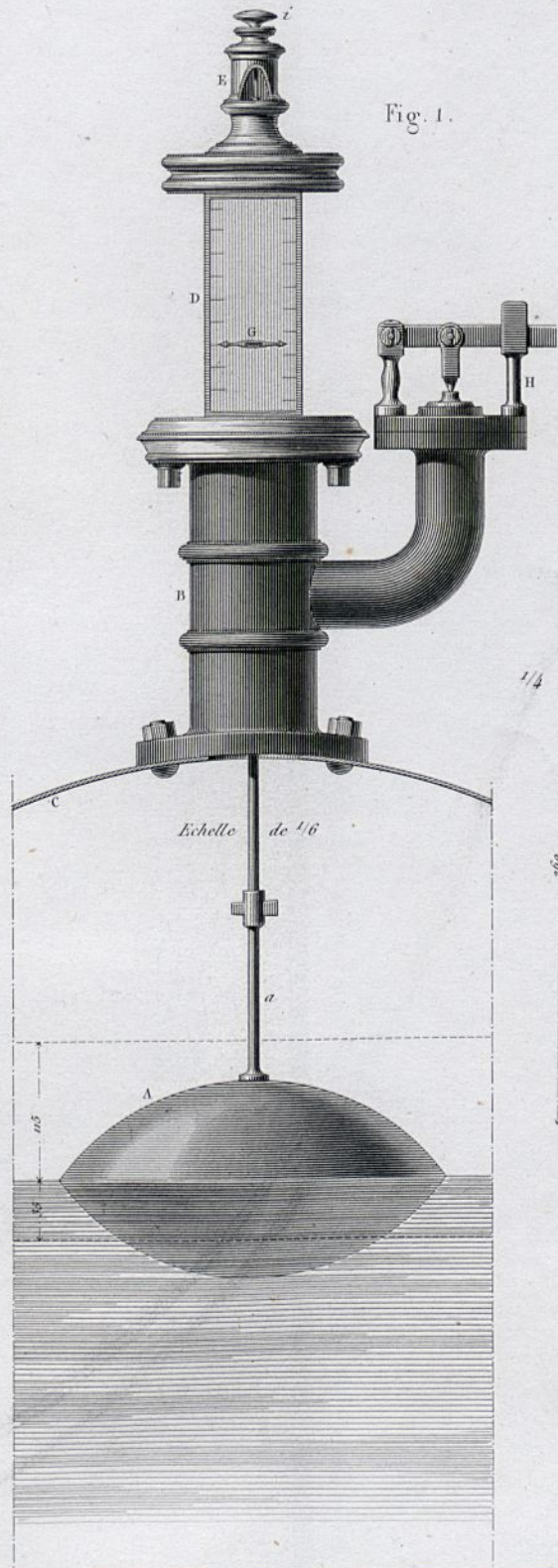

Fig. 1.

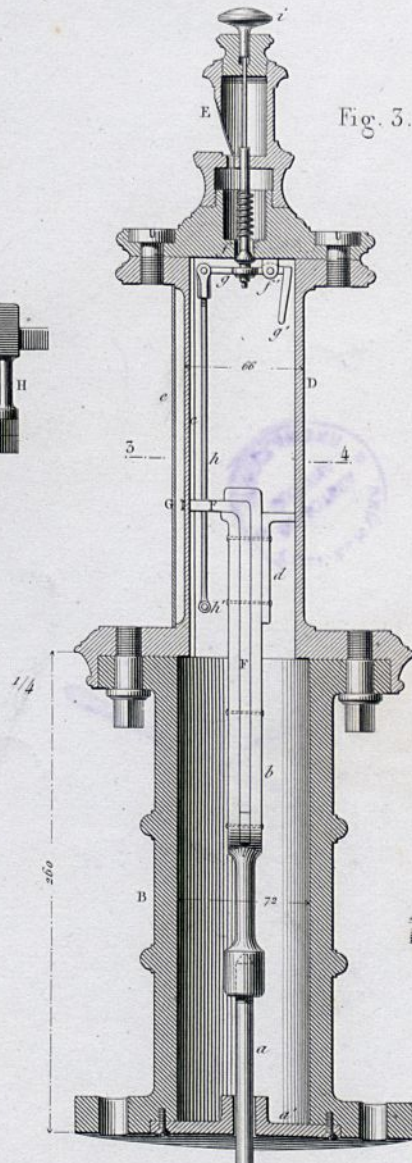

Fig. 3.

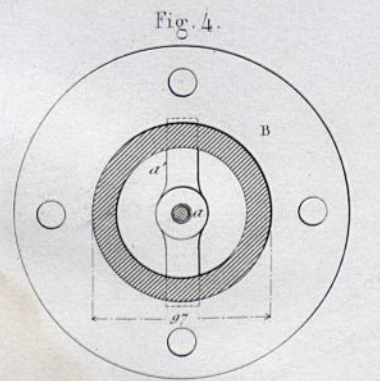

Fig. 4.

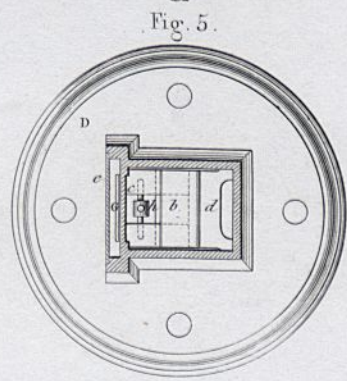

Fig. 5.

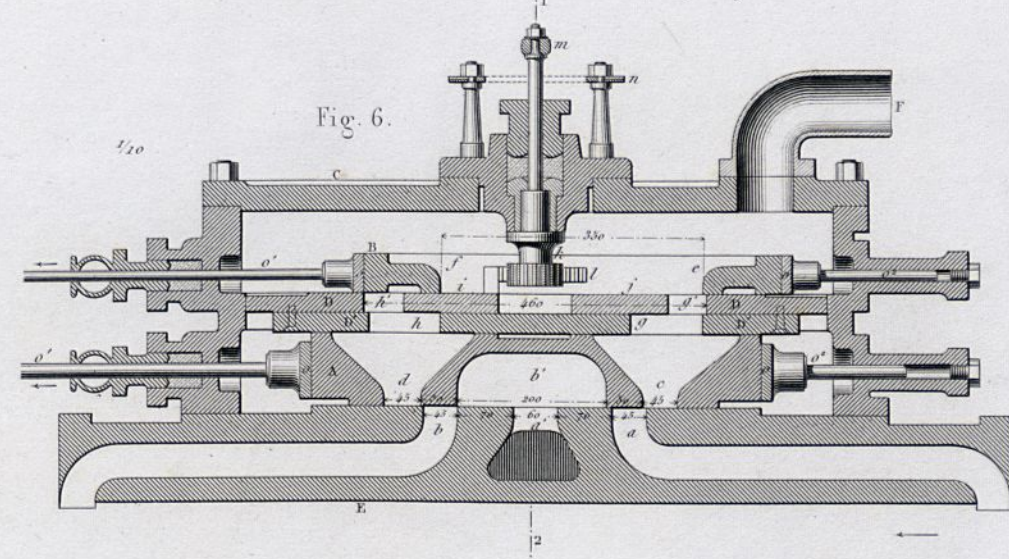

Fig. 6.

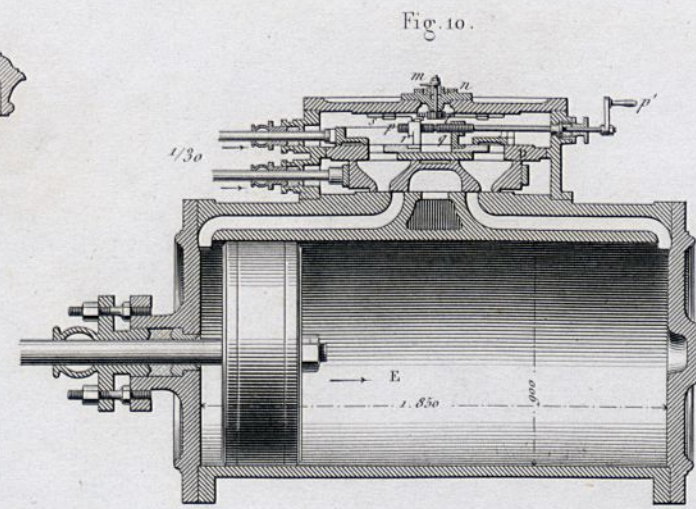

Fig. 10.

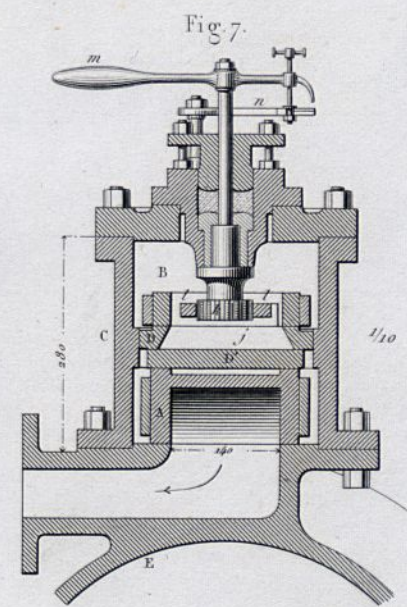

Fig. 7.

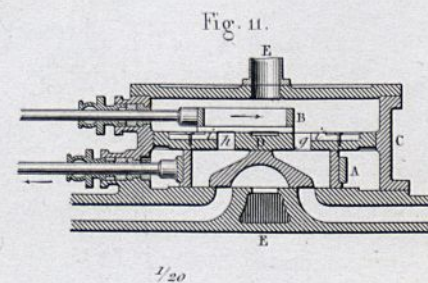

Fig. 11.

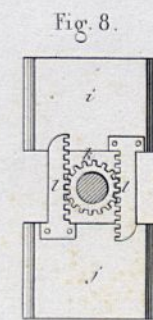

Fig. 8.

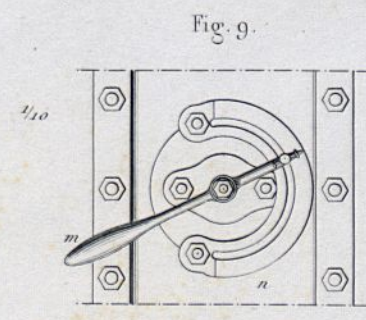
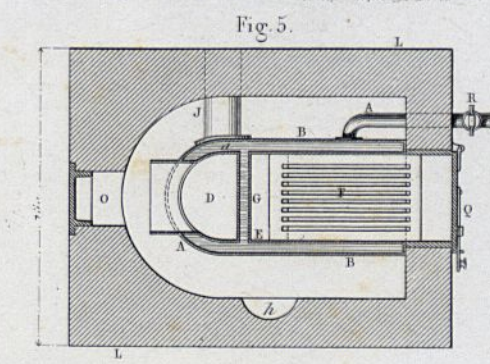
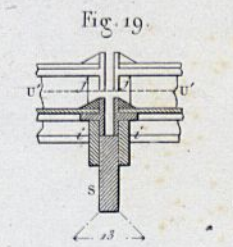
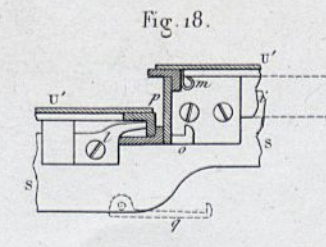
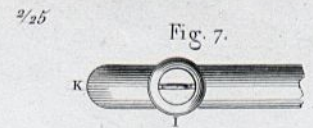
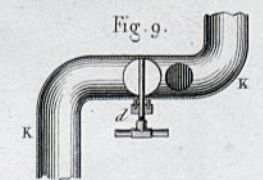
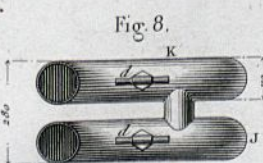
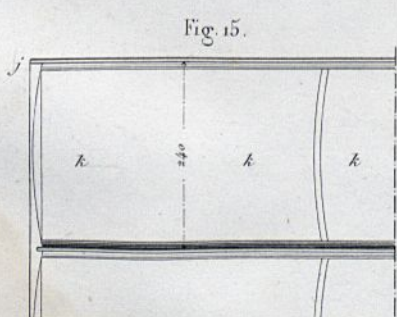
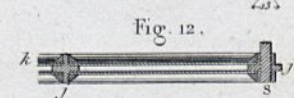
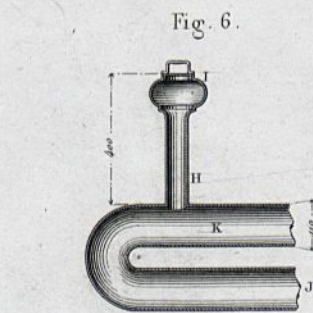
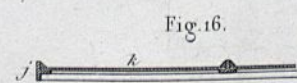
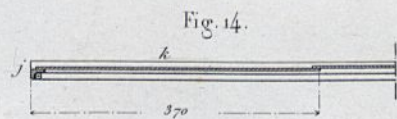
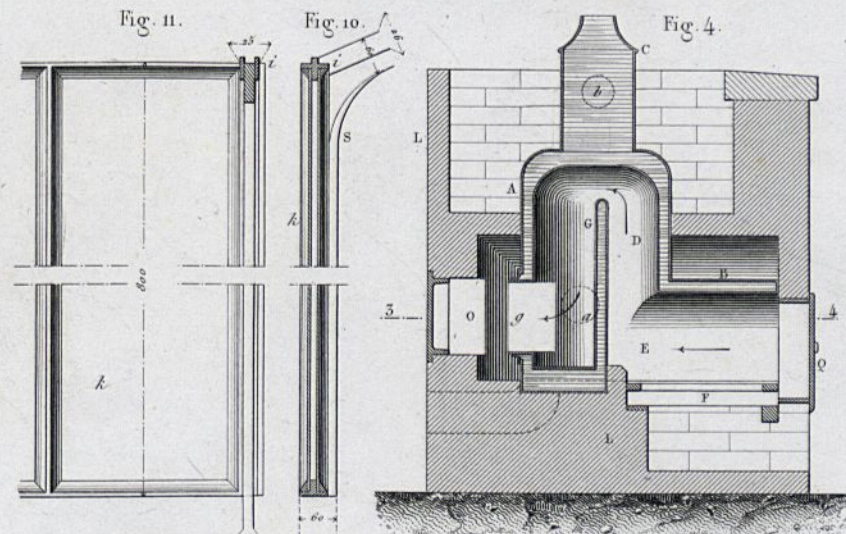
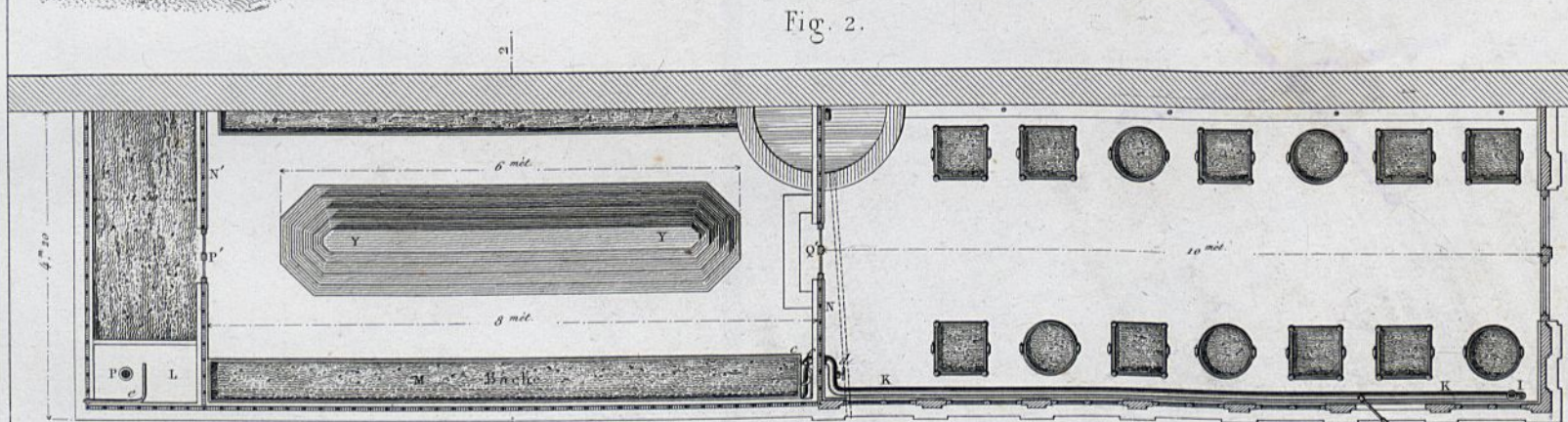
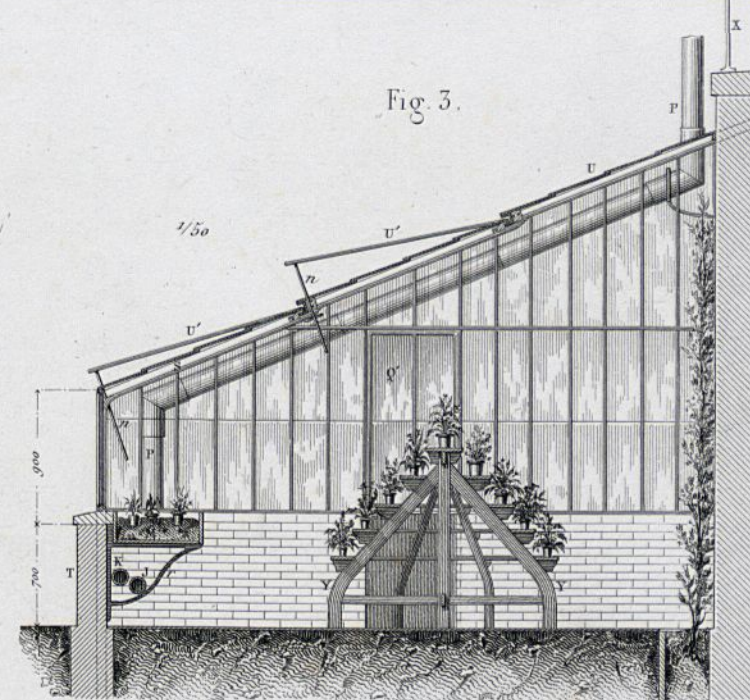
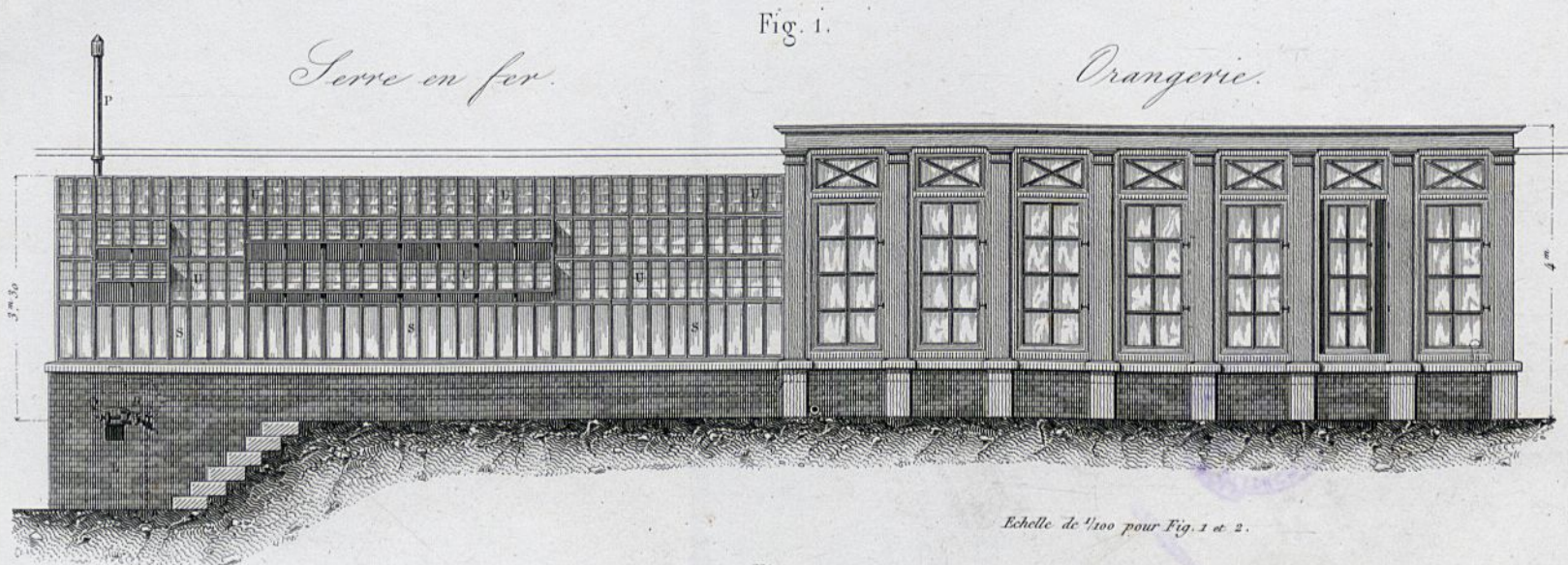

Fig. 9.













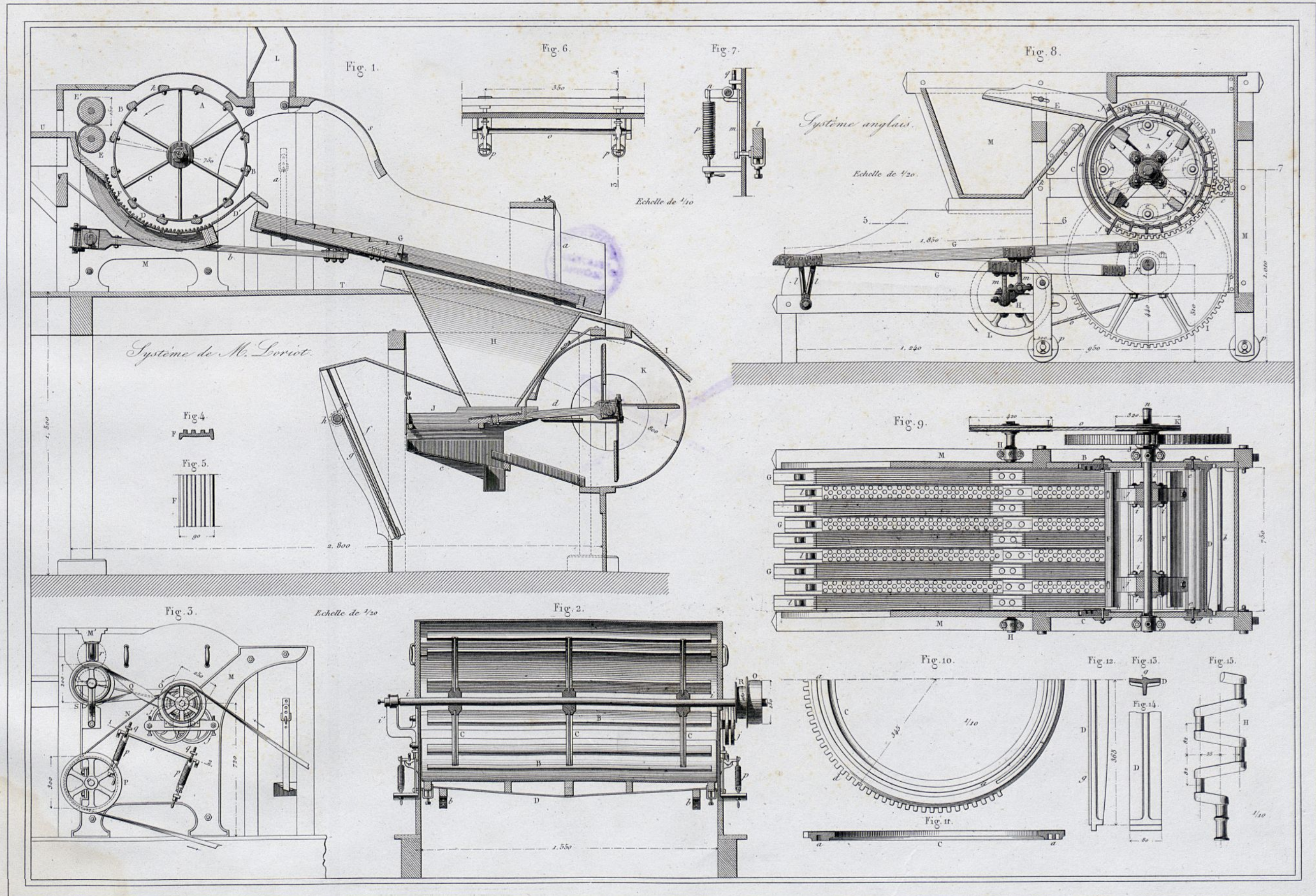















WOCIS W  
POLSKA  
BIBLIOTEKA GŁÓWNA  
R-96 m  
Archiwum